



**7<sup>th</sup> International Conference on Thermal Equipment,  
Renewable Energy and Rural Development**

**TE-RE-RD 2018**

**Drobeta Turnu Severin  
31 May - 2 June 2018**



# **7<sup>th</sup> International Conference on Thermal Equipment, Renewable Energy and Rural Development**

**TE-RE-RD 2018**

**ORGANIZERS:**

**University "POLITEHNICA" of Bucharest**  
Faculty of Mechanical Engineering and Mechatronics -  
Faculty of Biotechnical Systems Engineering -

**National Institute Of Research – Development For Machines And  
Installations Designed To Agriculture And Food Industry – INMA**

**Romanian Agricultural Mechanical Engineers Society – SIMAR**

## **PROCEEDINGS**

**Editors:**

*Prof.dr.ing. Gabriel-Paul NEGREANU*  
*Senior Lecturer dr.ing. Iulian-Claudiu DUȚU*

**Drobeta Turnu Severin – Romania**  
**31 May - 02 June 2018**

**ISSN 2359 – 7941**  
**ISSN-L 2359 – 7941**

**Editura POLITEHNICA PRESS**

**COVER: Gabriel-Paul Negreanu**

## SCIENTIFIC COMMITTEE

Dr. Atanas ATANASOV	BULGARIA
Prof. Viorel BĂDESCU	ROMANIA
Prof. Hristo BELOEV	BULGARIA
Prof. Alexandru DOBROVICESCU	ROMANIA
Dr. Cătălin DUMITRESCU	ROMANIA
Prof. Iliya ILIEV	BULGARIA
Prof. Ion V. ION	ROMANIA
Prof. Krzysztof JESIONEK	POLAND
Prof. Önder KABAŞ	TURKEY
Dr. Mihai MATACHE	ROMANIA
Dr. Igor KOVACEV	CROATIA
Prof. Edmond MAICAN	ROMANIA
Dr. Lucian MÂNDREA	ROMANIA
Prof. Jaroslaw MILESKI	POLAND
Prof. Prof. Mirjana LAKOTIC-PAUNOVIC	SERBIA
Prof. Constantin PANA	ROMANIA
Prof. Gigel PARASCHIV	ROMANIA
Prof. Ionel PÎŞĂ	ROMANIA
Dr. Ion PIRNĂ	ROMANIA
Prof. Tudor PRISECARU	ROMANIA
Prof. Violeta RASHEVA	BULGARIA
Prof. Kemal Çağatay SELVİ	TURKEY
Prof. Mariana Florentina ŞTEFĂNESCU	ROMANIA
Prof. Marija TODOROVIC	SERBIA
Prof. Rosen VASILEV	BULGARIA
Prof. Gheorghe VOICU	ROMANIA

## ORGANIZING COMMITTEE

<b>Chairman</b>	Prof. Lucian MIHĂESCU	ROMANIA
<b>Co-chairmen</b>	Prof. Sorin-Ştefan BIRIŞ	ROMANIA
	Prof. Gabriel-Paul NEGREANU	ROMANIA
	Dr. Valentin VLĂDUŢ	ROMANIA
	Dr. Iulian-Claudiu DUŢU	ROMANIA

## Members

Dr. Cristian-Gabriel ALIONTE	ROMANIA
Prof. Valentin APOSTOL	ROMANIA
Prof. Mircea BĂDESCU	ROMANIA
Dipl.Eng. Viorel BERBECE	ROMANIA
Dr. Cristina COVALIU	ROMANIA
PhD student ing. Iuliana GĂGEANU	ROMANIA
Dr. Mihaela-Florentina DUȚU	ROMANIA
Dr. Irina-Aura ISTRATE	ROMANIA
Dr. Elena POP	ROMANIA
Dr. Iulian VOICEA	ROMANIA

## Secretary

PhD student ing. Mariana MUNTEANU	ROMANIA
PhD student ing. Cristina Mihaela CIOBANU	ROMANIA
Dipl. ing. Gabriel GHEORGHE	ROMANIA
M.B.A. Andreea CRISTESCU	ROMANIA

## CONFERENCE SPONSORS



**SARTOROM**

Garantarea. Inovația. Excelența

Sos. Bucuresti - Magurele nr. 232

051434 Bucuresti 5, Romania

Tel: [+40 21 255 31 32](tel:+40212553132)

Fax: [+40 21 255 30 66](tel:+40212553066)



Calea Basarabiei nr. 96B

Loc. Huși, jud. Vaslui, Romania

Tel. / Fax. +40 335 426 839

## CONFERENCE PROGRAMME

<b>Thursday, May 31</b>	<b>Friday, June 01</b>	<b>Saturday, June 02</b>
	Breakfast	Breakfast
15.00-16.00 Registration of participants	08.30-09.30 Registration of participants	09.00-12.00 Networking
16.00-16.30 Opening ceremony	09.30-11.00 Oral presentations "Sections 1, 2"	12.00 Participants departure
16.30-18.30 Plenary session	11.00-11.30 Coffee break	
19.00-21.00 Welcome Cocktail	11.30-13.00 Oral presentations "Section 1, 2"	
	13.00-14.30 Lunch	
	14.30-16.30 Oral presentations "Section 1, 2"	
	16.30-17.00 Coffee break	
	17.00-18.30 "Workshop"	
	19.30-22.00 Conference dinner	

# CONTENTS

## SECTION 1: THERMAL EQUIPMENT AND RENEWABLE ENERGY

<b>1. The wastewater treatment using ozone technologies</b> B. K. Aliyarov, Sh.A. Bakhtaev, S. B.Abdreshova, B. Ongar, K. Jesionek .....	1
<b>2. Comparative analysis of possible solutions of using heat recovered from UPB-CHP plant</b> D. Ban (Tuțică), P. Tudor, E. Minciuc, V.-E. Cenușă .....	7
<b>3. Comparative analysis of two solar driven cycles under clear and cloudy sky conditions</b> B. Borcilă, C. Stanciu, M. Costea, S. Petrescu, M. Feidt .....	10
<b>4. The use of raw animal fats-butanol-diesel fuel blends at diesel engine</b> Al. Cernat, C. Pană, Gh. Lăzăroiu, N. Negurescu, Cr. Nuțu, A. Nicolici .....	17
<b>5. Experimental investigation of parabolic trough solar collector (PTC) performance for water desalination</b> D. M. H. Al-Shamkhee, E. O. A. Al-Zaini, Q. A. Abed.....	21
<b>6. Modeling of heating sector development with transition to biomass-based generation scenario till 2050 in Ukraine</b> A.Epik, V. Zubenko .....	27
<b>7. Capillary-porous cooling systems for melting units</b> A. A. Genbach, N. O. Jamankulova, I. K. Iliev.....	33
<b>8. Investigation of porous coverage in cooling systems for turbine equipment elements</b> A. A. Genbach, D. Yu. Bondartsev, I. K. Iliev .....	37
<b>9. Heating with heat pipes</b> A. A. Genbach, K. Olzhabayeva, K. Shokolakov, I. K. Iliev .....	43
<b>10. Comparative analysis of the existing dust collectors with the designed capillary porous dust collector with controlled geometry of micro-channels</b> A. Genbach, K. Shokolakov, A. Terziev .....	49
<b>11. Application of economizer in biomass boiler house in Boryspil airport: case study</b> S. Heletukha .....	55
<b>12. Performance analysis of a biogas-fueled gas turbine cogeneration system</b> I. V. Ion, F. Popescu, S.L. Paraschiv, S. Paraschiv .....	59
<b>13. Integration of micro-cogeneration systems into existing buildings</b> A. Ionescu, L. Barelli, Gh. Lăzăroiu .....	63

<b>14. Thermal energy storage for micro cogeneration systems</b>	
A. Ionescu, L. Barelli, Gh. Lazaroiu .....	69
<b>15. Correction of pollution emissions measurements on fuel combustion</b>	
<u>I. Iordache</u> , E. Pop, L. Mihăescu .....	75
<b>16. Energy efficiency of buildings – legislation in the Republic of Serbia</b>	
M. Kovačević, I. Tasić .....	79
<b>17. Energy efficiency of the receiver of solar energy in the territory of the Republic of Serbia</b>	
M. Kovačević, I. Tasić, J. Pekez .....	85
<b>18. Experiments on the energy characteristics of poultry manure</b>	
Gh. Lăzăroiu, L. Mihăescu, I. Pișă, G. Negreanu, D. Ciupăgeanu, A. Bondrea, V. Berbecu, V. Galbură, M. Tîrșu .....	91
<b>19. Evaluation of erosion risk for a cogeneration steam turbine when steam parameters change</b>	
G. Negreanu, I. Oprea, R. Băcanu, D. Baciu.....	95
<b>20. The use of raw animal fats-butanol-diesel fuel blends at diesel engine</b>	
Al. Cernat, C. Pana, Gh. Lazaroiu , N. Negurescu, C. Nutu, A. Nicolici.....	101
<b>21. A research on fuelling a car diesel engine with liquefied petroleum gas</b>	
N. C. Nutu, C. Pana, N. Negurescu, Al. Cernat, D. Fuiorescu, L. Nemoianu.....	105
<b>22. Low power cogeneration installation using solid vineyard waste biomass</b>	
I. Oprea .....	111
<b>23. Modelling of desulphurization process with the scope of SO2 emissions decrease and increase of synthetic gypsum quality</b>	
T. Prisecaru, M.M. Prisecaru, R. Lisnic .....	115
<b>24. Energetic performance increase of an engine-electric generator group</b>	
P. Radoescu, C. Pana, N. Negurescu, Al. Cernat, C. Nutu.....	121
<b>25. On the way to approximate diesel engines emissions: a literature review</b>	
B. Radu, Al. Racovitză.....	125
<b>26. Results from an energy audit of a joint-stock company “Medica AD”, Bulgaria</b>	
V. Rasheva, V. Kamburova, M. Velikanov .....	129
<b>27. The use of low temperature geothermal energy at historical buildings – case study for a hotel</b>	
P. Tudor, V.E. Cenușă, D. Ban (Tuțică), I.C. Duțu .....	135
<b>28. Increasing the efficiency of thermal collectors by using thermal tubes</b>	
Kr. Uzuneanu .....	139

<b>29. Energy from biomass obtaining in the gasification process – modular construction of the gasification machine</b>	
G. Wieczorkiewicz, K. Jesionek, M. Rychlik, R. Roszak.....	143
<b>30. Analytical heat conduction solution for two-dimensional cartesian slab under the effect of a laser pulse</b>	
W. A. Abd Al-wahid, Q. A. Abed.....	149
<b>31. Providing the isolated localities with various energy types at the acceptable cost</b>	
Ul. Zhalmagambetova, Al. Mergalimova, B. Aliyarov .....	155



## SECTION 2: RURAL DEVELOPMENT AND RENEWABLE ENERGY

- 32. Biomass conversion by pyrolysis**  
I.D. Alexandru ..... 159
- 33. Technology for the recovery of zootechnical waste through the process of anaerobic digestion**  
V. Bălan, I. Voicea, I. Găgeanu, D. Cujbescu, C. Persu, M. Dilea,  
N. Ungureanu, C.I. Moga ..... 165
- 34. Superior valorification of lentil flour and application in bread products**  
A.E. Boeriu, Cr.M. Canja, Ad. Măzărel ..... 171
- 35. Experimental researches on determining the qualitative working indices for vegetable and leguminous plants sowing machine on sandy soils**  
Gh. Bolintineanu, D. Cujbescu, C. Persu, I. Găgeanu, I. Voicea, G. Gheorghe,  
L. Vlăduțoiu, I. Dumitru, R. Oprescu, N. Ungureanu, Cr. Vlad ..... 177
- 36. Printers contribution to indoor level of particulate matter and solution to reduce this emissions**  
A. Bordaș, I. Istrate, M.G. Munteanu ..... 183
- 37. Research regarding the process of medicinal herbs drying technology**  
I.L. Caba, E.A. Laza, V. Vlăduț, A. Păun, M. Cristea ..... 189
- 38. The relations between Cultural Landscapes, Open Source Hardware and Open Innovation in Rural Development**  
Al. Calcatinge ..... 193
- 39. Environmental protection in food industry through food waste control**  
C.M. Canja, Ad.E. Boeriu, A. Măzărel ..... 199
- 40. Aspects on the working process of the cement mills and dimensional characteristics of the raw material**  
Cr. Ciobanu, Gh. Voicu, M.L. Toma, P. Tudor ..... 205
- 41. Wastewater treatment by flotation using magnetic nanomaterials**  
Il.C. Covaliu, A. Bruneau, St. Kermade, G. Paraschiv, S.Șt. Biriș, C.I. Moga,  
G. Petrescu, M.G. Matache, I. Filip ..... 211
- 42. Modeling, simulation and study of loads and deformations in traction devices**  
A.C. Cristescu, L. Popa, V. Ștefan, Al. Anghel ..... 215
- 43. Considerations on the use of drones in precision agriculture**  
D. Cujbescu, C. Persu, I. Găgeanu, I. Voicea, G. Gheorghe, L. Vlăduțoiu,  
I. Dumitru, R. Oprescu, M. Cristea ..... 221
- 44. Applications and perspectives of using drones in precision agriculture**  
D. Cujbescu, C. Persu, I. Găgeanu, I. Voicea, G. Gheorghe, L. Vlăduțoiu,  
N. Ungureanu, Cr. Vlad ..... 227
- 45. A review regarding models which predict landfill gas generation**  
M. Dincă, M. Ferdeș, B.Șt. Zăbavă, N. Ungureanu, G. Moiceanu, M. Ionescu ..... 233

<b>46. Ozone and nitrogen oxides production in sterilized tap water by an ozone generator type OZONFIX 8G</b>	
M. Dincă, M. Ferdeş, G. Paraschiv, B.Şt. Zăbavă, N. Ungureanu, L. Constantin .....	239
<b>47. Technology for cultivating bicolor sorghum for food or energetic purposes</b>	
I. Dumitru, I. Voicea, V. Vlăduţ, I. Găgeanu, R. Oprescu, C. Persu, N. Ungureanu, V. Bălan, M. Cristea .....	245
<b>48. Investigation of a digital hydraulic actuation system for a waste baling press</b>	
I.C. Duţu, S.Şt. Biriş, E. Maican, P. Tudor, R.I. Rădoi .....	251
<b>49. Motor wheel modelling of a tractor</b>	
M.Fl. Duţu, M. Begea, I.C. Duţu, Al. Cîrîc, G. Simion .....	257
<b>50. The growth behavior of E. COLI K12-MG1655 and the consumption of the substrate in different sugar concentrations culture media</b>	
M. Ferdeş, M. Dincă, B.Şt. Zăbavă, G. Paraschiv .....	263
<b>51. Benefits of using additives in the production of biomass pellets</b>	
I. Găgeanu, Gh. Voicu, D. Cujbescu, C. Persu, G. Gheorghe, I. Voicea .....	269
<b>52. Considerations on improving biomass pellets quality by using additives</b>	
I. Găgeanu, Gh. Voicu, D. Cujbescu, C. Persu, O. Pandia .....	273
<b>53. Study on the automatic adjustment of the constructive and functional parameters of the vibratory tillage tools</b>	
N.E. Gheorghişă, S.Şt. Biriş, N. Ungureanu, M. Ionescu, M.G. Munteanu .....	277
<b>54. Considerations on sage culture technology and essential oils obtaining</b>	
I. Grigore, E. Sorica, Cr. Sorică, A.I. Grigore, L. Vladuţoiu .....	281
<b>55. Design concepts of mobile robots for agriculture</b>	
G. Ipate, V. Moise, S.Şt. Biriş, Gh. Voicu, F. Ilie, G.Al. Constantin .....	285
<b>56. Studies and research regarding the technology of extracting volatile oils from medicinal herbs</b>	
E.A. Laza, I.L. Caba, A. Păun, V. Vlăduţ .....	291
<b>57. The role of eco – marketing strategies concerning sustainable development of Romanian tourism</b>	
A. Măzărel, L. Cismaru, A.E. Boeriu, Cr.M. Canja .....	297
<b>58. Theoretical elements for the constructive optimization of the agro-food products recipients</b>	
G. Milian, S.Şt. Biriş, V. Moise .....	303
<b>59. Aspects regarding Miscanthus grinding process for peletization/briquetting</b>	
G. Moiceanu , G. Paraschiv, Gh. Voicu, M. Dincă, V. Vlăduţ, I. Găgeanu .....	309
<b>60. Structural and cinematic analysis of the elevating mechanism of a utility vehicle's shutter</b>	
V. Moise, L. Dudici, Al. Rotaru, Şt. Moise .....	315

<b>61. Innovative model of vertical dryer for cereal seeds</b>	
A. Muscalu, P. Cârlescu Petru, Cr. Sorică, Vl. Arsenoia, M. Bîrsan .....	321
<b>62. Considerations on the construction and operation of a device for soil modelling in interrupted furrows for weeding crops</b>	
M.R. Oprescu, S.Şt. Biriş, I. Voicea, D. Cujbescu, C. Persu, I. Găgeanu, V. Vlăduţ, I. Dumitru, M. Cristea .....	327
<b>63. Methods of arranging the knives on the chopping drum from the forage harvester</b>	
R. Popa, V. Popa, S.Şt. Biriş.....	333
<b>64. Separation by size and extraction of valuable compounds from medicinal plants of nettle</b>	
A. Pruteanu, L. David, M. Ferdeş, I. Voicea, M. Niţu, B.Şt. Zăbavă .....	337
<b>65. Robots for intervention and evaluation of the situation in disaster areas</b>	
R.I. Rădoi, Şt. Trache, A. Mocioi, I.C. Duţu .....	343
<b>66. Evaluation of environmental impact by using control lists</b>	
C.O. Rusănescu, S.Şt. Biriş, G. Paraschiv, M. Begea, Gh. Voicu, M. Rusănescu, Al. Cîrîc, D. Stoica, M.Cr. Țucureanu .....	349
<b>67. Methods of environmental impact assessment</b>	
C.O. Rusănescu, M.Cr. Țucureanu .....	353
<b>68. Wood-burning stoves with high efficiency</b>	
V.V. Safta, M.L. Toma, B.Şt. Zăbavă, A. Boureci, V. Ciucă .....	357
<b>69. Electro-hydraulic stand for testing reliability of special materials</b>	
I.Al. Sărăcin, I.C. Duţu, Gh. Voicu .....	363
<b>70. Air quality monitoring for bakery units</b>	
G.Cr. Simion, M.Fl. Duţu .....	369
<b>71. Noise measurement and directional curve determination for an portable power generator</b>	
Cr. Sorică, E. Sorică, A.I. Grigore, M.R. Oprescu .....	373
<b>72. Effects of wheat seeds characteristics on roller milling process – a review</b>	
M.E. Ştefan, Gh. Voicu, G.Al. Constantin, M. Munteanu, M. Ionescu .....	379
<b>73. Sort variation process of power flow in a conical sieve oscillating</b>	
D. Stoica, Gh. Voicu, I.C. Duţu, M.Fl. Duţu .....	385
<b>74. Changes in bulk density as indicator of soil compaction</b>	
N. Ungureanu, V. Vlăduţ, S.Şt. Biriş, B.Şt. Zăbavă, M. Dincă .....	391
<b>75. Reuse of wastewater for irrigation, a sustainable practice in arid and semi-arid regions</b>	
N. Ungureanu, V. Vlăduţ, M. Dincă, B.Şt. Zăbavă, I. Voicea, M. Cristea .....	397

<b>76. Study concerning technologies for obtaining oil from grape seeds</b> C. Vasilachi, S.Șt. Biriș .....	403
<b>77. Rural policies in Romania prior and after Europe 2020</b> O. Vlăduț, P. Mihai, M.Fl. Duțu, I.C. Duțu, D.I. Vlăduț .....	409
<b>78. System for the extraction of bioactive compounds from plants with bio-insecticide action in organic farming</b> I. Voicea, I. Găgeanu, D. Cujbescu, C. Persu, V. Bălan, L. Săvoiu .....	413
<b>79. Flotation process in wastewater treatment</b> I. Voicea, C.I. Moga, I. Găgeanu, M. Matache, V. Vlăduț, M. Cristea .....	419
<b>80. “Plant stress” – the first indication that a landfill gas (LFG) migration is taking place near the MSW landfill</b> Gh. Voicu, D. Vieru, L. Toma, P. Tudor .....	425
<b>81. Equipments used in biomass pelletization process – a review</b> Gh. Voicu, M. Dincă, B.Șt. Zăbavă, N. Ungureanu, I. Găgeanu, P. Tudor .....	431
<b>82. Wastewater disinfection by chlorination, ozonation and ultraviolet (UV) – a review</b> B.Șt. Zăbavă, Gh. Voicu, G. Paraschiv, M. Dincă, N. Ungureanu, M. Ionescu .....	437
<b>83. Factors that influence the efficiency of the decanting process – a review</b> B.Șt. Zăbavă, Gh. Voicu, M. Dincă, N. Ungureanu, M. Ferdeș .....	441

### **SECTION 3: DYNAMICS OF THE RATIO ELECTRICITY VERSUS HEAT OBTAINED FROM RENEWABLE SOURCES**

<b>84. Modeling renewable energy share dynamics</b> D.A. Ciupăgeanu, Gh. Lăzăroiu.....	445
<b>85. Simulation of a small scale renewable energy system</b> D.A Ciupăgeanu, Gh. Lăzăroiu, A. Micu .....	451
<b>86. Nanostructured materials for energy valorisation of used oils</b> M. Dragne, I. Pîșă, C. Covaliu, G. Lazaroiu .....	457
<b>87. Velocity distribution in simulated exhale air flow, with virtual breathing thermal manikins</b> M. Ivanov, S. Mijorski .....	461
<b>88. Holistic of renewable energy sources impact and solutions for interconnection to the power system</b> Gh. Lăzăroiu, C. Panait, L. Mihăescu, M. Tîrșu, V. Dumbravă, G. Negreanu, I. Pîșă .....	467
<b>89. Bodies shape influence on the effects produced in liquid environments</b> L. Mândrea, C.A. Băbuțanu, C. Constantinescu .....	473
<b>90. Comparative analyses of air flow characteristics, through two variants of prototyped device for fine dust particles concentration measurement</b> S. Mijorski , M. Ivanov .....	477
<b>91. About the problems in lightning protection in photovoltaic power stations</b> I. Nedelchev .....	483
<b>92. A study of the transient processes on commutation of low voltage loads</b> I. Nedelchev, H. Zhivomirov, Y. Rangelov, N. Nikolaev, R. Vasilev .....	489
<b>93. Particle collection efficiency analysis of an electrostatic precipitator</b> L.S. Paraschiv, S. Paraschiv .....	495
<b>94. Modelling and control of a DC motor</b> C.A. Sima, G. C. Lăzăroiu, V. Dumbravă, M. Tîrșu, V. Galbură .....	499
<b>95. Construction log book – a web-based application that supports a building on its entire life-cycle</b> I. Udrea, V. Kraus .....	505
<b>96. Study of renewable energy resources by use of it applications</b> T. Vătuui, Gh. Lăzăroiu .....	511

# THE WASTEWATER TREATMENT USING OZONE TECHNOLOGIES

Aliyarov B. K<sup>1.</sup>, Bakhtaev Sh.A<sup>2.</sup>, Abdreshova S. B<sup>3.</sup>, Ongar B<sup>4.</sup>, Jesionek K.<sup>5</sup>

<sup>1</sup>Doctor of technical sciences, Professor, academician of National Academy of Science of RK, Almaty, Kazakhstan, [aliyarov\\_b@mail.ru](mailto:aliyarov_b@mail.ru)

<sup>2</sup>Doctor of technical science, professor Almaty, Kazakhstan

<sup>3</sup>Almaty University of Power Engineering and Telecommunication, Kazakhstan, 050012, Almaty, Baytursynov street, №126 [samalnur\\_777@mail.ru](mailto:samalnur_777@mail.ru), PhD, Student.

<sup>4</sup>Almaty University of Power Engineering and Telecommunication, Kazakhstan, 050012, Almaty, Baytursynov street, №126. [Ongar\\_Bulbul@mail.ru](mailto:Ongar_Bulbul@mail.ru), PhD, Student.

<sup>5</sup> Doctor of Sciences, Professor, Wrocław University of Science and Technology, Wybrzeże Wyspiańskiego 27, 50-370 Wrocław, Poland, [krzysztof.jesionek@pwr.edu.pl](mailto:krzysztof.jesionek@pwr.edu.pl)

## ABSTRACT

The issues of using ozone technologies for wastewater treatment are considered. The analysis of wastewater of complex composition from organic, chlororganic, organometallic compounds were carried out. The general scheme of water treatment is presented.

The developed ozone-flotation wastewater treatment technology and the switching power supply of ozonize is described, which allows increasing the specific ozone yield at lower power consumption.

**Keywords:** ecology, chlorination, toxicity, ozone technologies, disinfection, sewage, purification, ozone-air mixture, water treatment, flocculants, corona discharge, ozonization.

## 1. INTRODUCTION

Development of production activities in the energy sector, exploration of outer space, exploration and exploitation of large oil fields, creation of mining and processing and metallurgical industries, intensification of agricultural production and many others lead to an inevitable and significant deterioration of the ecological situation in the territory of the Republic of Kazakhstan.

The current state of affairs requires a new approach to epidemiological security and, in particular, stimulates work to improve the old, create and introduce new technologies for water purification and disinfection.

The real practical technologies that have been tested on existing large-scale water purification facilities are chlorination and ozonization.

One of the main reasons why the applicability of the traditional method of disinfection with chlorine is now being questioned is the formation of chlorine-organic compounds in water under the influence of chlorine.

Organochlorine compounds according to numerous studies in relation to humans have high toxicity, mutagenicity and carcinogenicity. Chlorination of wastewater before discharging into water bodies leads to the fact that chlorine derivatives and residual chlorine, falling into

natural water bodies, have a negative effect on various aquatic organisms, causing them to have serious physiological changes and even their death. In addition, organochlorine compounds are also pollutants of drinking water, because, having high resistance, cause pollution of rivers at considerable distances downstream, practically not being removed during the water treatment.

One of the most effective ways to solve the problem of disinfection of sewage with a complex composition is the use of environmentally friendly, non-reagent methods, such as ozonation, flotation, as well as the use of alternative types of impact on cleaned objects.

When disinfecting sewage, the use of combined and new electron-ion technologies is most effective, the use of corona discharge to produce ozone and water-air ejectors for the non-pressure introduction of the ozone-air mixture into the ozonized fluid flow.

The ability of many impurities in the aqueous medium to change its phase-dispersion state under the influence of physical and chemical factors (pH, salt composition, temperature, etc.) makes it possible to vary widely the methods and methods of regulating water treatment processes [1].

When disinfecting sewage, the use of combined and new electron-ion technologies is most effective, the use of corona discharge to produce ozone and water-air ejectors for the non-pressure introduction of the ozone-air mixture into the ozonized fluid flow.

The ability of many impurities in the aqueous medium to change its phase-dispersion state under the influence of physical and chemical factors (pH, salt composition, temperature, etc.) makes it possible to vary widely the methods and methods of regulating water treatment processes.

The basis of purification methods is oxidation, coagulation.

The purification technique consists in binding the ions to be eliminated in poorly soluble and slightly dissociated compounds by means of reagents, where the importance of the product of the solubility of the compounds formed is important.

When choosing the technological parameters of water treatment schemes, it is necessary to determine the main elements of treatment plants, taking into account the individual characteristics and composition of impurities of natural waters and industrial effluents [2].

An example is a reagent preparation unit and introducing them into the volume of the treated solution, in which the higher the mass transfer rate in the reagent-worked solution system, the lower the reagent consumption and the higher the quality of the resulting precipitate with the high rate of the phase separation process.

## **2. EXPERIMENTAL STUDY**

It is necessary to take into account the conditions of the course of chemical reactions, since in reaction spaces of small and large sizes, flowing and stationary systems, the processes can be quite different, and the simple increase in the magnitude of factors cannot be transferred from laboratory studies to industrial design. An example of the influence of the reaction space can serve as sedimentation processes of aggregated precipitation or optokinetic coagulation. Here, even in a stationary medium, the rate of precipitation of the slurry is a function of the thickness of the slurry layer in which the slurry precipitates. The influence of the diffusion factors of the turbulence of the flows, the conditions of heat removal on the speed and nature of the chemical and physical-chemical processes in the course of water treatment are currently poorly understood, despite their importance in the modeling of technical processes.

Figure 1 shows the general equipment scheme of water treatment.

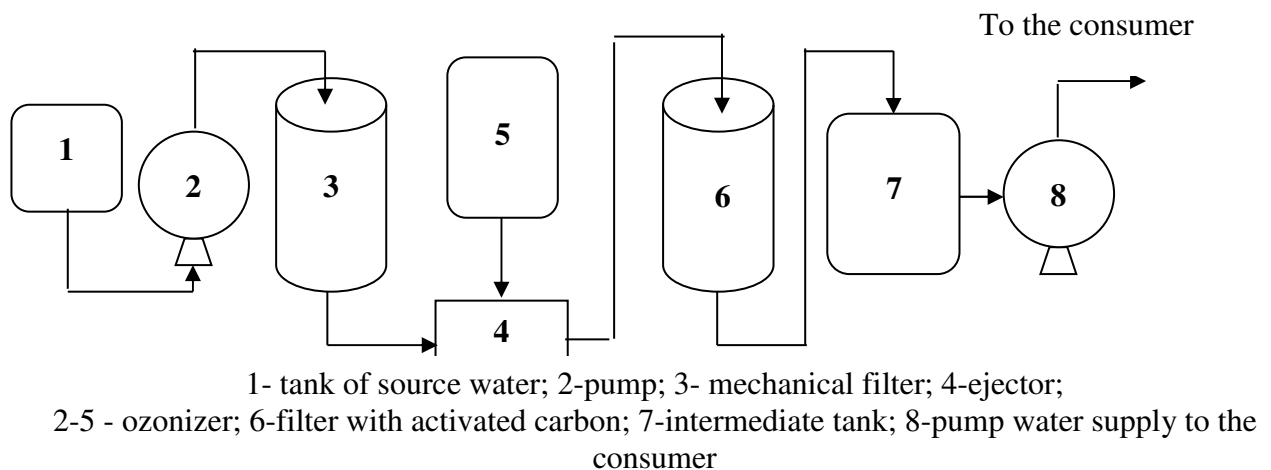

Fig. 1. Equipment diagram of water treatment

When analyzing the trends in the development of water treatment technologies, there is a clear tendency to create complex schemes based on several processes that ensure the removal of the entire amount of harmful impurities from water.

Figure 2 is a schematic diagram of the wastewater treatment technology to the required conditions using an ozone-air mixture [3].

### 3. RESULTS AND DISCUSIONS

When developing a technological scheme for processing waters of different composition, it is necessary to take into account the shortcomings inherent in each of the methods.

Complication of the surface water composition requires the abandonment of chlorine, as the main oxidant and disinfectant, especially in the agricultural regions and areas where the oil and gas production and chemical industries are located.

When interacting with organic substances (Figure 3), chlorine and ozone interact differently. The formation of organochlorine compounds, which are toxicogens, carcinogens and mutagens, already worsen the critical situation with drinking water.

The use of chlorination of sewage fecal waters leads to the formation of chloramine, which has a low antibacterial activity, but high resistance, killing and depressing the vital activity of the biological diversity of the water and near-water space. The effect of ozone and chlorine on the pathogenic microflora is different.



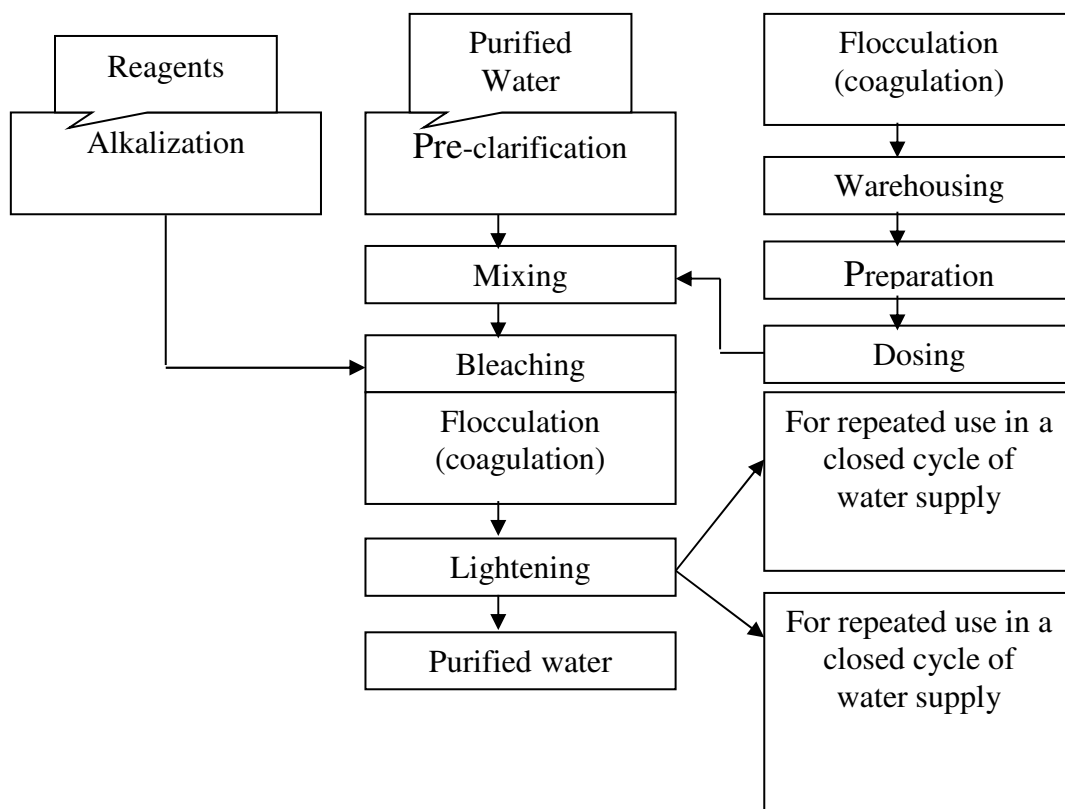
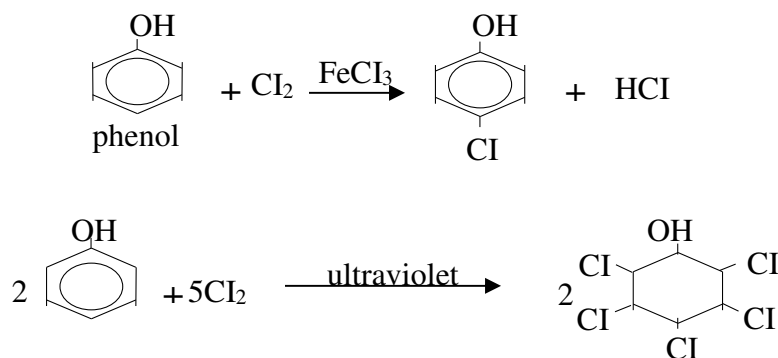

Fig. 2. Principal flow chart for wastewater treatment

It was found that the polio virus is killed by a dose of 0.4 mg / l of ozone after 2 minutes, while chlorine kills at a dose of 1 mg / l after 4 hours.

The disinfecting effect of ozone on pathogenic microorganisms is 15 to 20 times, and the spore forms of bacteria are approximately 300-600 times stronger than chlorine. On the effect of disinfection of water in ozonation, the pH and temperature practically do not indicate the influence, the chemical composition of the medium does not change ( $\varphi_{ox/red} = 2,01$ ,  $Cl_2 = 1,35$ ).

We have developed technological schemes for water purification by means of ozonation with ozonizers of the author's design that passed all the tests in the relevant organizations and entered into the register of the State Standard of the Republic of Kazakhstan [4].



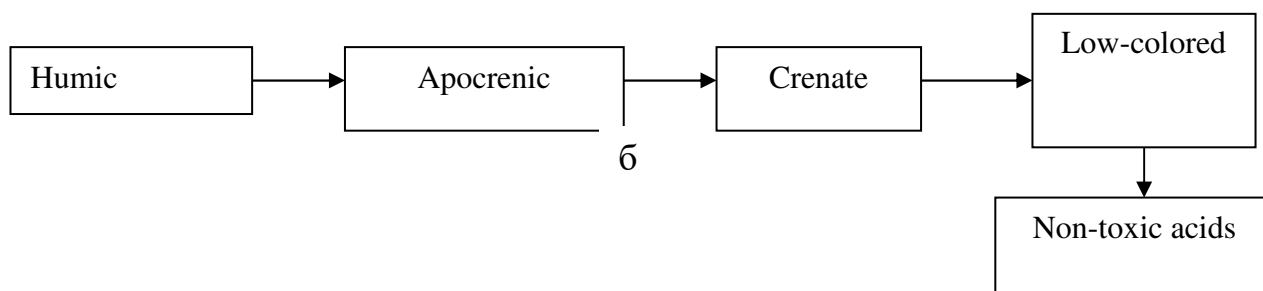
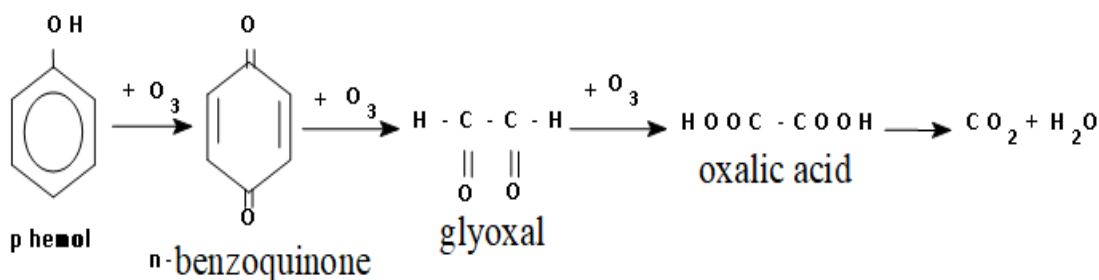

Fig. 3. Reactions of the interaction of chlorine and ozone with organic substances on the example of toxic phenol (a) and ozone with humic substances (b)

In sewage treatment technologies containing a significant amount of organic substances in the form of petroleum products, we have developed a purification technology using the rupture of the continuity (homogeneity) of the aquatic medium with ozone-air mixture bubbles [4, 5].

The essence of this method is that the ejector-dispersant, based on the use of the element of the "Schott filter" type, saturates the water with the smallest bubbles and makes the solution inhomogeneous, which is in a turbulent state. This causes cavitation phenomena, shock waves in the volume of the treated solution.

The sum of these impacts releases a significant amount of energy contained in substances in solution, far exceeding the exerted forces, leading to a synergistic effect [6-8].

This allows the ozone-air mixture to instantly penetrate into the entire volume of the solution, which increases the ozone's useful utilization rate to 95-100%.

#### 4. CONCLUSIONS

In practice, to purify natural and wastewater from mechanical and colloidal suspensions, aluminum or iron sulfates are used as coagulants. According to modern ideas, the process of coagulation is as follows: when they are added to the system during the first 30-180 sec, hydrolysis occurs, resulting in the appearance of large cations such as  $[Al(OH)_2]^+$ ,  $[Al(OH)]^{2+}$  or  $[Fe(OH)_2]^+$ ,  $[Fe(OH)]^{2+}$ , which have a large adsorption potential, and adsorbed on the surface of negatively charged particles reduce the charge and dispersion potential, and lead to coarsening of the particles.

To eliminate these drawbacks and more complete removal of mechanical and colloidal suspensions from drinking and waste water, flocculants are used together with coagulants.

Flocculants are substances of organic origin, which have a diphylic structure, i.e. contain simultaneously polar and non-polar groups and are readily soluble in water. Flocculants, depending on the application, are low-molecular, high-molecular, cationic, anionic, nonionic and amphoteric [9].

The principle of the flocculant is as follows: when a certain amount of it is added to the system, it can be adsorbed on the surface of the dispersions, forming so-called bridges between

adsorbed particles, and forming the ions consisting of several particles fixed by the macromolecules of the flocculant.

A new approach to managing the purification of various waters from fine particles, proposed by us, consists in using associates of water-soluble polymers with low and high-molecular compounds [10]. In this case, the association of ions of surface active substances with polyelectrolyte occurs not only on the surface of colloidal particles, but also in the regions of macromolecules located between the aggregated particles of the disperse phase in the form of bridges.

## REFERENCES

1. Getmantsev S.V., Ecology of wastewater treatment by physical and chemical methods. - M.: Publishing house of the Association of Construction Universities. - 2009, 186 p.
2. Laptev A.G., Water treatment and water purification in power engineering / AG Laptev, ES Sergeeva // Water: chemistry and ecology. - 2011, No. 3.- pp.33-40.
3. Bakhtaev Sh.A., Almagambetov B.N., Abdreshova S.B. Development of electron technology for wastewater treatment // The 7th Anniversary International Scientific and Technical Conference "Energy, Telecommunications and Higher Education in Modern Conditions". - Almaty: AUPET, 2010. (in russian)
4. Bakhtaev Sh.A., Abdreshova S.B. Complex cleaning and disinfection of sewage and oily waters with the use of ozone. Bulletin of AUES. - Almaty: AUCP. - 2013, No. 4 (23). - pp. 39-45
5. Bakhtaev Sh.A., Bokanova A.A., Ermagambetov S.B., Baymakhanova Z.A., Myrzabekova A.M., Abdreshova S.B. A method for controlling gas bubbles in a liquid // Preprint RK, No. 14716, Byull. № 8, August 16, 2004.
6. Bakhtaev Sh.A., Abdreshova S.B., Application of ozone technology for wastewater treatment // Materials of the International Scientific and Practical Conference "Creativity of young scientists of the XXI century". - Petropavlovsk: SKGU, 2003. (in russian)
7. Bakhtaev Sh.A., Baymakhanova Z.A., Abdreshova S.B., Ozone purification and disinfection of aquatic environments // Proceedings of the scientific conference "Science and education is the leading factor of the" Kazakhstan-2030 "strategy. - Karaganda: KSTU, 2008. - P.192-194. (in russian)
8. Bakhtaev Sh.A., Almagambetov B.N., Abdreshova S.B., Ozone purification and disinfection of drinking and waste water // Journal of Ecology - Almaty: KazGU after named Al Farabi, 2010. (in russian)
9. Bakhtaev Sh.A., Almagambetov B.N., Abdreshova S.B., Application of electron technology for wastewater treatment // The Bulletin of AUPET - Almaty: AUPET, 2010. (in russian)
10. Jesionek K. J., Wpływ natleniania wody kotłowej na stan powierzchni elementów zaworu regulacyjnego, (Effects of boiler feedwater oxygenation on the elements surface of a steam turbine control valve), Inżynieria Chemiczna i Procesowa, Tom 27, Zeszyt 3/2, Wrocław 2006, pp. 1229-1240. (in Polish)

# COMPARATIVE ANALYSIS OF POSSIBLE SOLUTIONS OF USING HEAT RECOVERED FROM UPB-CHP PLANT

Diana BAN (TUȚICĂ)<sup>1</sup>, Paula TUDOR<sup>2</sup>, Eduard MINCIUC<sup>1</sup>, Victor-Eduard CENUȘĂ<sup>1</sup>,

<sup>1</sup>University Politehnica of Bucharest, Power Engineering Faculty

<sup>2</sup>University Politehnica of Bucharest, Entrepreneurship, Business Engineering and Management Faculty

## ABSTRACT

The efficient use of cogeneration energy systems in Romania depends on the heat demand variations and on the restrictions imposed by the related legislation. The paper presents a comparison between two different solutions for the useful use of the recovered heat losses of a combined heat and power plant, during the summer periods. The authors have performed a technical-economic analysis of implementation of a trigeneration system dedicated to supply: a) a part of an University Campus and b) a group of new buildings built near the plant. The results obtained from the calculation revealed that for this specific case, the best solution to increase the power plant performances, is to generate, from the recovered heat, cold water and to use it for space air conditioning in the residential buildings.

## 1. INTRODUCTION

The important role of cogeneration has been recognized at the European Union level through dedicated Directives that support and promote the use of combined heat and power (CHP) technologies in all sectors [1], [2]. At the present, cogeneration represents one of the most efficient solution for rational utilization of fuel, its use leading to reduction of fossil fuels consumption and diminution of greenhouse gases emissions [3]. A very important problem that cogeneration facilities face is that many energy consumers have large variations in energy consumption [4]. In Romania, CHP benefits of a support scheme that foresees an amount of money (Bonus in €/MWh) for each unit of produced and sold electricity. To receive this subsidy, a producer must cumulatively meet several mandatory conditions: a) the sizing of the CHP is made so that the heat recovered from the power generating equipment ensures the coverage of a useful heat load; b) the plant has to realise a fuel saving of at least 10%, in comparison to the separate production and c) the overall efficiency must be greater than 75% [1], [5]. If the three conditions are not met, there will be no bonus and therefore economic operation of the plant will be seriously affected.

In this paper the authors analyzed the possibility to increasing the efficiency of a CHP plant through a better utilization of available heat during summer time for cooling supply of two possible existing consumers: the University it self or the new residential neighborhood.

## 2. CASE STUDY

The analyzed facility refers to a Combined Heat and Power Plant built to supply with power and heat the University's Politehnica of Bucharest Campus. The University's cogeneration power plant is equipped with two reciprocating engines using natural gas. Together, the two engines generate 1.6 MW<sub>e</sub> of electricity. The power which exceeds the University's own consumption is sold on electricity market.

---

<sup>1</sup>Splaiul Independenței 313, Bucharest, Romania, 0723411052, dianatutica@gmail.com

During the winter time, heat recovered from the two engines, about 2 MW, is used within the district heating network of the University's campus. The first stage of heat recovery is from flue gases through heat exchangers (523 kW from each). The second stage of heat recovery is from cooling circuits through several heat exchangers, leading to 444 kW of recovered heat from each engine. The main heat exchangers from the engine cooling network and the main temperature levels with the corresponding recovered energy are illustrated in figure 1.

Being a University, in summer the demand for heat is almost zero, and even if the reciprocating engines can be used at full load, the available heat has to be exhausted into the atmosphere. In this situation, the overall efficiency will drop dramatically. So the main objective that the authors tried to achieve in this work, was to determine a useful and efficient way to use the engines heat losses during summer. Due to the climate and to the possible consumers characteristics, the most appropriate solution was to produce cooling water for air climatisation, through absorption chillers.

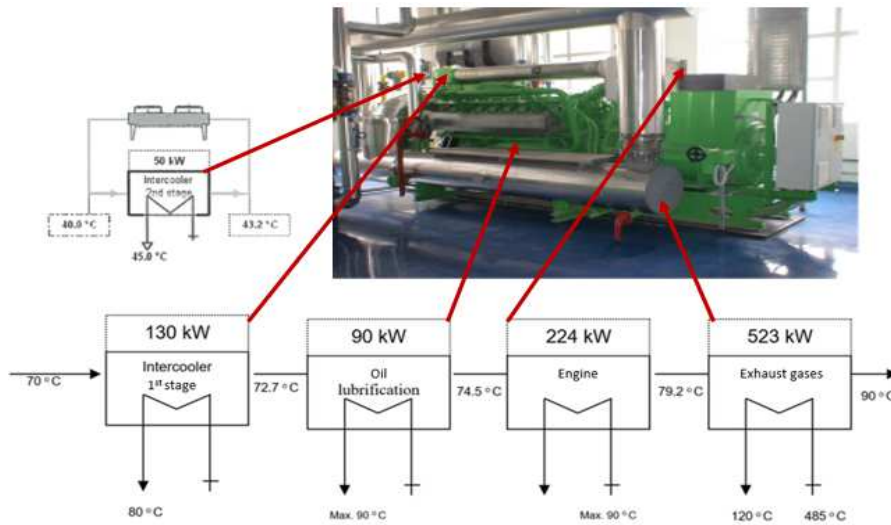

Figure 1: Main heat recovery elements of the reciprocating engine [6]

### 3. TECHNICAL AND ECONOMIC ANALYZES

Taking into account that the temperature level for the working fluid that can be used for absorption chillers is warm water at under 90 °C, the appropriate chiller that can be used is BrLi absorption chiller in one stage. In this case, the coefficient of performance (COP) of absorption chillers using warm water with temperature under 90 °C is about 0.5 [7]. This leads to a production of approximately 1 MW of cold water, using the 2 MW<sub>th</sub> of heat. There were chosen 2 absorption chillers, of 0.55 MW each, having one absorption stage, specially designed for cold water production with temperatures 7/12 °C using available heat from industrial processes or cogeneration units [4].

There have been taken into consideration two kinds of possible consumers for the cold water production: a) a part of an University Campus (offices and research laboratories) and b) a group of new buildings built near the CHP plant. For both consumers demands, we used a simple standardized method for the common facilities, based on predefined cooling load coefficients and on the surface of the analyzed room calculated with the formula (1) [8].

$$Q_c = S \cdot C_c \quad [W] \quad (1)$$

where:  $Q_c$ - is the cooling load, in [W];  $S$ - is the useful area of the analyzed space, in [m<sup>2</sup>] and  $C_c$ - is the standardized coefficient [W/m<sup>2</sup>].

The standardized coefficient (cold demand) has been estimated at 70 W/m<sup>2</sup> for case b) and at 90 W/m<sup>2</sup> for the offices and 110 W/m<sup>2</sup> for the laboratories and class rooms in case a). Number and average area that lead to the total cooling demand (Q<sub>c</sub>) are centralized in table 1.

Table 1: Average cold demand for both analyzed cases

a) University Campus			b) Residential buildings		
Type of space	No of app.	S [m <sup>2</sup> ]	Type of space	No of app.	S [m <sup>2</sup> ]
Class rooms	11	193	Studio	110	35
Research laboratories	90	30	2 rooms apartments	75	60
Offices	160	20	3 rooms apartments	55	100
Cold demand [MW]		0.96	Cold demand [MW]		0.97

Investment in the new components of the cooling absorption system is explained in table 2. The main equipments are the same in both analyzed cases (chilling machines, heat exchangers, pumps etc.). The difference comes from the fact that for the University's Campus we don't need new cooling pipes (heating and cooling are never supplied at the same time), but we need inside ventilation units. Meanwhile, for the case of residential buildings, we have to instal new insulated pipes of 219 mm x 5.00 mm, with a total cost of 55000 Euros and cold water supply pumps for district cooling, totalizing 16500 Euros.

Table 2: Investment cost for chillers and auxiliary equipment necessary for both cases

Equipment	Quantity (Units)	Price (€/ unit)	Total price (€)
Absorption chiller BrLi, 0.55 MW	2	100150	200300
Heat exchanger primary fluid 90/70 °C, secondary fluid 87/63.7 °C, 951 kW	2	3500	7000
Chiller warm water supply pump, 600 l/min, 10 m	2	6100	12200
Cold water pump 35.2 l/s, 40 m,	2	12500	25000
Cooling tower in closed– 892 kW	1	35000	35000
Cold water insulated storage tank	2	4100	8200
Pumps' automation equipment	1	3000	3000
Total costs of equipments			313400
Expansion tanks, buffer tank, valves, manometers, thermometers, filters, (5% from equipment value) and installation (5% from equipment value) [5]			31340
Total including installation			344740
Other expenses (4% from total)			13790
Total value of the absorption chillers equipment (Euro)			358530

Another difference regarding the investment is generated by the need to instal new fun coils in all climatized units from the Campus. For each room we chose machines with refrigerant loads between 2 and 3.5 kW, the total investment value beeing of 150000 Euros (installation included).

For case a) the average functioning period is obaout 500 h/year and the new fun coils will replace old air conditioning equipments (being energy class B, the energy efficiency ratio is 2.7), and will lead to a consumption economy of 450 kW of electricity. The annual energy saving by implementing the new system, will be of 225 MWh (the net saving after internal consumption is 189 MWh). By selling on the energy market this amount of electricity, the University's CHP Plant will earn 35910 Euros/year.

For the case b) total yearly operation period is of 1200 h/year at nominal capacity. This means that for a price of 35 €/MWh of cooling, the total sold cooling capacity (1164 MWh/year) will generate an income of 40.740 Euros/year (economic analysis in figure 2).

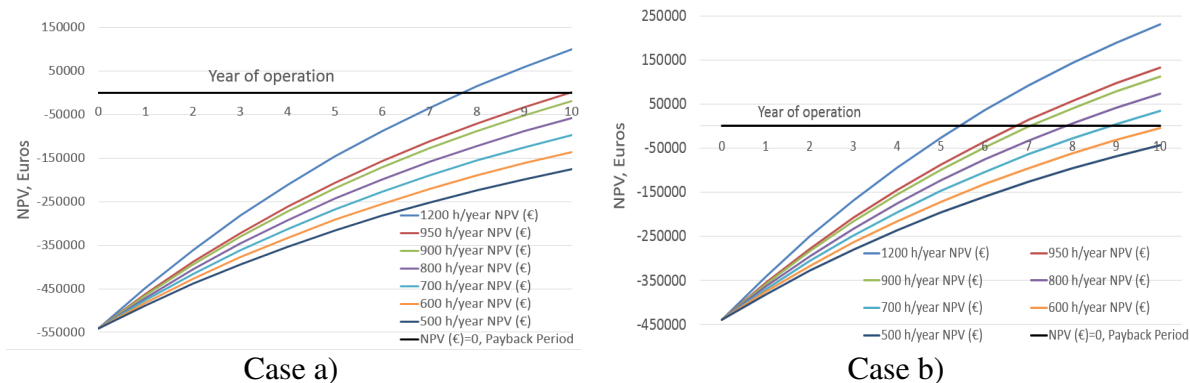

Figure 2: Economic analysis of the proposed solutions for a 10-year period

#### 4. CONCLUSIONS

In the paper there were presented several possible options of using thermal potential of the tow reciprocating engines of UPB CHP, to generate cooling water, in order to supply a potential consumer. According to the calculations both solutions are technically efficient, however the first case (UPB Campus) has some special characteristics being an University. The most important is the fact that the cooling is needed only 500 hours per year.

To better understand which solution is more cost-effective, an economic analysis based on the Net Present Value (NPV) was realized for an operating period of 10 years. From figure 2, we can observe that in the case a) for a cooling period of 500 hours, the investment can't be recovered during the life time period of the equipments. From the sensitivity analysis, the minimum number of working hours should be 950, in order to reach, before the last year (10), the value 0 for de NPV. Meanwhile for case b), the payback period is between 5 and 6 years.

In other words, if the consumption of UPB does not increase in the next period, the only viable solution remains the one analyzed in case b).

#### Acknowledgements

This work has been funded by University Politehnica of Bucharest, through the "Excellence Research Grants" Program, UPB – GEX 2017. Identifier: UPB- GEX2017, Ctr. No. 139 /2017 (PERFOCET)".

#### References

- [1] \*\*\* Romanian Energy Regulatory Authority, Energy Efficiency Department, Energy: *Efficiency Trends and Policies in ROMANIA*. 2015 Bucharest.
- [2] El-Khattam W., Bhattacharya K., Hegazy Y., and Salama M. M. A., *Optimal investment planning for distributed generation in a competitive electricity market*, IEEE Trans. Power Syst., pp. 1674–1684, Aug. 2004
- [3] Siddiqui A. S., Marnay C., Bailey O., and LaCommare K. H., *Optimal selection of on-site power generation with combined heat and power applications*, Int. J. Distrib. Energy Res., vol. 1, no. 1, pp. 33–62, Jan.–Mar. 2005.
- [4] D. Tutica, P. Tudor, R. Patrascu, E. Minciuc, G. Darie, *Energy saving and environmental protection by integrating cogeneration in new residential buildings*, SGEM2017 Vienna GREEN Conference Proceedings, ISBN 978-619-7408-29-4 / ISSN 1314-2704, 2017, 527-534 pp; DOI: 10.5593/sgem2017H/63/S26.067
- [5] Athanasovici, V. et al., *Treaty of thermal engineering. Heat supply. Cogeneration (Tratat de inginerie termică. Alimentaři cu căldură. Cogenerare)*, AGIR, Bucharest, 2010.
- [6] \*\*\*, *Technical instructions of GE Jenbacher, Cogeneration Unit JMS 316 GS-N.LC*, CEE/06472/05/O1, 2007
- [7] Georgiana T.-D., *Exergetic and economic optimization of trigeneration systems*, PhD Thesis, 2012.
- [8] Iliina, M. et al., *Installation manual, Warming systems (Manualul de instalații, Instalații de încălzire)*, Vol. 1, ARTECNO, Bucharest, 2002.

# COMPARATIVE ANALYSIS OF TWO SOLAR DRIVEN CYCLES UNDER CLEAR AND CLOUDY SKY CONDITIONS

Bogdan Borcila<sup>1a</sup>, Camelia Stanciu<sup>a</sup>, Monica Costea<sup>a</sup>, Stoian Petrescu<sup>a</sup>, Michel Feidt<sup>b</sup>

<sup>a</sup>University POLITEHNICA of Bucharest, Bucharest, Romania

<sup>b</sup>Lorraine University, Nancy, France

## ABSTRACT

The paper presents a comparative analysis of two solar powered systems aiming to produce electricity. The potential user could be a duplex house or an office building. One system consists of an Organic Rankine Cycle (ORC) modeled to operate at variable mass flow rate, constraint by the heat source temperature which is provided by a parabolic dish collector. The second one is a Stirling engine modeled by taking into account the internal and external irreversibilities, using the concentrated solar radiation from dish collector, too. Both engines have to deliver the same electrical power (constraint), according to the user's daily energy consumption profile. The study considers the daily solar radiation and ambient temperature variation under cloudy sky conditions, and the receiver heat losses dependence on these data. The analysis results emphasize the required solar collector dimensions in each case. The comparison is done to previous obtained results under clear sky conditions.

## 1. INTRODUCTION

In the recent past, the solar energy has proven to be an actual alternative and clean source of energy for the sustainable development of the society worldwide. It is cheap, abundant and everlasting as source of renewable energy and thus it can be integrated in different systems to overcome the dependency of present society on conventional fuels [1-2].

Such integration of solar energy has given an opportunity for several studies based on the energy and economic approaches of solar-powered Stirling engine system. Ferreira et al [3] developed a methodology for the thermal-economic optimization of micro cogeneration units, showing its great potential for applications in the residential sector, with a payback period of approximately 10 years. As a performant solar radiation concentrator, the parabolic dish coupled with a Stirling engine was modelled and its operation was simulated for insolation conditions in Egypt [4] or in Brazil [5]. Both studies aimed to find the best performance in terms of energy production and efficiency, and developed sensitivity analysis for the receiver working fluid [4], or for collector diameter, wind speed and tilt angle of the cavity [5].

Among the under development micro-scale power generation technologies the ORC concept is a promising solution for smaller units for domestic users [6-8]. The operation of a solar power plant associated with a latent heat thermal storage and an ORC unit was simulated under dynamic (time-varying) solar radiation conditions [9] showing that the system is able to provide power in 78.5% of the time, with practical efficiency for the ORC unit. The working fluid for ORC system is important to improve efficiency and achieve better economy [10].

In this paper, a comparative analysis of two solar powered systems performance for residential consumers, one with Stirling engine, and the other with Organic Rankine Cycle is done. The aim of the analysis is to provide information that could help the consumer to choose the system that best suits his needs taking into account the two extrema for sky conditions – cloudy and clear ones.

---

<sup>1</sup>Department of Engineering Thermodynamics, +40-21-4029339, bbd1188@yahoo.com



## 2. DESCRIPTION OF THE TWO SOLAR DRIVEN SYSTEMS

**The Stirling system** consists of a Dish-Receiver assembly that will provide the necessary heat input, a Stirling engine and an electrical generator, as shown in Fig. 1. The power output of the electrical generator can be used directly by the consumer and the surplus is stored in a battery, to be supplied for covering the pick consume or the periods without sun.

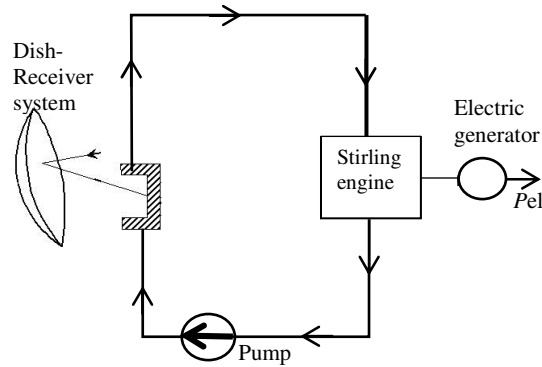

Figure 1: The Stirling system

Experimental data obtained from the V-160 *Stirling engine* [11] are used for the Stirling engine modeling.

**The Organic Rankine Cycle system** is also driven by the assembly of a Dish Receiver and coupled to a storage tank (ST), which will ensure a stable operation. The fluid is circulated through the receiver of the dish solar collector and heated along the day, simultaneously feeding the evaporator of the organic Rankine cycle, as presented in Fig. 2.

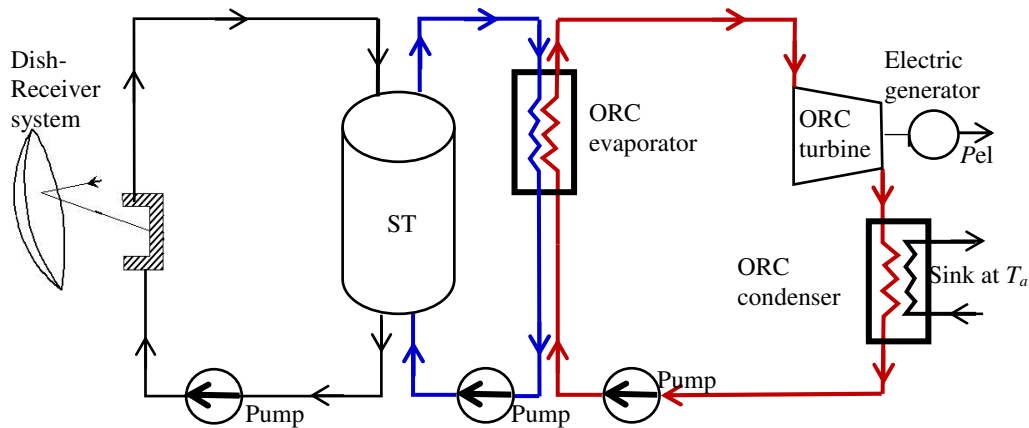

Figure 2: The Organic Rankine Cycle system

Therminol XP is chosen as heat transfer fluid in the solar receiver tubes, with a mass flow rate of 0.7 kg/s. The storage tank module is a fully mixed one, assuring a uniform temperature in its bulk volume, having a capacity of 100 kg.

The parabolic dish collector feeds the storage tank ST, to which the evaporator of the Organic Rankine Cycle (ORC) is coupled ensuring the heat exchange between the organic fluid (n-pentane in this case) and the ST fluid. A lower limit is set for ORC operation at 80°C in order to avoid instability and poor operation. The ORC operates between ambient condensation temperature and a vaporization level imposed by the ST fluid temperature, higher than the lower set limit and lower than the optimum vaporization temperature for maximum power output, 140°C [12]. The main target of this study is to compare the results

obtained with this technic arrangement under cloudy sky conditions, to previous results obtained under clear sky conditions [13].

### 3. MODELLING OF THE TWO SYSTEMS

#### Stirling engine performance evaluation based on the Direct Method from TFS

In the frame of Thermodynamics with Finite Speed and using the Direct Method ,the Stirling engine efficiency will be given by the equation [14]:

$$\eta_{SE} = \eta_{CC} \cdot \eta_{II,irrev} = \underbrace{\left(1 - \frac{T_L}{T_{H,S}}\right)}_{\eta_{CC}} \cdot \underbrace{\left[1 + \sqrt{\frac{T_L}{T_{H,S}}}\right]^{-1}}_{\eta_{II,irrev,\Delta T_{opt,power}}} \underbrace{\left[1 + \frac{X \left(1 - \sqrt{T_L / T_{H,S}}\right)}{(\gamma - 1) \ln \varepsilon}\right]^{-1}}_{\eta_{II,irrev,X}} \eta_{II,irrev,\Sigma \Delta P_i}, \quad (1)$$

- where: -  $\eta_{II,irrev}$  – the second law efficiency cumulating the cycle irreversibility effect;  
-  $T_{H,S}$  – the receiver temperature (hot source);  
-  $T_L$  – the cold end temperature;  
-  $\Delta T_{opt,power}$  – the optimum temperature difference at the source for maximum power delivered by the Stirling engine;  
-  $\eta_{II,irrev,X}$  – the second law efficiency due to incomplete regeneration of heat;  
-  $\gamma$  – the specific heat ratio ( $= c_p/c_v$ );  
-  $\varepsilon$  – the volumetric ratio,  $\varepsilon = V_{max}/V_{min}$ ;  
-  $\eta_{II,irrev,\Delta P}$  – the second law efficiency due to pressure losses, expressed as [14, 15]:

$$\eta_{II,irrev,\Sigma \Delta P_i} = 1 - \frac{\frac{w}{w_{SL}} \gamma (1 + \sqrt{\tau}) \ln \varepsilon + 5 \cdot N_S \left(\frac{w_{gR}}{w_{SL}}\right)^2 + \frac{3(0.94 + 0.045w)}{4P_1} 10^5}{\tau \cdot \eta \cdot \ln \varepsilon} \quad (2)$$

with:

$$\eta' = \left(1 - \sqrt{\frac{T_L}{T_{H,S}}}\right) \cdot \left[1 + \frac{X \left(1 - \sqrt{T_L / T_{H,S}}\right)}{(\gamma - 1) \ln \varepsilon}\right]^{-1} \quad (3)$$

and  $w$  – the average speed of the piston;  $w_{SL}$  – the speed of the sound corresponding to the sink parameters;  $\tau$  – the ratio of the gas extreme temperature in the cycle ( $T_{max}/T_{min}$ );  $N_S$  – number of screens of the regenerator

Equation (1) emphasizes the main causes of irreversibility in actual Stirling Machines that decrease the ideal cycle efficiency (equal with the Carnot cycle efficiency), namely heat transfer at finite  $\Delta T$  at the hot end, incomplete heat regeneration in the Regenerator evaluated by the losses coefficient  $X$  [14, 15] that contains one of the adjustment coefficient of the model, and pressure losses due to friction.

Finally, the analytical expression for the power output results as:

$$Power_{SE,irrev} = \eta_{SE} \cdot z \cdot mRT_{H,g} \cdot \frac{w}{2z} \ln \varepsilon, \quad (4)$$

where the second adjustment coefficient,  $z$ , accounts for the finite heat rate at the source. Its value is equal to 0.55 or 0.8 [15].

#### ORC system performance evaluation

For the ORC system, the storage tank is a fully mixed one, characterized by a constant heat loss coefficient ( $U_{ST} = 0.7 \text{ W}/(\text{m}^2\text{K})$ ) [16]. The mathematical expression of the First Law of Thermodynamics allows us to compute the storage tank temperature at the next time-step ( $n + 1$ ) based on the value from the previous time-step ( $n$ ):

$$T_{ST}^{(n+1)} = T_{ST}^{(n)} + \frac{[\dot{Q}_u^{(n)} - \dot{Q}_{ev,ORC}^{(n)} - (UA)_{ST}(T_{ST}^{(n)} - T_a^{(n)})]\Delta\tau}{(mc_p)_{ST}}, \quad (5)$$

The time-step  $\Delta\tau = 10$  min for the simulations along a day or more consecutive days.

The term  $\dot{Q}_u^{(n)}$  is the useful heat rate absorbed by the receiver fluid, while  $\dot{Q}_{ev,ORC}^{(n)}$  represents the heat rate transferred to the organic fluid in the organic Rankine cycle evaporator. At system start-up, the initial storage tank temperature  $T_{ST}^{(0)}$  is set to ambient one  $T_a^{(0)}$ , while the ORC is turned off, so that  $\dot{Q}_{ev,ORC}^{(0)} = 0$ . For each simulation day, the computation is implemented for 24 hours starting from midnight.

**The sky conditions** are determined based on Meteonorm database [17], as 10-years-averaged measured values, for Bucharest, thus including cloudy days radiation and ambient temperature.

#### 4. RESULTS

The results are presented for two consecutive days, July 15<sup>th</sup> and 16<sup>th</sup> (the 196<sup>th</sup> and 197<sup>th</sup> days respectively out of 365 yearly days). The solar assembly is composed by the parabolic dish and the associate receiver of 18 cm diameter aperture, the same for both systems. Heat losses from the receiver to the surroundings, due to convection and radiation are considered. Different values of the dish diameter were considered, namely 8m, 12m, and 16m, in order to evaluate the most economical solution that suits to the consumer needs.

The Stirling engine system daily power output together with the consumption profile of the user are illustrated in Fig. 3. One can see that the 16 m dish largely covers the pick consumption of 2 kW, thus 12 m diameter would be a better choice, due to the battery use.

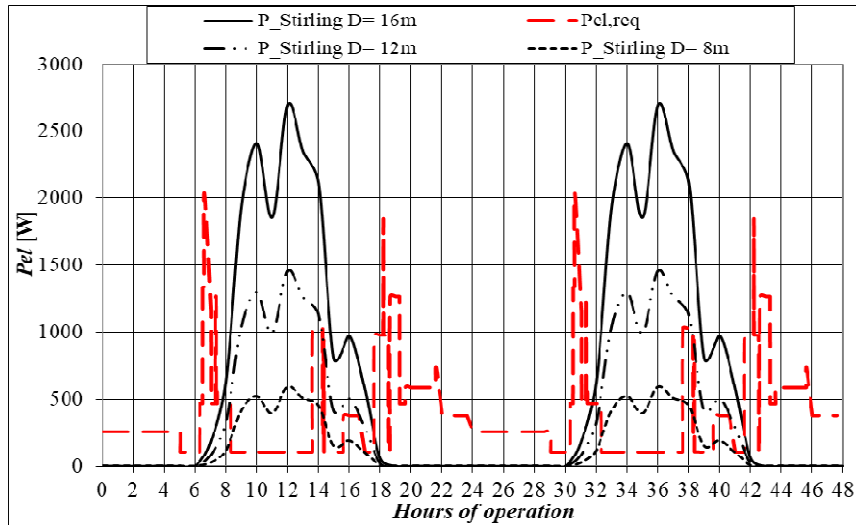

Figure 3: Stirling system power output with respect to the required one

Regarding the ORC system, the clear sky conditions revealed [13] that a dish diameter of 6m was sufficient to cover daily electric energy need of 8kWh. In the present study, authors have found that, under the same system characteristics, at least 18m diameter should be used (Fig. 4). Cloudy sky conditions imposed much lower solar radiation values and consequently the ST fluid heated insufficiently to run the ORC at desired rate.

Due to obviously technical difficulties in using such very large diameter dish, authors decided to modify some operating parameters in order to find a suitable solution. In this regards, the simulations were redone for a mass flow rate of fluid circulating the receiver reduced to 0.3kg/s and a period of two days charging the ST before ORC start-up. In this two-

days period, the ST fluid was heated, so that the ORC starts at an upper temperature level and having a previously stored thermal energy.

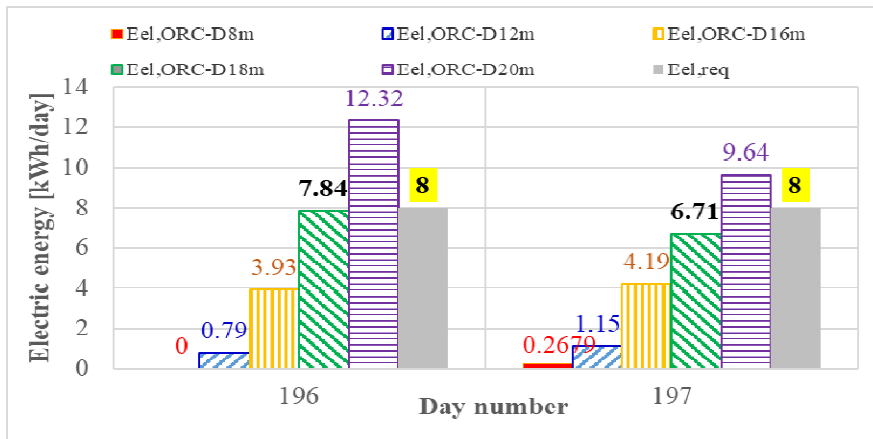

Figure 4: ORC daily electric energy produced under cloudy sky (and same parameters used for clear sky simulation in paper [13])

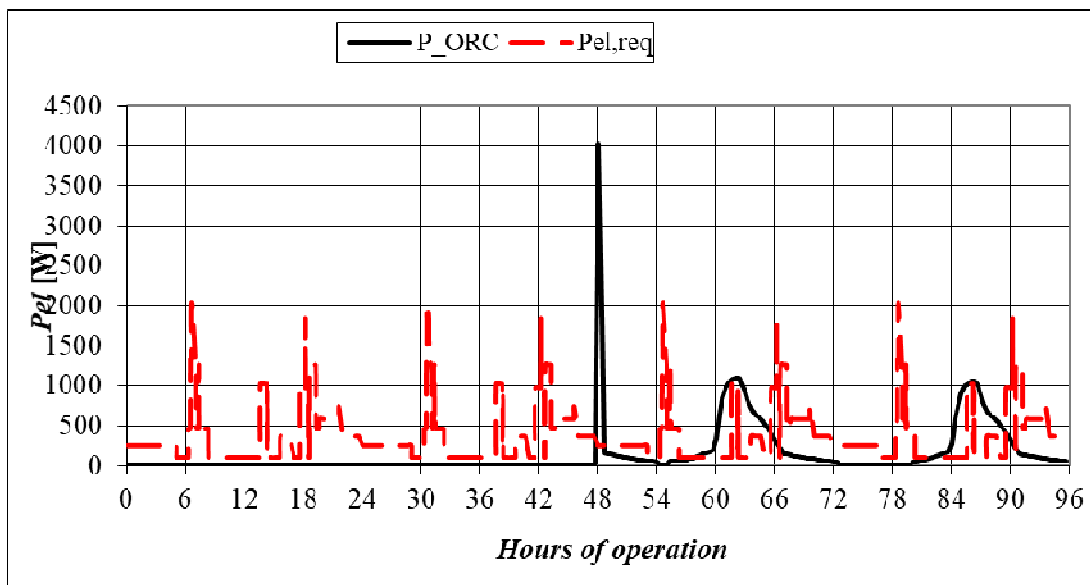

Figure 5: ORC daily electric energy produced under cloudy sky for a reduced value of receiver fluid mass flow rate (0.3kg/s) and two charging days before ORC start; 12m diameter dish

The simulation was performed for different dish diameters and the most suitable results were obtained for a dish diameter of 12m. Results are presented in Fig. 5. The ST fluid temperature attain 320°C after 40 hours of operation. ORC module was started in the third day and produced 8.3 kWh electric energy in 24 hours. The next days, the ORC module produced 5.56 kWh daily and the ST fluid temperature did not drop under 96°C, thus a stable operation condition was met.

## 5. CONCLUSIONS

Performance of Stirling engine and Organic Rankine Cycle systems, in terms of electric power, electrical energy provided by several dish diameter systems have been simulated, namely 8m, 12m, 16m for Stirling, completed by 18m and 20m for ORC respectively.

The results have been compared to previously obtained ones under clear sky conditions [13] and emphasized that the electric energy supply which is the closest to demand is provided by a system with a much larger dish diameter for the same system parameters, in the simulated case under cloudy sky. The ORC module requires a 18m dish diameter, compared to 6m one, while the Stirling engine, a 12 m diameter parabolic dish, compared to 5m one.

Modifying operating parameters, the ORC module required a 12m diameter dish for covering daily electric energy need and a two-days charging period of the ST before start. Further development of the analysis for different values of other operating and technical parameters and sink temperature levels (so that heat rejected could be used in cogeneration) is in due course.

## References

- [1] Taylor, J.A., Dhople, S.V., Callaway, D.S., "Power systems without fuel", *Renewable and Sustainable Energy Reviews*, 57, 1322-1336, 2016.
- [2] Kaldehi, B.J., Keshavarz, A., Pirooz, A.A.S., Batooei, A., Ebrahimi, M., "Designing a micro Stirling engine for cleaner production of combined cooling heating and power in residential sector of different climates", *Journal of Cleaner Production*, 154, 502-516, 2017.
- [3] Ferreira, A.C., Nunes, M.L., Teixeira, J.C.F., Martins, L.A.B.S., Teixeira, S.F.C.F., "Thermodynamic and economic optimization of a solar-powered Stirling engine for micro-cogeneration purposes", *Energy*, 111, 1-17, 2016.
- [4] Hafez, A.Z., Soliman, A., El-Metwally, K.A., Ismail, I.M., "Solar Parabolic dish Stirling engine system design, simulation, and thermal analysis", *Energy Conversion and Management*, 126, 60-75, 2016.
- [5] Caballero, G.E.C., Mendoza, L.S., Martinez, A.M., Silva, E.E., Almazan del Olmo, O., "Optimization of a Dish Stirling system working with DIR-type receiver using multi-objective techniques", *Applied Energy*, 201, 271-286, 2017.
- [6] Cioccolanti, L., Tascioni, R., Arteconi, A., "Simulation analysis of an innovative micro-solar 2kWe Organic Rankine Cycle plant for residential applications", *Energy Procedia*, 142, 1629-1634, 2017.
- [7] Taccani, R., Besong Obi, J., De Lucia, M., Micheli, D., Toniato, G., "Development and Experimental Characterization of a Small Scale Solar Powered Organic Rankine Cycle (ORC)", *Energy Procedia*, 101, 504-511, 2016;
- [8] Freeman, J., Guarracino, I., Kalogirou, S.A., Markides, C.N., "A small-scale solar organic Rankine cycle combined heat and power system with integrated thermal energy storage", *Applied Thermal Engineering*, 127, 1543-1554, 2017.
- [9] Manfrida, G., Secchi, R., Stanczyk, K., "Modelling and simulation of phase change material latent heat storages applied to a solar-powered Organic Rankine Cycle", *Applied Energy*, 179, 378-388, 2016.
- [10] Kumar, A., Shukla, S.K., "Analysis and performance of ORC based solar thermal power plant using benzene as a working fluid", *Procedia Technology*, 23, 454-463, 2016.
- [11] Stine, W.B., Diver, R.B., "A Compendium of Solar Dish / Stirling Technology", California, USA, Sandia Laboratories Report, SAND93-7026 UC-236, January 1994.
- [12] Stanciu, C., Stanciu, D., Tănase, B., Gheorghian, A., Dobre, C., "Storage Tank Mass Control for Optimum Solar-Powered Absorption Cooling System Operation", In: Proceedings of 2017 International Conference on Energy and Environment CIEM 2017, Bucurest, Romania, IEEE Catalog Number: CFP17L60-ART:363-367.
- [13] Borcila, B., Stanciu, C., Costea, M., Feidt, M., Petrescu, S., "Comparative Analysis of Constraint Operation of Solar Stirling and ORC Cycles", Proceedings of ECOS'18 Conference, Guimares, Portugal, 2018.
- [14] Petrescu, S., Costea, M., Harman, C., Florea, T., "Application of the Direct Method to Irreversible Stirling Cycles with Finite Speed", *International Journal of Energy Research*, 26(7), 589-609, 2002.
- [15] Petrescu, S., Costea, M., "Development of Thermodynamics with Finite Speed and Direct Method", AGIR Publishing House, Bucharest, 2011.
- [16] Tzivanidis, C., Bellos, E., Antonopoulos, K.A., "Energetic and financial investigation of a stand-alone solar-thermal Organic Rankine Cycle power plant", *Energy Conversion and Management*, 126, 421-433, 2016.
- [17] Meteororm: Irradiation data for every place on Earth, [www.meteororm.com](http://www.meteororm.com).

# THE USE OF RAW ANIMAL FATS-BUTANOL-DIESEL FUEL BLENDS AT DIESEL ENGINE

Cernat Alexandru<sup>1</sup>, Pana Constantin, Lazaroiu Gheorghe,  
Negurescu Nicolae, Nutu Cristian, Nicolici Adrian  
University Politehnica of Bucharest

## ABSTRACT

The use of the alternative fuels, even in partial substitution, may represent a viable solution to reduce the diesel engine pollutant emissions and to maintain the diesel engines in service and in urban traffic. The animal fats-butanol-diesel fuel blends are an alternative fuel which can be used at diesel engines, in order to reduce the pollutant emissions. The main advantages of animal fats- diesel fuel blends like cetane number and calorific value very close to diesel, higher oxygen content it recommend it as a good alternative fuel for diesel engines, being renewable and energy efficient. The results of experimental investigations show the animal fats and butanol effects on the combustion parameters and on the pollutant emissions. Animal fats-butanol-diesel fuel blends can be considered a viable alternative fuel for diesel engine, assuring the partial replace of the fossil fuels and resolving the major problem of animal wastes

## 1. INTRODUCTION

After the 2015 Paris Climate Conference and the C40 Events-C40 Mayors Summit 2016 diesel engine pollution issue becomes a priority for some capital cities (Paris, Madrid, Athens and Mexico City) which will not legally allow anymore the access of automotives with diesel engines starting with year of 2020.

The use of alternative fuel obtained from renewable sources to diesel engines fuelling is a viable solution for replace of the fossil fuels and for pollutants emissions and greenhouse gases effect decrease. The animal fats have a high potential, due to their good combustion properties and due to great reserves can be used with success at diesel engines. They are oxygenated fuels, non toxic, sulphur free and contain more oxygen compare to diesel fuel [1]. The main disadvantages of animal fats are their high viscosity and poor volatility. Because of their high viscosity, the preheating of animal fats results in a significant decrease of viscosity, which allows the diesel engine fuelling without constructive modifications [2]. By use of butanol in mixture with diesel fuel and animal fats the new fuel viscosity significant decreases and the fuel atomization is improvement [3].

Animal fats are lipid materials, being composed of triglycerides. Animal fats are in more parts constituted from tryglicerides and saturated monocarboxylic fat acids with number of carbon atoms (C12-C18) in which palmitic and stearic acids are predominant [2]. Animal fats have a lower content of carbon and hydrogen and higher oxygen content comparative to diesel fuel. The viscosity of the animal fats is of 15 times greater than diesel fuel at 40°C, table 1, [2]. At the raw animal fats use, the engine power is lower compared to diesel fuelling (the lower heating value of animal fats is with almost 10% lower as the diesel fuel- table 1). By increasing the cyclic fuel dose for the same air/fuel ratio, the engine power can be corrected because of the higher oxygen content of animal fats than diesel fuel [2].

---

<sup>1</sup>Blvd. Splaiul Independentei no. 313, +40723470021, cernatt@gmail.com

In the table 1 a presented some of the physic-chemical properties of diesel fuel and animal fats:

Table 1: The physic-chemical properties of diesel fuel and animal fats

Specific properties of the fuels	Diesel Fuel	Animal Fat
Density [g/ml]	0.8495	0.92
Viscosity at 40 °C [mm <sup>2</sup> /s]	2.96	45
Thick point [°C]	-12	6
Congeaing point [°C]	-16	
Ignition point [°C]	74	170
Boiling point [°C]	191	344
Sulphur [% m]	0.036	0
Cetane number CN [-]	49.2	56
Caloric power Hi [MJ/kg]	42.9	39.77
Carbon [% m]	86.67	77.6
Hydrogen [% m]	12.96	12.3
Oxygen [% m]	0.33	12.5
Oxygen for combustion O <sub>t</sub> [kmol/kg cb]	0.1045	0.0915

Experimental investigations of a diesel engine with a single cylinder, air cooled, with direct injection, fuelled with fuel diesel and animal fat preheated to 70°C in mixture with ethanol showed follow results comparative to diesel fuel engine: increase of the autoignition delay; decrease of the exhaust gas temperature; decrease of NO<sub>x</sub> and smoke emissions level [3, 4]. Same results were presented in others papers [5, 6, 7, 8].

In this paper are presented some results of preheated raw animal fats in mixture with diesel fuel and butanol.

## 2. METHODOLOGY

The experimental investigations were carried on a CFR-IT9-3M experimental diesel engine. The engine was firstly fuelled with diesel fuel and then with blends of diesel fuel-animal fats –butanol for the same engine adjustments (13 °CA injection timing and  $\epsilon=13.74$  compression ratio). The fuel cyclic dose (28.9 mm<sup>3</sup>/cycle) was maintained constant at for all experimental tests. The diesel engine was equipped with AVL pressure transducer line, Kubler speed incremental transducer, real time AVL data acquisition system, AVL gas analyzer and smoke meter, thermo resistances for engine cooling liquid temperature, engine oil and air intake temperatures, and thermocouples for exhaust gas temperature. The high viscosity and poor vaporization characteristics of animal fats need prior their heating and the content limit in mixture with diesel fuel.

Was used the following methodology:

The animal fats are perfect soluble in diesel fuel at ~40 °C. At this temperature were prepared diesel fuel-animal fats (5% and 10% vol.)- butanol (5% vol.) blends.

In figure 1-3 are presented the some effects of the animal fat and butanol in mixture with diesel fuel.

In figure 1 the NO<sub>x</sub> emissions level variation with the animal fats content in mixture with diesel fuel and butanol ( $x_m$ ) is presented.

The NO<sub>x</sub> formation is favored of the high temperature zone associated to the preformed mixtures combustion. Decreasing of NO<sub>x</sub> emission with 65% at the increasing of fats content,

figure 1, is explained by reduction of the preformed mixtures quantity because of the atomization aggravation, which leads to combustion temperature decrease comparative to diesel engine fuelled with diesel fuel, figure 2.

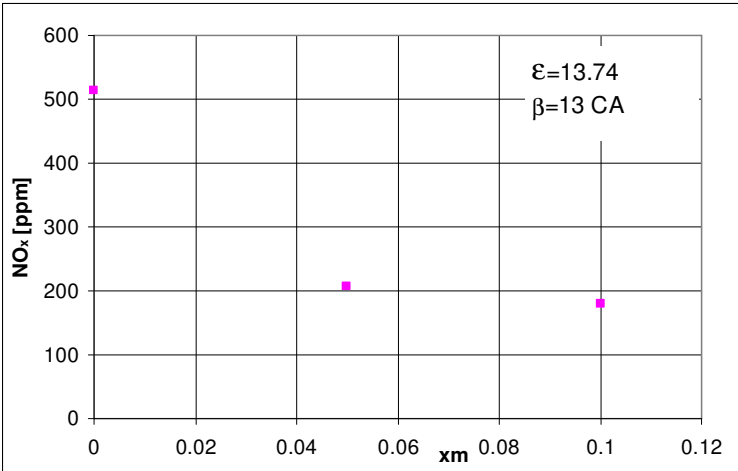

Figure 1: NO<sub>x</sub> emissions level versus animal fats content

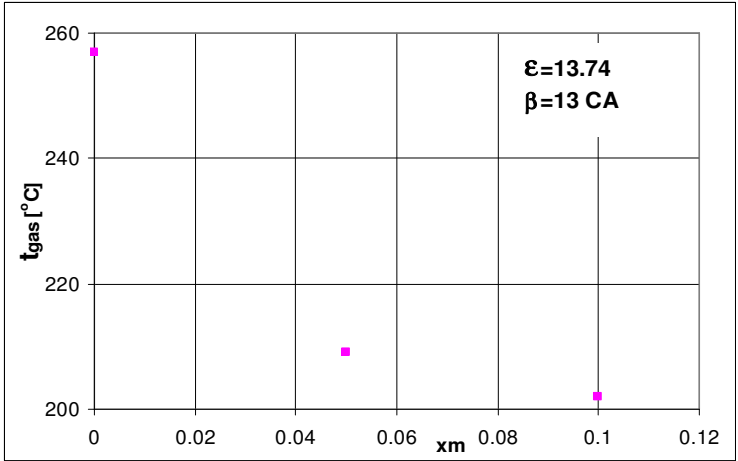

Figure 2: The gas temperature versus animal fats content

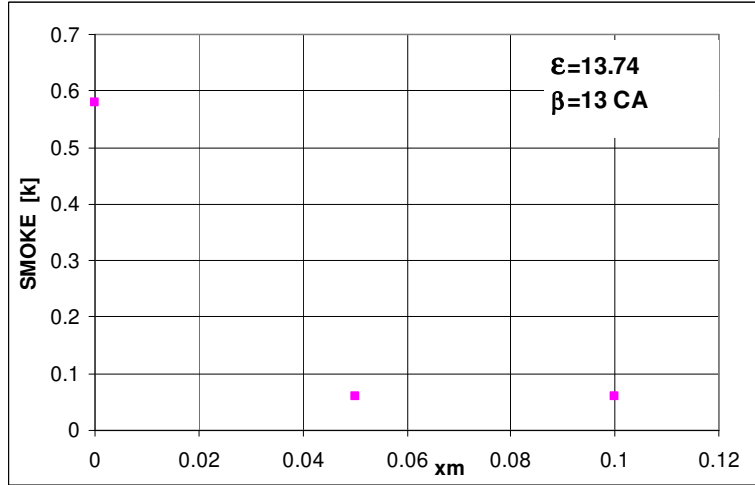

Figure 3: Smoke emissions level versus animal fats content



In figure 3 smoke emission level variations versus the percent of animal fats in mixture with diesel fuel for same butanol content is presented. Reduction of smoke emission level may be explained by carbon content reduction and oxygen content increase at molecular level (the animal fats and butanol have higher oxygen content in their molecule). Comparative to diesel fuel fuelled engine, a reduction with 87% of smoke emission level for  $x_m=10\%$  was obtained.

### 3. CONCLUSIONS

The use of animal fats and butanol in mixture with diesel fuel at the diesel engine assures pollutant emissions decrease. The  $\text{NO}_x$  and smoke emissions level decreases. Animal fats can be considered a good alternative fuel for diesel engine, they achieving the partial replace of the fossil fuels and resolving the major problem of origin animal wastes from leather industry.

#### Acknowledgments

The authors address special thanks to AVL GmbH Graz Austria for providing the necessary equipments. The work has been funded:

- by a grant of the Romanian Ministry of Research and Innovation, CCCDI-UEFSCDI, project number PN-III-P1-1.2-PCCDI-2017-0404/31PCCDI/2018, within PNCDI III”
- by University Politehnica of Bucharest, through the “Excellence Research Grants” Program, UPB – GEX 2017. Identifier: UPB- GEX2017, Ctr. No. 62 /2017
- by the Sectoral Operational Programme Human Resources Development 2007-2013 of the Ministry of European Funds through the Financial Agreement POSDRU/159/1.5/S/134398

#### References

- [1] Venkatraman, M., Devaradjane, G., ”*Effect of Compression ratio, Injection Timing and Injection Pressure on a DI Diesel engine for better performance and emission fueled with diesel-diesel biodiesel blends*“, International Journal of Applied Engineering Research, Vol. 1 , No 3 , 2010.
- [2] Gheorghe Lazaroiu, Constantin Pană, Lucian Mihaescu, Alexandru Cernat, Niculae Negurescu, Raluca Mocanu, Gabriel Negreanu, „*Solutions for energy recovery of animal waste from leather industry, Energy Conversion and Management*“, pp: 1-11, ISSN: 0196-8904, June 2017.
- [3] Oguzhan Dogan, *The influence of n-butanol/diesel fuel blends utilization on a small diesel engine performance and emissions*, Fuel 90, pp. 2467–2472, 2011.
- [4] Kerihuel, A., Kumar, M., S., Bellettre, J., Tazerout, M., “*Investigations on a CI Engine Using Animal Fat and Its Emulsions with Water and Methanol as Fuel*”, SAE International, Paper Number 05P-95, 1995.
- [5] Senthil, Kumar, M., Kerihuel , A., Bellettre, J., Tazerout, M., “*A Comparative Study of Different Methods of Using Animal Fat as a Fuel in a Compression Ignition Engine* “ , Journal of Engineering from Gas Turbines and Power, Vol. 128, October 2006.
- [6] Cernat, A., Pana, C., Negurescu, N., Lazaroiu, Gh., Nutu, C., *Aspects of the animal fat use at the diesel engine fuelling*, UPEC 2015 Proceedings of Staffordshire University, 2015.
- [7] Srinivasa, Rao, K., Ramakrishna, Dr.A., Rao, P.V., *Performance and emission characteristics of DI-CI diesel engine with preheated chicken fat biodiesel*, International journal of mechanical engineering and technology, volume 4(3), 2013.
- [8] Kumar, A., Kerihuel, J., Bellettre, M., Tazerout, M., *The use of preheated animal fat as fuel in a compression ignition engines*, Renewable Energy, volume 30(9), pp:1443-1456, 2005.

# EXPERIMENTAL INVESTIGATION OF PARABOLIC TROUGH SOLAR COLLECTOR (PTC) PERFORMANCE FOR WATER DESALINATION

Dhafer Manea H. Al-Shamkhee<sup>1</sup>, Essam. Oun Ali. Al-Zaini<sup>2</sup>, Qahtan A Abed<sup>3</sup>

<sup>1,2,3</sup> *Dr. Eng. Al-Furat Al-Awsat Technical University, Engineering Technical College- Najaf, Iraq.*

## ABSTRACT

Due to depleting traditional energy resources, solar energy appears a promising alternative renewable preference for many demonstrational applications including solar desalination plants. In this respect, an experimental study on the performance of pre-designed and manufactured Lab-scaled water desalination used parabolic trough solar collector PTC was carried out for the first time in Al-Najaf City-Iraq (32° 1' N / 44° 19' E). The proposed designed is to enhance the production of the water still by integrated with a parabolic trough solar. The used PTC with 90°-rim angle mirrored reflector that focused the sun on its focal line of a copper tube with black chrome coating receiver. Primary results reveal 11% improvement in system efficiency is obtained over the used vacuumed copper tube with black chrome coating receiver. Results also confirm PTC facing North or South positions is best for maintaining better system efficiency.

**Keywords:** Solar distillation, parabolic trough solar collector, condensation, Solar radiation.

## 1- INTRODUCTION

It is well known that worldwide regions with scarce sources of pure consumable water are having abundant solar energy. Conventional technology of desalinating saline water in such dry regions such as thermal processes is well discovered, implemented and developed. These including multiple effects, multi-stage flash and more recently humidification dehumidification process. Such practices are yet claiming high energy input rates due to the vaporization phase change of saline water [1].

In this respect, utilizing solar energy technology for desalination appears as superior choice of being renewable energy that promotes higher environmental and living standards within such regions. In this respect, trough solar concentrator technology for desalination applications is attractively growing research topic [2-5]. Parabolic trough solar collectors are a type of concentrating collectors used in thermal power plants. They consist of a reflective mirror in the shape of a parabola, a tubular receiver, and support structures. The collector uses the solar incident rays from the sun, reflecting them onto a tubular receiver. The tubular receiver is placed at the focal point of the parabola for effective reflection of the sun's rays onto the fluid inside the receiver [6].

Riffat and Mayere [2] investigated the performance of v-trough solar concentrator for desalination applications. They reported that the v-trough solar concentrator is a superior technique for small and medium water desalination, since the efficiency reaches 38% at 100°C temperature of transfer fluid at the concentrator outlet. Joo and Kwak [3] conducted an optimization study of solar thermal desalination over a small-scale multi effect distiller. Their results revealed an optimal ratio of 2.0.

The performance evaluation of combining desalination systems with concentrated solar power plants was conducted by Palenzuela et al. [4]. They concluded that a low temperature

---

<sup>3</sup> Corresponding author, email [qahtan77@yahoo.com](mailto:qahtan77@yahoo.com)

multiple-effect distillation is more efficient than a low temperature multiple effect distillation integrated with a thermal vapour compression. A multiple-effect distillation system was investigated through a dynamic model generated by Calle et al. [5]. They reported that their generated model could be used to optimize the operating control of such systems. Yanjuan Wang et al. [7]. Carried out numerical simulation combining solar ray trace (SRT) method and finite element method (FEM) to solve problem coupled with fluid flow, heat transfer and thermal stress in a PTC system. Their results revealed that the circumferential temperature difference (CTD) of the absorber decreases with the increases of inlet temperature and velocity of the heat transfer fluid (HTF) and increases with the increment of the direct normal irradiance (DNI). They also reported that the thermal stress and the deformations of the absorber are higher than that of the glass cover. They concluded that their findings could provide a fundamental reference for the development of the parabolic trough solar thermal power plant in China.

The present study is focused on the amount of freshwater productivity of a solar still integrated with the parabolic trough collector in natural mode. The system has been optimized to increase the heat transfer coefficients by adding a heat exchanger coil.

## 2- EXPERIMENTAL SETUP

The experimental work involved experiments conducted on the solar parabolic trough (PTC) with distillation system. The performance of a locally designed and build PTC for water desalination application was investigated. Collected weather data including air temperature, solar radiation and wind speed was well considered in the experimental work. Where the work divided into two parts; the first part discusses efficiency of the parabolic trough collector and the second part discusses water desalination by use of parabolic trough collector. The PTC was made of a stainless-steel sheet in order to facilitate reflection and concentration of sun radiations towards an absorber tube located at the focus line of the parabolic. The receiver in turn is an absorber tube is made of copper at which point it absorbs the incoming radiations and transforms them into thermal energy, the last being transported and collected by a fluid medium circulating within a tank filled with saline water at which point it evaporates. Pure water then collected as a result of water condensation. The Specification of the used PTC are detailed in table1 below.

Trough length(L)	1.99m
Aperture (a)	0.85m
Aperture area = L*a	1.99*0.85=1.6915m <sup>2</sup>
Height trough	1.74 m
Absorber material	Black steel
Rim angle	90°

To achieve cost-effectiveness in mass production, the collector structure must feature not only a high stiffness-to-weight ratio, to keep the material content to a minimum, but also to consider low-labor manufacturing processes. A steel parabola framework was designed and manufactured where it has been covered with a highly reflective Stainless-steel sheet as shown in Figure 1. The PTC was positioned facing the south direction in order to ensure a maximum amount of solar radiation to be received. Reflected solar radiation then directed to the receiver tube in its focal line.



Figure 1. Experiment parabolic trough solar with the receiver

The second part of this work is the distillation collector (See figure 2). The temperatures of the distilled water downstream of the pre-heating section, at the inlet and at the outlet of the receiver and downstream of the heat exchanger are measured by thermocouples as well.

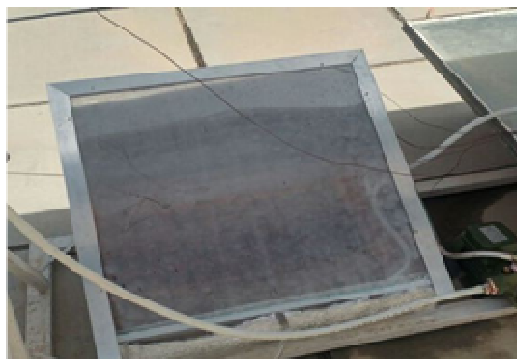

Figure 2. Photographic side view of the distillation water

### 3- RESULTS & DISCUSSION

Solar radiation affects the performance of the PTC due to the fact that its intense varied along day cycle which in turn reflects its amount absorbed by the receiver. Figure 3, highlights the solar radiation-temperature relationship over two days running. Obviously, maximum radiation was recorded at 12:30 pm scoring as high as 962 where the highest temperature of 40.5 °C was obtained at 3:30 pm on 15/5/2018. On another day, an optimal radiation was reported at 12:10pm of 940 where highest temperature of 44.3°C obtained at 2:30pm.

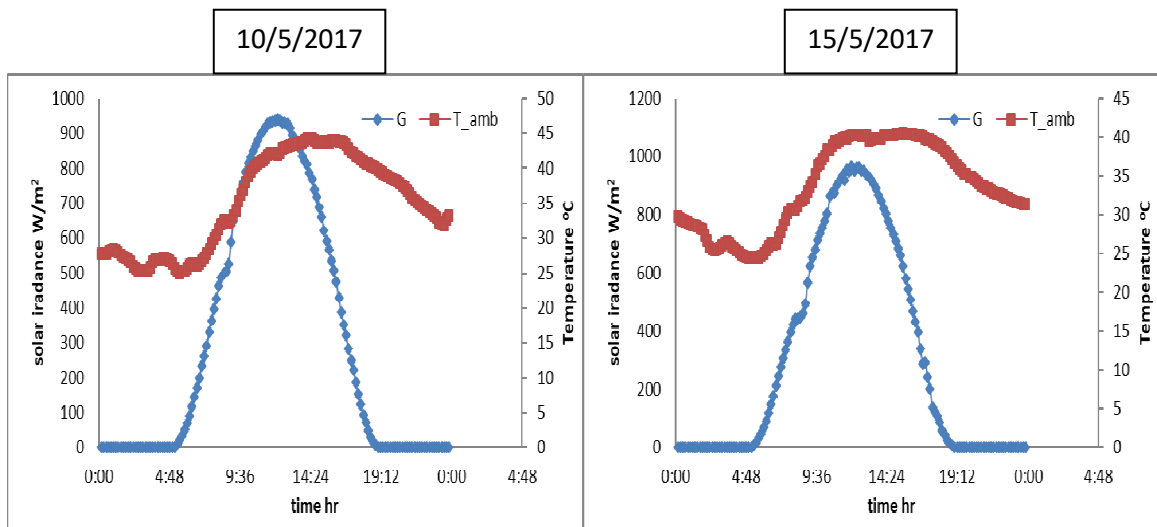

Figure 3. Solar radiation and ambient temperature variation with time at 10 and 15/5/2017

The experimental results of PTC with solar still for fresh water are reported and discussed first. The daily thermal efficiency, for the PTC with solar still was acquired by the summation of the total hourly condensate production for fresh water, multiplied by the latent heat of water vaporization and divided by the product of daily solar radiation and the whole area of the collector.

$$\eta_d = \frac{\sum M \cdot h_{fg}}{\sum I \cdot A}$$

In the experimental results, Figure 4 shows the relationship between time and temperature inlet, outlet and surface temperature of absorber pipe recorded on 10 and 15/5/2017 respectively. Generally, on 10/5/2017, it should be mentioned that all temperatures were increased with time. However, a 10°C decline in surface tube temperature at 12:10pm. This is mainly due to poor contact between the temperature sensor and the tube surface. The error was less pronounced on the results obtained on 15/5/2017 as can be shown in Figure 4.

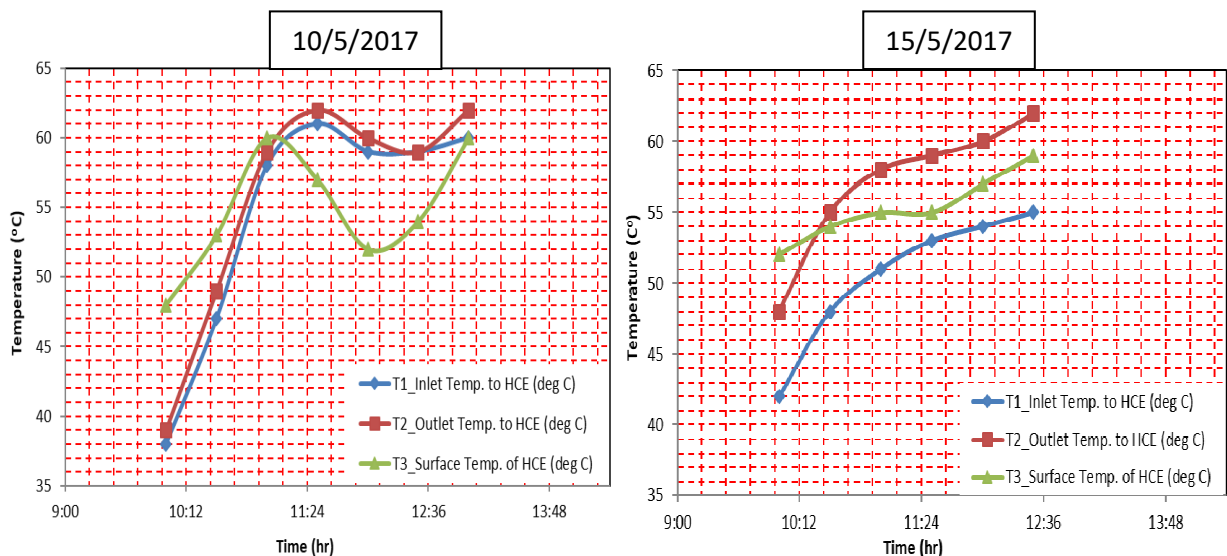

Figure 4. Variation of the inlet, outlet and surface temperature of the PTC with Time for two days

The Figure 5 displays the time-coil surface temperature relationship (T5- water in basin), the temperature of the glass surface (T7- condensation surface) and temperature of moisture air (T8) during the two experimental days 10/5/2018 and 15/5/2018. It can be noticed that the glass surface temperature was the lowest compared to those for the coil surface and moisture air. The difference in temperature also increased with time due to evaporation process takes place in the basin as result of increased solar radiation.

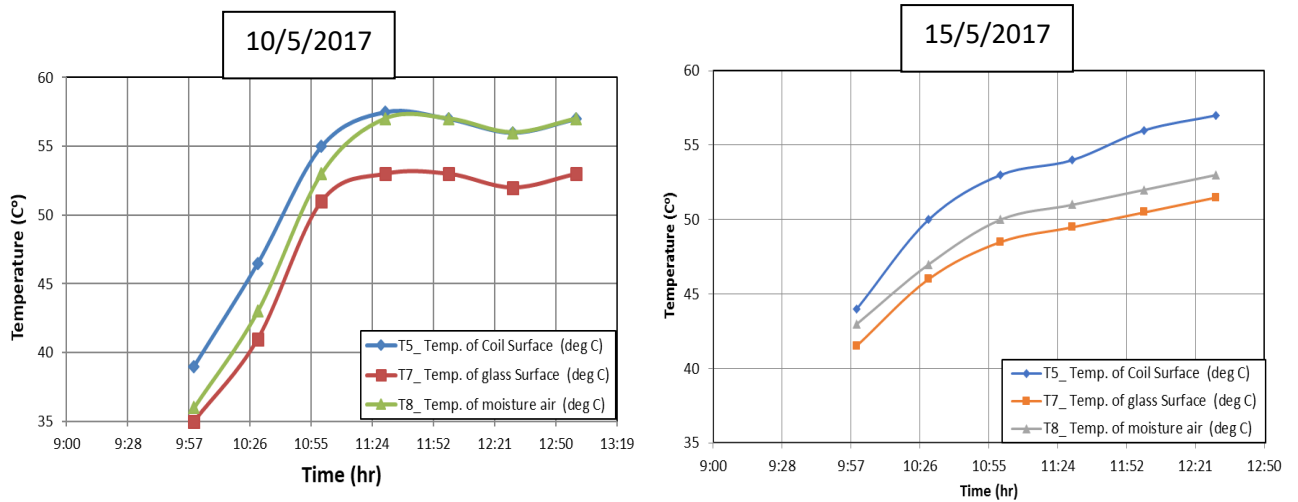

Figure 5. The Relationship between Time and Temperature of Coil Surface (T<sub>5</sub>- Water in Basin), The Glass Surface (T<sub>7</sub>- Condensation Surface) and Moisture Air (T<sub>8</sub>) of two days

The Figure 6 shows the relationship between time and productivity for two days (10/5/2018 & 15/10/2018). It can be noticed that highest productivity was calculated at 12:00pm and lower of productivity at 10:30am on 10/5/2018. Similarly, highest productivity was obtained at 12:00pm on 15/10/2018. Beyond 12:00pm, a noticeable reduction in system productivity was recorded mainly due to reduced water evaporation effect as a result of declined solar radiation.

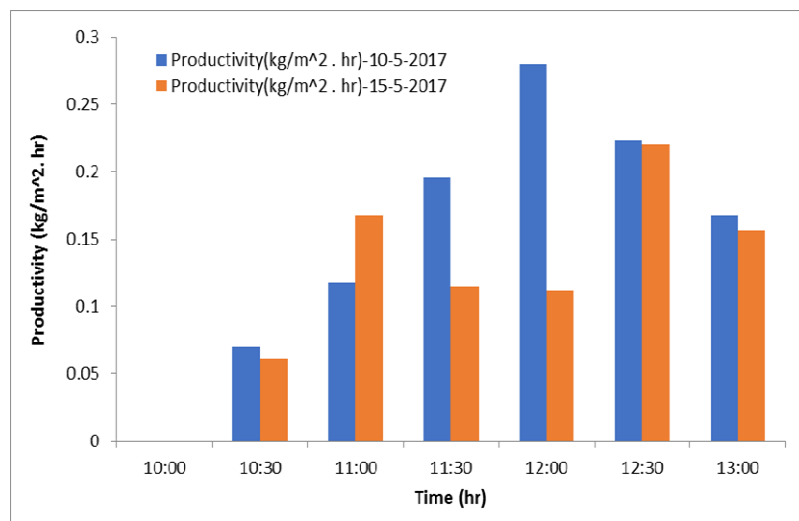

Figure 6. Productivity of fresh water for two days (10/5/2018 and 15/10/2018)

#### 4- CONCLUSIONS

This paper reports the performance of pre-designed and manufactured Lab-scaled parabolic trough solar collector PTC for water desalination application for the first time in Al-Najaf City- Iraq ( $32^{\circ} 1' N / 44^{\circ} 19' E$ ). Experimental outcomes indicate that PTC with single slope solar still system yields a relatively higher productivity of fresh water over traditional solar still systems approaching 5%. It also reported a significant growth in system production could be achieved with expanding the solar collecting space. In this respect, it can be concluded that PTC desalination systems appears to be superior approach in country like Iraq.

#### References

- [1] Fahad A. Al-Sulaiman, M.I.Z., Maimoon Atif, Palanichamy Gandhidasan, Salem A. Al-Dini, Mohamed A. Antar, Humidification dehumidification desalination system using parabolic trough solar air collector. *Applied Thermal Engineering* 2015. 75: p. 809-816.
- [2] Riffat, S. and A. Mayere, Performance evaluation of v-trough solar concentrator for water desalination applications. *Applied Thermal Engineering*, 2013. 50(1): p. 234-244.
- [3] Joo, H.-J. and H.-Y. Kwak, Performance evaluation of multi-effect distiller for optimized solar thermal desalination. *Applied Thermal Engineering*, 2013. 61(2): p. 491-499.
- [4] Palenzuela, P., et al., Evaluation of cooling technologies of concentrated solar power plants and their combination with desalination in the mediterranean area. *Applied Thermal Engineering*, 2013. 50(2): p. 1514-1521.
- [6] De la Calle, A., et al., Dynamic modeling and performance of the first cell of a multi-effect distillation plant. *Applied Thermal Engineering*, 2014. 70(1): p. 410-420.
- [7] Mohamed S. Shahin, M.F.O., Faruk Uygul, Thermodynamic analysis of parabolic trough and heliostat field solar collectors integrated with a Rankine cycle for cogeneration of electricity and heat. *Solar Energy*, 2016. 136: p. 183-196.
- [8] Yanjuan Wang, Q.L., Jing Lei, Hongguang Jin, Performance analysis of a parabolic trough solar collector with non-uniform solar flux conditions. *International Journal of Heat and Mass Transfer*, 2015. 82: p. 236-249.

# MODELING OF HEATING SECTOR DEVELOPMENT WITH TRANSITION TO BIOMASS-BASED GENERATION SCENARIO TILL 2050 IN UKRAINE

Epik A.<sup>1</sup>, Junior Researcher, Zubenko V<sup>1</sup>, Junior Researcher

## ABSTRACT

Current work is devoted to the modeling calculation aimed on answering the question of how the heating sector will look like after transformation from current fossil fuel generation to potential RES-based generation till 2050: what equipment, fuel types will be used, how energy consumption will change, what are the limitations in the sectors, drivers of development of RES in heating sector, needed investments, CO<sub>2</sub> reductions and jobs created according to the installations implemented. The results of such modeling could demonstrate principal possibility of achieving of determined RES-based heat generation targets drawing up the heating sector architecture till 2050.

**Keywords:** renewable energy sources, heat generation, agrobiomass, total primary energy supply, gross final energy consumption.

## 1. INTRODUCTION

Ukrainian heat generation sector is currently one of the most energy intensive sectors with the large share of fossil fuel based generation (more than 90%). At the same time, the substantial development of renewables is only observed in the heat generation sector as shown at Figure 1. Total share of heat energy demand out of all energy demand in Ukraine is for 2016 more than 30% in total final energy consumption [1]. Despite number of latest state programmes and plans [2], [3], [4], [5], [6], [7] of sector reform it is still unclear what is the primary tendency of its development and the driving forces for the post-2020 period and how exactly and to what state it can transform. In the meantime, while maximum projection horizon for Ukraine is now 2035, there are new international realities which Ukraine already encountered as the Associated EU Member State and a Party of Energy Community (Paris Agreement, available plans on 100% RES in some of the EU member states, etc.). This requires widening of the projection horizon at a minimum till 2050.

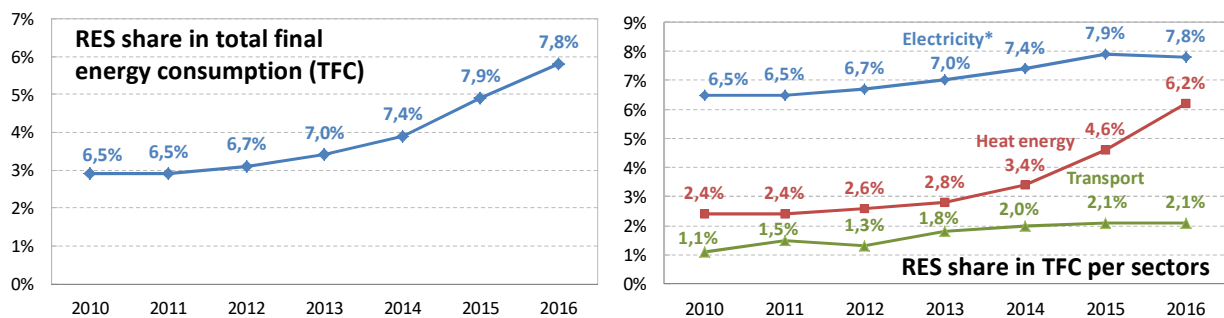

Electricity\* – including large hydro power

Figure 1: Developments of RES in Ukraine according to official statistics, 2010-2016

Available prognoses are focused more on traditional fuel types and energy sources and are sometimes contradictory with each other. There is no detailed sectoral specification thus they could not serve as road map for heating sector development. Meanwhile one of the possible and perhaps most economically plausible scenarios may be fuel switch from fossil fuel to

<sup>1</sup> Institute of Engineering Thermophysics of NASU, Zhelyabova 2a street, tel.: +38 044 453 28 56, e-mail: [zubenko@biomass.kiev.ua](mailto:zubenko@biomass.kiev.ua); [epik@biomass.kiev.ua](mailto:epik@biomass.kiev.ua);



biomass-based heat generation, for which from one hand the legislative and economic preconditions are more or less already in place but signal for investors in form of some strategic document is absent.

To improve current situation with post-2020 vision and providing well-grounded data for decision making, more precisely estimate policies needed to reform district heating sector with respect to increasing of renewable energy based heat generation it is crucial to discover the details of heating sector development, what will be the principal structure of sector, heat energy demands, sources of energy and their niches in the sector, equipment used for longer planning horizon. The distribution of biomass and RES types used, respective heat prices and how the technological competitiveness will influence the overall state of heating sector, subsectors within it, interconnects with other sectors and changes over time for post-2020 period is necessary for understanding principal possibility or impossibility of achievement of respective RES share in heat generation. Such work is the first step to demonstrate the possibility of high level of RES implementation in heating sector of Ukraine, showing the trajectories of how it could be achieved and biomass/RES types engaged.

**2. APPROACH AND METHODOLOGY**

The modeling touches only heating sector with inclusion of all generation-side installations operating in the sector. The general idea of the modeling approach is based on the identification of quantity of RES equipment and energy produced for each of 3 heating subsectors (individual heating of population, district/budget heating (DH), industrial heating) and for all currently eligible RES types (all kinds of biomass, biogas, MSW, solar heating and heat pumps) for different equipment categories (individual stoves, small, all kind of biomass boilers (medium and large scale hot water and steam boilers), CHPs MSW incineration, biogas cogeneration on ICE basis, solar collectors (roof and stationary) and heat pumps (aero)). The modeling is performed for the step of 5 years till 2050 with the iterations performed on each step of calculation. At the beginning of calculation process, the matrix including all eligible RES types for different equipment categories is built. The combinations of pairs “biomass type” ↔ “technology used” have large number of possible solving alternatives in time. The model is designed to narrowing the quantity of possible solving trajectories and define so-called “balanced” trajectory of RES development on the basis of integration of different constraints, limitations and thresholds for initial and final data produced by the model (see the principal schematic diagram at Figure 2).

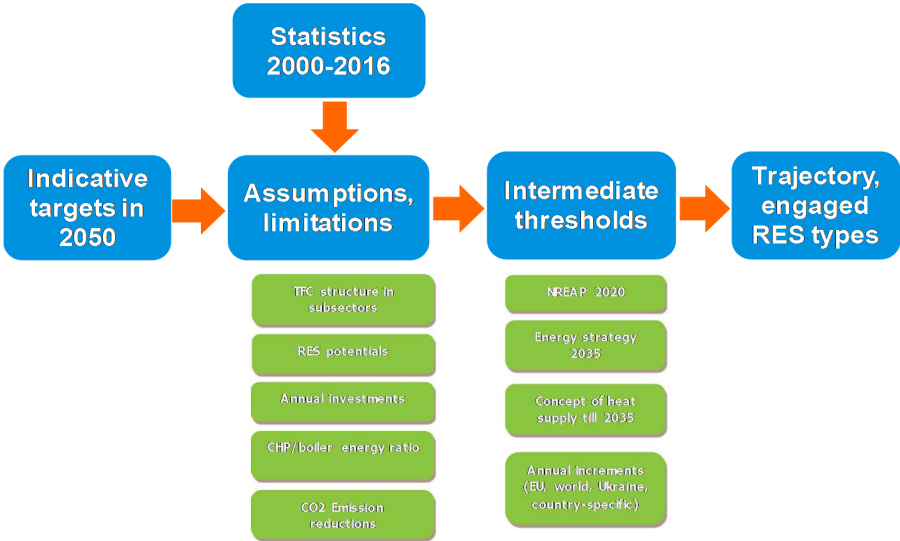

Figure 2: Schematic diagram of modeling approach

The first iteration of model may be simply performed for example as extrapolation of existing statistical data. After obtaining of results of first iteration the output data is analyzed with respect to contradiction of set limitations of the model. If at least one limitation is not satisfied, the iteration is repeated once more. The final data on equipment and biomass types used shall satisfy all integrated limitations (some of which are in contradiction with each other which is narrowing the possible projected trajectory even more). The iterations of energy data for each modeling step (5 years) is performed as long as all set limitations are satisfied without any contradictions. After this calculation is deemed final. The main constraints and limitations used in the model are presented on the diagram below on Figure 3.

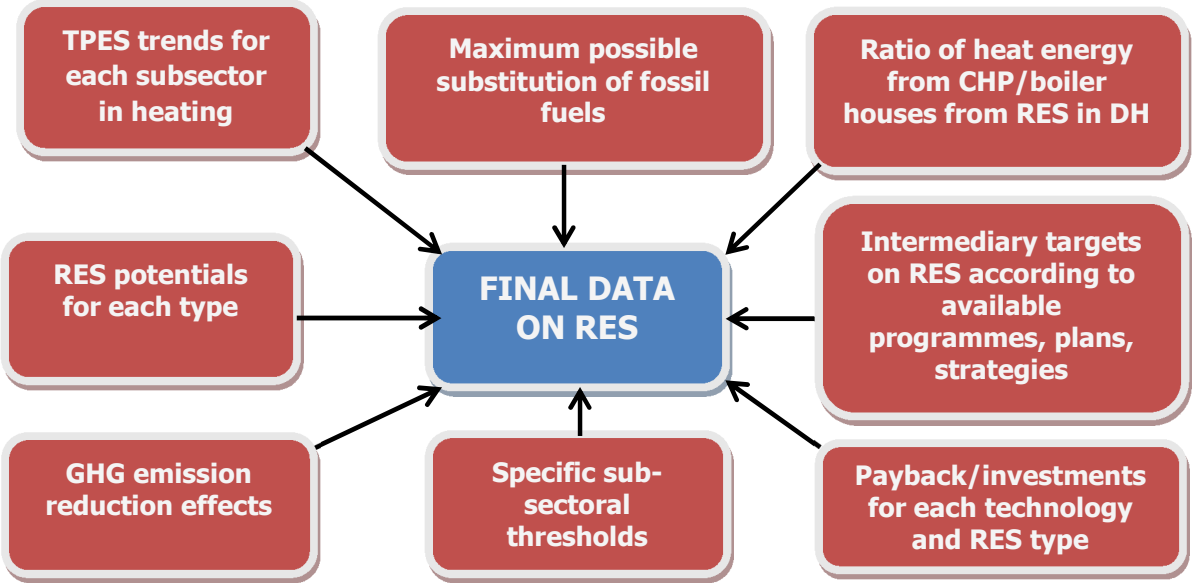

Figure 3: Key assumptions, constraints and limitations used for model balancing.

Graphical representation of the modeling approach is represented at Figure 4. The blue line represents the energy statistics with simple linear extrapolation serving as reference first iteration. All next trajectory data is generating after applying of certain limitation packs which adjust previous data arrays. The final scenario – so-called “balanced” shown by orange line at Figure 4 is satisfying all applied limitations and so is deemed final.

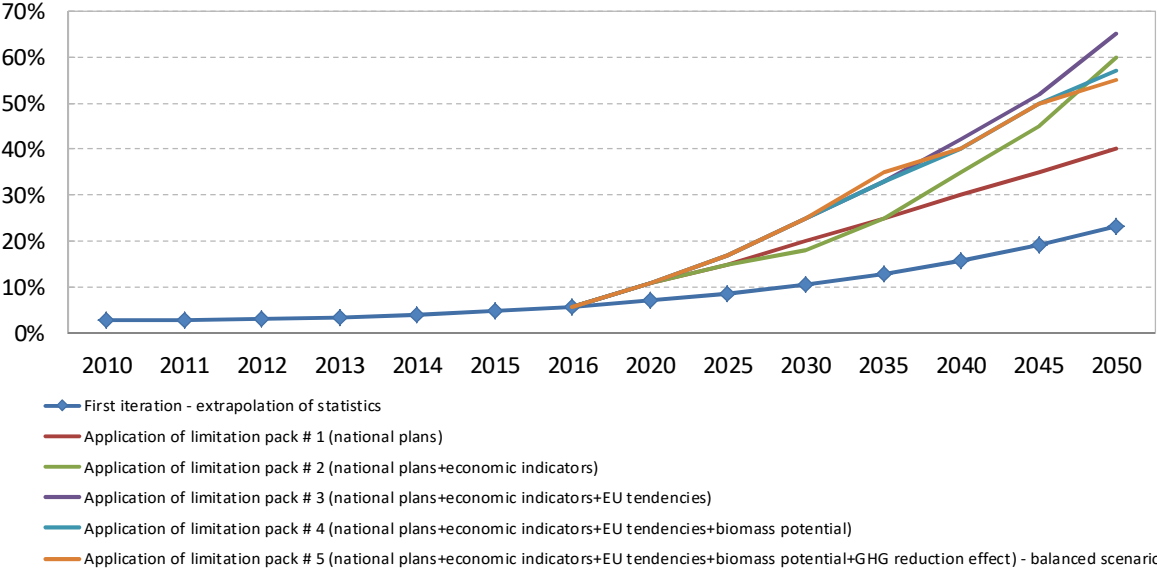

Figure 4: Graphical representation of iteration-based method using different limitations packs

The model also calculates jobs and investments needed for achieving the respective scenario. Investments are determined according to project specific data currently known and typical for Ukrainian conditions prior to the iterations. For each technology/RES type the capital investments are incorporated in model with tendency of decreasing through time. Also simple payback is calculated on the basis of investments through standard method of dividing of capital costs on operational savings appearing due to replacement of fossil fuels by RES (difference between energy cost from RES and baseline – natural gas). It should be mentioned also that total investments for sector and each subsectors are serving as additional threshold per each iteration (making iteration cycling).

Jobs are calculated according to standard jobs factors multiplying the calculated heating capacities for each technology/subsector/RES/type on the respective factors jobs/MW<sub>th</sub> according to international and national level data [7], [8], [9].

For the purpose of modeling, natural gas consumption in all heating sector for all subsectors is remaining stable (on the current level) for all steps of modeling till 2050.

### 3. CONSOLIDATED RESULTS AND DISCUSSION

To obtain final results for district heating sector it is necessary to determine the input of RES for all heating subsectors in Ukraine, including district heating, industrial (processing) heating and individual heating of population otherwise the RES input in DH subsector may be not balanced (for example, overestimated for population and underestimated for district heating). So the model is working on the level of all three subsectors, as specified above. Below the results of the model iteration with application of above mentioned limitations are presented in consolidated manner specifically for three subsectors.

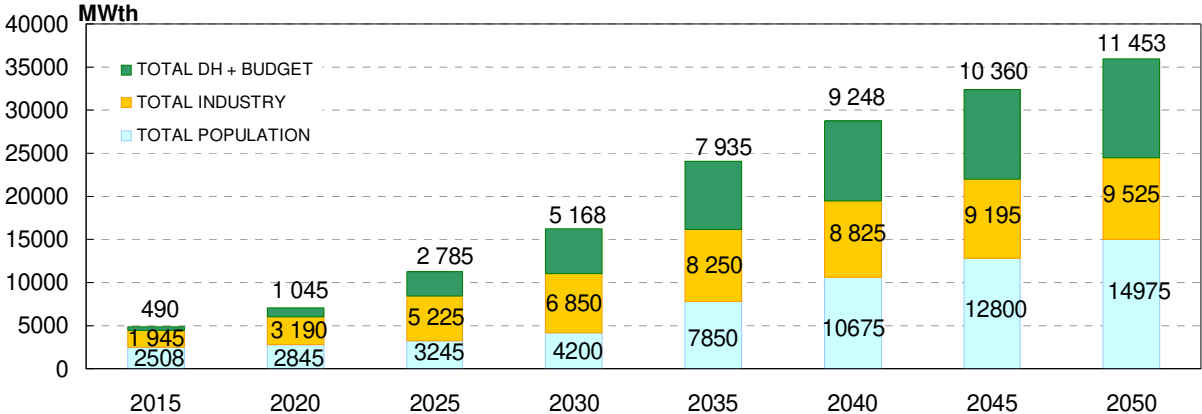

Figure 5: Total installed capacity of RES (MW<sub>th</sub>) in heating sector

According to the final modeling data, total installed capacity of RES overall for heating sector is increased from 5 GW<sub>th</sub> in 2015 to 35 GW<sub>th</sub> in 2050 (Figure 5) and the total primary energy supply (TPES) from RES is increased from 2.6 Mtoe to 13.8 Mtoe in 2050 (Figure 6). RES share overall for heating sector is increasing from 10% in 2015 to 57.4% for 2050.

According to calculation over 145 000 jobs in 2050 are to be created in heating sector: 60 000 in DH and public heating, 48 000 in industry, 38 000 in population individual heating. The most job-intensive technologies are CHP on agroresidues and energy crops (9-11 jobs/MW<sub>th</sub>), MSW incineration (7-8 jobs/MW<sub>th</sub>), large industrial boiler houses (4 jobs/MW<sub>th</sub>), solar and heat pumps (3-5 jobs/MW<sub>th</sub>), the less job-intensive are individual stoves and small biomass boilers (1-2 jobs/MW<sub>th</sub>). Total investments needed for the scenario realization are on the level of 11.5 billion EUR for the period 2015-2050. The distribution of

investments is variable for each 5 year periods achieving maximum during 2030-2035 and then gradually decreasing.

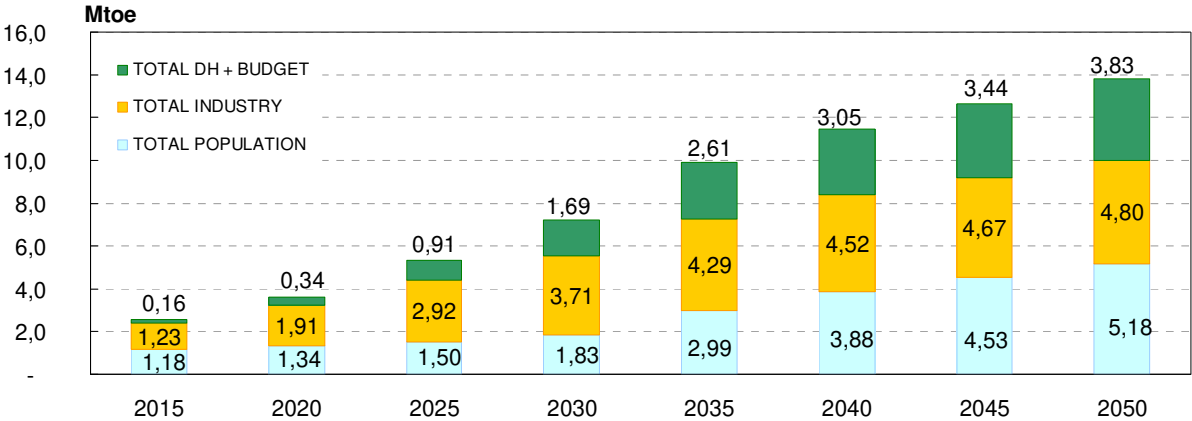

Figure 6: TPES from RES (Mtoe) in heating sector

The RES types engaged in heat production are represented on Figure 7. It could be seen that for 2050 13 Mtoe out of 13.8 Mtoe (more than 90%) is represented by different biomass types, mainly agrobiomass. In 2015 80% of biomass used is different kinds of woody biomass, in 2035 – 35%, in 2050 – only 20%. The utilization of woody biomass potential is currently approaching to the maximum, so the lion share of developments in biomass-to-heat generation in the future may be performed only with utilization of non-woody biomass types, mainly agrobiomass (>50% in the TPES balance for 2050).

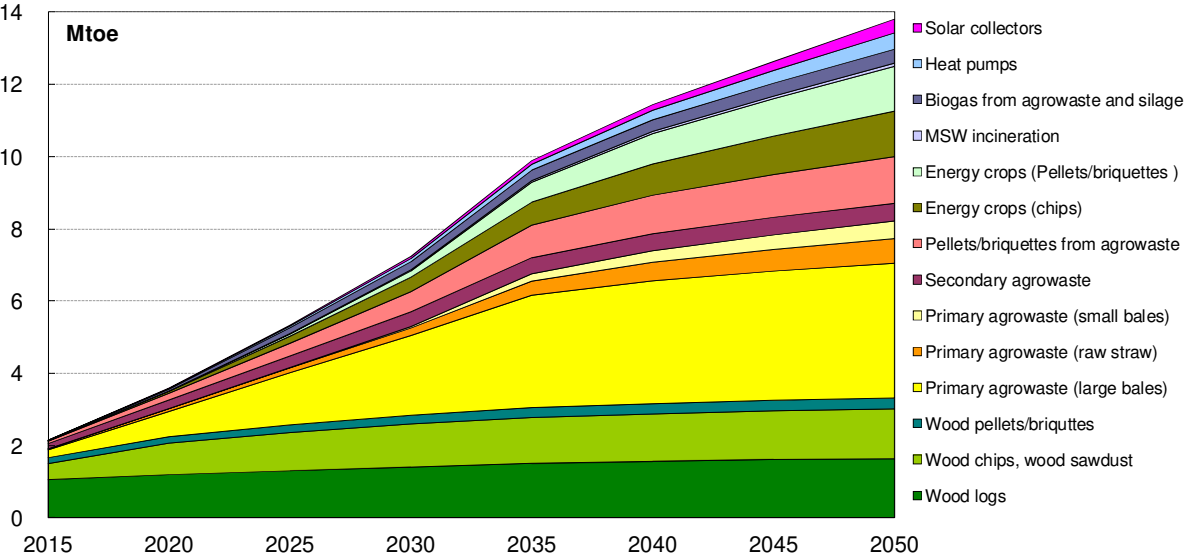

Figure 7: Heat production by different biomass types, solar collectors and heat pumps

#### 4. CONCLUSIONS

The modeling of the RES-to-heat generation scenario till 2050 demonstrated the following key indicators:

1. The overall heat production from RES is achieving 13.8 for 2050 comprising 57% RES share: 5.2 Mtoe in individual heating, 3.8 Mtoe – in DH and budget/public heating and 4.8 Mtoe – in industrial heating;

2. The overall installed RES-to-heat generation capacities in 2050 are 36 GW<sub>th</sub>: 15 GW<sub>th</sub> – individual heating, 11.5 – DH and budget/public heating, 9.5 – industrial heating;
3. The main increasing of RES-based heat generation in relative values is observed in the district heating and budget/public heating (from 0.16 Mtoe in 2015 to 3.8 Mtoe in 2050 or more than in 20 times);
4. The largest absolute amount of RES-based heat generation is observed in the individual heating of population (5.18 Mtoe in 2050);
5. Energy potential of RES is not fully exhausted, except of woody biomass (utilization on the level of 110% of available potential), secondary agrowastes (98.8%) and sunflower residues (80%); the main reserves for post-2050 developments are in wheat straw and maize straw, energy crops, biogas from manure/agrowaste and MSW incineration, non-biomass RES types – heat pumps and solar heating technologies;
6. Without agrobiomass (total share used in heating till 2050 from all RES over 60%) and energy crops (approximately 20%) it is impossible to achieve targets of the high RES utilization in heating according to the modeled scenario;
7. Agrobiomass and energy crops are main biomass types used in post-2030 period in individual heating and DH, secondary and primary agrowastes, manure for biogas and woody biomass are main types used in industry for same period;
8. Total investments for the scenario is 11.5 billion EUR overall for heating sector, out of which 1.6 billion is invested in installations for individual heating, 5.0 billion – in DH and budget/public heating, 4.9 billion – in industrial heating;

## References

- [1] Energy Balance of Ukraine, 2016. Official issue:  
[https://ukrstat.org/en/operativ/operativ2017/energ/en\\_bal/Bal\\_2016\\_e.zip](https://ukrstat.org/en/operativ/operativ2017/energ/en_bal/Bal_2016_e.zip)
- [2] Heat Supply Concept of Ukraine (in effect, 18 August 2017):  
<http://zakon2.rada.gov.ua/laws/show/569-2017-%D1%80>
- [3] New Energy Strategy till 2035 “Efficiency, Security, Competiveness” (in effect, 18 August 2017):  
[http://mpe.kmu.gov.ua/minugol/control/uk/publish/article?art\\_id=245230270&cat\\_id=35109](http://mpe.kmu.gov.ua/minugol/control/uk/publish/article?art_id=245230270&cat_id=35109)
- [4] National Concept of Climate Policy Realization in Ukraine till 2030 (in effect, 2016):  
<http://zakon2.rada.gov.ua/laws/show/932-2016-%D1%80>
- [5] National Strategy of Regional Development for the period till 2020 (in effect, 2015)  
<http://zakon2.rada.gov.ua/laws/show/385-2014-%D0%BF>
- [6] National Renewable Energy Action Plan of Ukraine till 2020 (in effect, 2014)  
[http://sae.gov.ua/documents/NpdVE\\_eng.pdf](http://sae.gov.ua/documents/NpdVE_eng.pdf)
- [7] National Energy Efficiency Action Plan till 2020 (in effect, 2014) :  
[http://sae.gov.ua/documents/NpdEE\\_eng.pdf](http://sae.gov.ua/documents/NpdEE_eng.pdf)
- [8] The Stage of Renewable Energies in Europe. Edition 2016. 16<sup>th</sup> EurObserv’ER Report. Issued by: EurObserv’ER:  
<https://www.eurobserv-er.org/16th-annual-overview-barometer/>
- [9] Renewable Energy and Jobs: Annual Review 2017, issued by IRENA:  
[https://www.irena.org/DocumentDownloads/Publications/IRENA\\_RE\\_Jobs\\_Annual\\_Review\\_2017.pdf](https://www.irena.org/DocumentDownloads/Publications/IRENA_RE_Jobs_Annual_Review_2017.pdf)
- [10] Renewables 2016. Global Status Report. Issued by REN 21:  
[http://www.ren21.net/wp-content/uploads/2016/05/GSR\\_2016\\_Full\\_Report\\_lowres.pdf](http://www.ren21.net/wp-content/uploads/2016/05/GSR_2016_Full_Report_lowres.pdf)
- [11] Geletukha G. Zheliezna T. State of the Art of Bioenergy Developments in Ukraine, Industrial Heat and Power Engineering, Vol. 2, # 39, ISSN 0204-3602, 2017:  
<http://uabio.org/img/files/news/pdf/state-of-the-art-and-prospects-for-bioenergy-development-in-ukraine.pdf>
- [12] IRENA REMAP-2030 “Perspectives of RES Developments in Ukraine till 2030”:  
<http://sae.gov.ua/sites/default/files/UKR%20IRENA%20REMAP%20%202015.pdf>

# CAPILLARY-POROUS COOLING SYSTEMS FOR MELTING UNITS

Alexander A. Genbach<sup>1</sup>, Nellya O. Jamankulova<sup>2</sup>, Iliya K. Iliev<sup>3</sup>

<sup>1,2</sup>Almaty University of Power Engineering & Telecommunications,  
Heat power engineering faculty, Republic of Kazakhstan, Almaty,

<sup>3</sup>Ruse University, Ruse, Bulgaria

## ABSTRACT

A capillary-porous cooling system for caissons of melting units has been studied. The use of these systems in metallurgical production is large-scale and multi-purpose. Devices in the form of box-type caissons have a high intensity of heat transfer, remove high heat loads and provide explosion-proof operating conditions for melting units. A new capillary-porous cooling system that contains a small amount of coolant and is explosion-proof for operation of melting units has been developed and investigated. Engineering calculation of operating and limiting characteristics of a capillary-porous cooling system was done. The installation of box-type caissons in the slag zone of melting furnace and installation of an evaporative and condensation capillary - porous cooling system of details (caissons) are shown.

**Key words:** capillary-porous system, cooling system, caisson, heat flux, melting unit.

## 1. INTRODUCTION

The most important factor in the intensification of energy production is the rising of the economy regime, taking into account the requirements of the environment. It is necessary to meet the growing demand for fuel, energy and raw materials, mainly by saving material and raw materials, improving the use of secondary resources. The solution of these problems can be facilitated by porous systems.

Porous systems are beginning to be introduced in power installations. They allow to remove and transport great heat fluxes with high intensity and reliability, to solve a number of environmental problems as a result of anthropogenic impact on the environment, to promote the saving of natural resources, water and oxygen, to reduce the amount of harmful emissions.

Capillary-porous systems are used in metallurgical production and have a multi-purpose nature. In metallurgical units, parts and assemblies operate in a highly heat-loaded state and require intensive cooling. Moreover, in the case of a cauldron burnout, the coolant enters the melt and an explosion of the furnace may occur. In this case, a capillary-porous cooling system can be effective; it contains a very small amount of liquid, is explosion-proof and has a high forcing and a heat transfer rate [1-3].

## 2. METHODOLOGY

Methods for cooling of high-temperature elements in metallurgy are known, cooling is carried out by technical water, when cold water passes through the cooled surface, taking away the heat.

---

<sup>1</sup> Professor Dr.Sc., AUPET, Republic of Kazakhstan, [aipet@aipet.kz](mailto:aipet@aipet.kz)

<sup>2</sup> PhD Student, AUPET, Republic of Kazakhstan, e-mail: [dnellya@mail.ru](mailto:dnellya@mail.ru), cell: +77019303750

<sup>3</sup> Professor, PhD, Ruse University, Bulgaria, e-mail: [iliev@enconservices.com](mailto:iliev@enconservices.com)

Small heating of water requires its high consumption and construction of powerful water intake devices, equipment for cleaning, pumping and cooling water in the case of a reverse water supply system. The salt content led to the deposition of sludge, scale and frequent burnout of the cooled elements. The low water temperature at the outlet excludes the possibility of utilizing the waste heat by water, although the heat transfer to one unit may amount to tens of MW.

The cooling system becomes expensive due to bulky cooling devices with recycled water supply or when cleaning it in the case of direct flow, in addition, it is necessary to take into account the electrical energy consumption for pumping water.

New capillary-porous cooling system operating in the field of mass and capillary forces is developed and investigated. In the porous structure, an underheated coolant is transported to a saturation temperature with a forced speed. This makes it possible to increase the forcing of heat loads, significantly expand the limits of their removal [1-3], and intensify heat transfer processes [4-8]. Studies of the heat transfer crisis were carried out with the help of holographic interferometry, the optical-polarization method (photoelasticity) [1], and the thermoelasticity method [2,3]. Intensification of heat transfer processes [4] was achieved due to control of thermal wave energy, boiling characteristics [5] and heat exchange parameters [6]. The experimental data were generalized using the theory of similarity, modeling and analogy of heat exchange phenomena [7]. This allowed us to calculate dependences to define the heat fluxes and thermal headings depending on the regime and structural parameters of the structure and heat exchange surface [8]. We have considered the possibility of using capillary-porous cooling systems for explosion-proof melting units.

As an example of capillary-porous systems for the cooling of melting aggregates for the purpose of their explosion safety [9] is shown on figure 1.

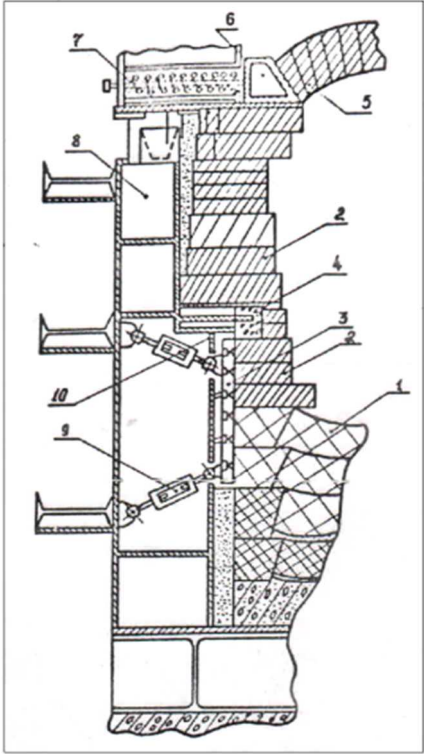

Figure 1: Installation of box-type caissons in the slag zone of melting furnace

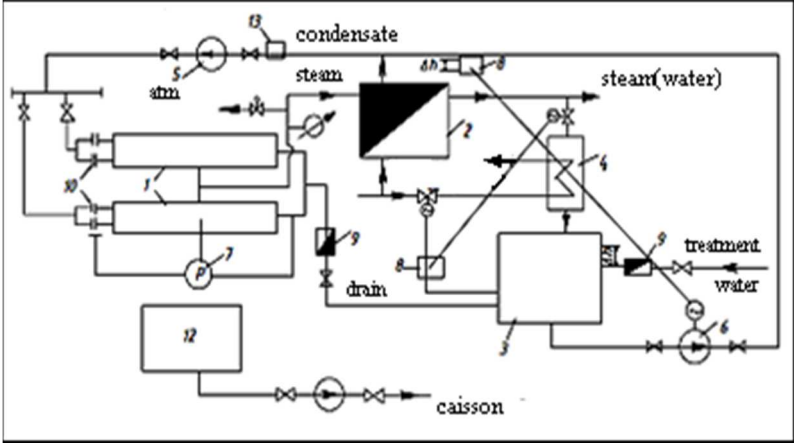

Figure 2: Installation of evaporation-condensation capillary-porous system for cooling of caissons

Figure 1 shows the installation of box-type caissons in the slag zone of melting furnace. Installation consists of: 1 - furnace bottom; 2 - wall; 3 - caisson; 4,10 - upper and lower shelves; 5 - arch; 6 - arch support beam; 7 - spring of the arch; 8 - framework rack; 9 - turnbuckles.

Figure 2 shows the installation of a capillary-porous system for cooling of elements (caissons): 1- cooled element; 2 - heat exchanger; 3 - feed supply tank; 4 - condensator of feed line; 5- condensate pump; 6 - feed pump; 7 - contact manometer; 8 - level controller; 9 - back flow valve; 10 - control valve; 11 - manometer; 12 - emergency repair tank; 13 - condensate cooler.

Engineering calculation of the operating and limiting characteristics of the capillary porous-cooling system can be carried out using a nomogram method. To construct the characteristics, previously geometrical parameters of the cooling system and porous structure is determined. Calculation is made on the basis of a ratio for thermal power

$$Q = \frac{\frac{T_w^{EV} - T_w^C}{1} + \frac{1}{\alpha_{EV} F_{EV}}}{\alpha_C F_C}, W. \quad (1)$$

The value of the heat transfer coefficient of the evaporator  $\alpha_{EV}$  is determined by the criterion equation obtained by us [7] or by the calculated dependences [3,6,8]. Setting the temperature of the wall in the condensator  $T_w^C = \text{const}$  for a number of vapor temperatures  $T_V$ , the necessary physical parameters of the liquid in the condensator are determined and the graph of  $\alpha_C = f(T_V)$  is constructed. From formula (2) the corresponding values of  $Q$  are determined for a number of values of  $T_V$

$$Q = \alpha_C F_C (T_V - T_L^C), W, \quad (2)$$

where  $T_L^C = 0,5(T_V + T_w^L)$ .

Setting the several values of temperature  $T_w^{EV}$ , the parameters of the liquid in the evaporator at the selected vapor temperature are determined and the graphs for  $\alpha_{EV} = f(T_w^{EV})$  are plotted and defined by the above equations and formula

$$\alpha_{EV} = \frac{Q}{(T_w^{EV} - T_V) F_{EV}}, W / m^2 K. \quad (3)$$

The intersection point of the curves gives the required temperature  $T_w^{EV}$ . So, the graticule of equidistant lines in the plane of  $Q = f(T_w^{EV})$  for different values of  $T_w^C$ , and it is necessary to take into account the heat transfer capabilities limited by the crisis phenomena [2,3].

For constructing the nomogram it is also necessary to know the heat exchange laws of the cooling system with the environment ( $\alpha_C^B = \text{const}$ ). For this purpose, for example, heat exchange coefficients with the external environment are set, or the conditions of creation of environmental temperature ( $T_{ENV} = \text{const}$ ) are accepted



$$Q = \alpha_C^B F_C (T_w^C - T_{ENV}), W. \quad (4)$$

Then to each value of  $Q$  (or  $T_w^C$ ) there corresponds a certain value  $T_w^C$  (or  $Q$ ). Consequently, by changing the external conditions of heat exchange with the surrounding environment, it is possible to regulate  $T_w^{EV}$  for a given heat release. In case that the wall temperature of the cooled element is set, it is necessary to specify a number of values of the Reynolds criterion ( $Re$ ), by which the values of the Stanton numbers are calculated and, after determining the value of  $\alpha_{EV}$ , a temperature  $T_w^{EV}$  is corrected. If the wall temperature exceeds the specified value, it is necessary to reduce the value of  $Re$  and, consequently, the heat load to be removed.

### 3. CONCLUSION

Thus, based on the fundamental research of the thermal and hydraulic heat transfer characteristics carried out on the models and experiment, the required information was obtained for the development, design, engineering calculation and operation of capillary-porous systems in various thermal power plants and metallurgical production.

The further development of highly efficient devices with porous structures makes it possible to convert energy production into environmentally friendly ones, improve labor protection conditions, significantly save natural resources, intensify processes in alternative sources, protect air, water and soil from pollution, including "thermal", to solve methodological problems and long-term problems of generation, transport and accumulation of energy.

### References

- [1] Polyayev V.M., Genbach A.N., Genbach A.A., *An experimental study of thermal stress in porous materials by methods of holography and photoelasticity*, Experimental thermal and fluid science, avenue of the Americas, New-York, V. 5, № 6, pp. 697-702, November 1992.
- [2] Genbach A.A., Burmistrov A.V., *Investigation of the thermal condition of the cylinders of steam turbines*, Industry of Kazakhstan, № 2 (65), pp. 91-93, 2011.
- [3] Polyayev V. M., Genbach A.N., Genbach A.A., *A limit condition of a surface at thermal influence*, Teplofizika vysokikh temperatur (TVT), V.29, No. 5, pp.923-934, 1991.
- [4] Polyayev V.M., Genbach A.A., *Control of Heat Transfer in a Porous Cooling System*. Second world conference on experimental heat transfer, fluid mechanics and thermodynamics, Dubrovnik, Yugoslavia, pp. 639-644, 23-28 June, 1991.
- [5] Polyayev V. M . Genbach A. A., *Management of internal characteristics of boiling in porous system*, Cryogenic equipment and conditioning: Collection of works of MGTU, Moscow, pp. 224-237, 1991.
- [6] Polyayev V.M., Genbach A.A. *Upravlenie teploobmenom v poristyh strukturah*, Izvestija Rossijskoj akademii nauk, Energetika i transport, V. 38, №6, pp. 105-110, 1992.
- [7] Polyayev V.M., Genbach A.A., *Heat transfer in a porous system operating under the joint action of capillary and gravitational forces*, Teploenergetika, № 7, pp. 55-58, 1993.
- [8] Poliaev V.M., Genbach A.A., *Limiting thermal loads in porous structures*, Izvestiya vuzov. Aviatsionnaya tekhnika, №.1.-pp. 33-37, 1991.
- [9] Genbach A.A., Jamankulova N.O., Bekalay N.K., *Poisk effektivnyh sistem ohlzhdeniya dlya vzryvobezopasnyh plavil'nyh agregatov*, Vestnik KazNITU, №1(119), pp 230-234, 2017.

# INVESTIGATION OF POROUS COVERAGE IN COOLING SYSTEMS FOR TURBINE EQUIPMENT ELEMENTS

Alexander A. Genbach<sup>1</sup>, David Yu. Bondartsev<sup>2</sup>-Almaty University of Power Engineering and Telecommunications, Department of Heat Engineering Installations,  
Iliya K. Iliiev<sup>3</sup>-University of Ruse, Department of Thermotechnics, Hydraulics and Ecology

## ABSTRACT

The mechanism of destruction of metal vaporizing surfaces and poorly heat-conducting coatings of low porosity made of natural mineral media (granite) has been described on the basis of the problem of thermoelasticity and experimental data. Thermal flow dependences on time of their action and depth of penetration of temperature perturbations were identified on the basis of analogy. Capillary - porous systems have high intensity, high heat transport ability, reliability, compactness. The results of calculations and experiment showed that the maximum thickness of the particles that detach under the influence of compression forces for granite coatings is  $(0,25\div 0,3) \times 10^{-2}$  m. Sections of compression curves that determine the detachment of particles with dimensions of more than  $0,3 \times 10^{-2}$  m for large thermal flows and short feed times, are screened by the melting curve, and in the case of small thermal flows and time intervals - the expansion curve. The studies are aimed at creation of porous coatings in cooling systems from well - and poorly conductive materials.

## 1. INTRODUCTION

Successful use of capillary-porous materials in engineering attracted many researchers and inventors to create different devices on their basis. The intensity of heat-eliminating systems and the forcing of processes taking place therein increased [1-3]. In addition to cooling systems, the use of porous materials allowed the creation of units which addressed the problems of explosion safety, labor protection and durability [4,6]. This was facilitated by the ability to control evaporation processes due to excess fluid in pores and capillary structures, formed by the combined action of capillary and mass forces [7-9].

In thermal power plants (TPPs), capillary-porous materials are used to cool highly-forced detonation burner units [3], to create steam coolers in steam boilers [9], oil coolers that prevent oil from entering cooling water and water from entering the bearing system [10] and labyrinth seals [11], and are used in other devices [10]. The main areas of practical application of capillary-porous systems are presented in [3,5,8-11].

Equipment and technological processes in the energy sector should be introduced from the ecological and economic positions primarily. The proposed development of capillary-porous systems will facilitate the implementation of processes, significantly improving and preserving the natural environment.

The main advantages of capillary-porous systems include high intensity, high heat transport ability, reliability, compactness, simplicity in manufacture and operation. These systems improve operational and technological performance and have low capital and operating costs. Based on the study of capillary-porous systems, new technical solutions have been developed to improve the performance characteristics of the thermal power plant in relation to the powerful power units of combined heat and power plants.

---

<sup>1</sup> Professor DSc, AUES, Almaty, Kazakhstan, [katerina-1@rambler.ru](mailto:katerina-1@rambler.ru)

<sup>2</sup> PhD Student, AUES, Almaty, Kazakhstan, [d.bondartsev@saem.kz](mailto:d.bondartsev@saem.kz), cell phone: +77015323661

<sup>3</sup> Professor, PhD, Ruse University, Ruse, Bulgaria, e-mail: [iiliev@enconservices.com](mailto:iiliev@enconservices.com), cell phone: +359 887306898

The authors of [12] carry out a comparative analysis of methods for calculating the heat transfer, based on the water boiling with underheating in vertical channels, and they consider that the hot spot corrosion of fuel element claddings of nuclear reactor fuel elements is similar to the capillary-porous structure [13,14]. However, no studies of heat transfer through a regular structured surface have been carried out.

According to the authors' opinion [15,16], surface boiling on porous surfaces can influence the development of corrosion due to the erosive action on the heat exchange surface, when the bubbles of steam fall in an underheated liquid. Therefore, it is required to investigate the evaporation of liquid in capillary-porous structures in the field of capillary and mass forces, taking into account the velocity and underheating, which are formed by excess fluid.

An estimated intensity of heat transfer for liquid boiling in a large volume and thin films on a smooth surface showed equal possibilities [12-14] at high thermal flow and higher heat transfer parameters than that in systems with a capillary-porous coating [15-16]. It is required to carry out investigations of the heat transfer capabilities of capillary-porous coatings operating in the field of capillary and mass forces, and to establish ultimate (critical) load values leading to the destruction of the heating surfaces.

The performed researches make it possible to give recommendations on the selection of the heating-and-cooling medium, take into account the type of its circulation, determine the geometry and material of apparatuses and heat exchange intensifiers, taking into account the conditions and orientations of the system operation under pressure or underpressure, the energy supply and type and the system orientation. Generalization of the experimental results and calculation procedure for heat and mass transfer in capillary-porous systems in accordance with, are presented in [17-21].

The investigation of various factors affecting the heat transfer in the structures show that the critical states of the heating surface are of particular interest, when the system is capable of carrying the maximum flows of energy and substance. In this case, however, the values of thermal flows and thermal stresses are required to be known in order to ensure a reliable long-term operation of the unit. Consequently, the maximum energy and substance transfer can be obtained for the following conditions: a pure liquid circulating in a forced scheme in closed elliptical heat exchangers under pressure in perforated and profiled heating surfaces made of stainless steel is used. The system operates with an excessed fluid, and the presence of mass forces ensures the forced flow of the heating-and-cooling medium with underheating. Energy is supplied to the vertical surface along the perimeter, with a supersonic high-temperature pulsating rotating torch [1,3,11,19].

## **2. AN EXPERIMENTAL METHOD**

Experimental units allowing to investigate the following integral characteristics of heat transfer have been developed: ultimate thermal flows ( $q$ ), up to critical ones; liquid ( $m_l$ ) and vapor ( $m_v$ ) flow rates; distribution of the temperature field along the height and the length of the heat exchange surface. Studies are carried out in a capillary-porous cooling system which can operate on the principle of a closed evaporative-condensation design, or to be open. Various heat exchange conditions are studied, including: method of the coolant supply; the extent of tightness of the capillary-porous structure; ability to feed up the micro-arterial structure along the height of the heat exchange surface; orientation of the surface relative to gravitational forces; geometry: flat, tubular and curved cooling surfaces; influence of pressure up to manifestations of crisis with wall burning.

To study the mechanism of heat transfer, holography methods and the generalization of similar and analogous phenomena are used [1,3,11,20,21]. The heat exchange is controlled using the elliptical systems, by the combined action of capillary and mass forces [1,3].

The study of heat transfer is of a practical nature. It is intended for the creation of various thermal power plants: steam attenuators of steam boilers, porous coatings of poorly heat-conducting material, seals in steam turbines and a number of other power plants [1,3,7,10,19].

Figure 1 shows a cross section of a flat experimental unit with a perforated pressure plate 3 (Fig. 2), tubular arteries 4 and a capillary-porous structure 2.

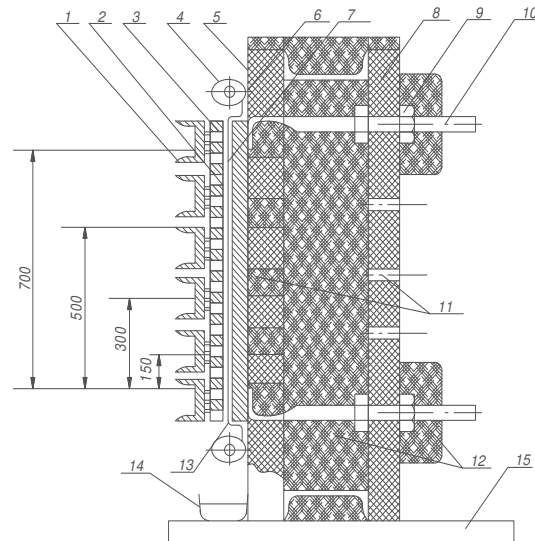

**Figure 1.** Cross section of a flat experimental unit: 1 – pressing bar, 2 – capillary-porous structure, 3 – perforated pressure plate, 4 – tubular artery, 5 – asbestos cement plate, 6 – heater, 7 – insulation, 8 – plate, 9 – clamping nut, 10 – electrode, 11 – windows, 12 – heat insulation, 13 – coolable wall, 14 – collector, 15 – stand.

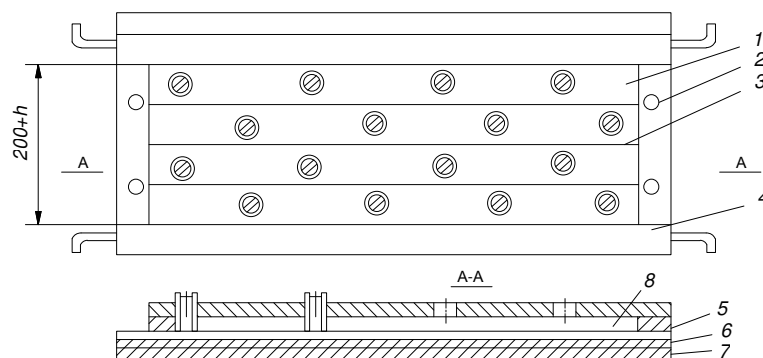

**Figure 2.** Pressure scheme for the capillary-porous structure: 1 – plates, 2 – pressure screws, 3 – steam slots, 4 – fluid supply, 5 – pressure perforated plate, 6 – capillary-porous structure, 7 – heated wall, 8 – microartery.

The maximum possible error:

A)  $\pm 0,6\%$ , when measuring current;  $\pm 1\%$ , when voltage is dropped; power is  $\pm 1,6\%$ ,

B)  $\pm 3\%$ , when determining the liquid flow rate, using a rate-of-flow meter.

The imbalance of the current-supplied heat and the heat led to circulation and excess water, taking into account heat losses through the insulation, did not exceed  $\pm 12\%$ , and  $\pm$

11% through circulating water. The discrepancy between the material balance between the flow rate of the cooling liquid and drainage and condensate flow is no more than  $\pm 10\%$ . The measurement procedure and the processing of experimental data were published in [2,4].

To study the boiling crisis, we also assembled the units made in the form of a rocket-type flame-jet burner. The scheme of the experimental unit and the experimental conditions are presented in [3]. Ignition chambers and supersonic nozzles were cooled using a capillary-porous and water system. The thermoreactive burner was also used to study the critical state of capillary-porous coatings made of natural mineral media (granite, quartz and teschenite coatings). The thermal effect was realized by a supersonic (up to 2000 m/s) high-temperature (up to 2500°C) pulsating torch.

### 3. MODEL OF A CAPILLARY-POROUS

To determine the critical thermal flows and stresses, the thermoelasticity problem [3,9,10] is solved under the secondary limiting conditions for the one-dimensional equation of nonstationary heat conductivity.

Let's consider a plate with the thickness of  $2h$ . The constant ultimate thermal flow  $q$  is supplied to the surface  $z = +h$ , starting from the timepoint  $t = 0$ . The bottom surface  $z = -h$  and the plate side edges are thermally insulated.

Thermal conductivity equation with limiting and initial conditions can be written in the form:

$$\begin{aligned} \alpha_w \frac{\partial^2 T}{\partial z^2} &= \frac{\partial T}{\partial \tau}, \quad T = 0, \quad \tau < 0; \\ \lambda_w \frac{\partial T}{\partial z} &= q, \quad z = +h; \\ \lambda_w \frac{\partial T}{\partial z} &= 0, \quad z = -h. \end{aligned} \quad (1)$$

The temperature distribution along the thickness depends on the thermophysical properties of the material, the thermal flow value and the feeding time:

$$T\left(\frac{z}{h}; \tau\right) = q \left\{ \frac{M}{2(c\lambda\rho)_w} \tau + \frac{3z^2 + \frac{6z}{h} - 1}{12M} - \frac{4}{\pi^2 M} \sum_{n=1}^{\infty} \frac{(-1)^n}{n^2} \exp\left[-n^2 \frac{\pi^2 M^2}{4(c\lambda\rho)_w} \tau\right] \cos\left[\frac{n\pi}{2} \left(\frac{z}{h} + 1\right)\right] \right\}, \quad (2)$$

where  $M = \frac{\lambda_w}{h}$ ;  $n$  – positive numbers.

Using the known temperature distribution in the plate, we can find the thermal tension and compression stresses arising at a certain time  $t$  at various depths from the surface  $\delta_i = (h = z_i)$  for a given value of the thermal flow  $q$ , since the plate with a variable temperature is in the plain stress condition.

$$\sigma_{xx} = \sigma_{yy} = -\frac{\alpha E}{(1-\nu)} T\left(\frac{z}{h}; \tau\right) + \frac{1}{(1-\nu)2h} \int_{-h}^{+h} \alpha 2' E T\left(\frac{z}{h}; \tau\right) dz, \quad (3)$$

where the first term is the component of the compression stress, and the second term is the tension stress.

#### 3.1. SOLUTION TO THE EQUATION (1).

If we are given the limiting values of tension and compression stresses for the rock (porous coatings from the natural mineral medium) and the metal, we obtain the dependence of the thermal flow required for destruction on the time of delivery and the depth of

penetration. In addition, equating the temperatures on the plate surface to the rock and metal melting temperature, we find the values of the ultimate thermal flows necessary for melting the surface layer for a different period of their action:

surface melting:

$$q_1 = \frac{T_f}{\left\{ \frac{M}{2(c\lambda\rho)_w} \tau + \frac{2}{3M} - \frac{4}{\pi^2 M} \sum_{n=1}^{\infty} \frac{(-1)^n}{n^2} \exp\left[-n^2 \frac{\pi^2 M^2}{4(c\lambda\rho)_w} \tau\right] \cos n\pi \right\}}; \quad (4)$$

development of limiting compression stresses:

$$q_2 = \frac{\frac{(1-\nu)\sigma_{ut}}{\alpha E}}{\frac{M}{2(c\lambda\rho)_w} \tau + \frac{3z^2 + \frac{6z}{h} - 1}{12M} - \frac{4}{\pi^2 M} \sum_{n=1}^{\infty} \frac{(-1)^n}{n^2} \exp\left[-n^2 \frac{\pi^2 M^2}{4(c\lambda\rho)_w} \tau\right] \left[\cos \frac{n\pi}{2} \left(\frac{z}{h} + 1\right)\right]}; \quad (5)$$

creating ultimate tension stresses:

$$q_3 = \frac{\frac{(1-\nu)\sigma_{ut}}{\alpha E}}{\frac{M}{2(c\lambda\rho)_w} \tau}. \quad (6)$$

The dependences of  $q_1$ ,  $q_2$ ,  $q_3$  on time  $\tau$  for fixed particle size  $\delta$  values for the coating, or the penetration depth of temperature perturbations for the metal, were calculated on a PC with respect to a plate made of quartz, granite and metal (copper and stainless steel).

#### 4. CONCLUSIONS

A scientific method for studying and creating of capillary-porous cooling systems and coatings for various heat and mass transfer conditions in power equipment elements has been developed.

Based on the conducted studies in case of exposure with a torch of a kerosene-oxygen burner of porous coating within working area, we have up to  $4 \times 10^7$  W/m<sup>2</sup> corresponded to  $q$  of coatings of  $0,4 \times 10^7$  W/m<sup>2</sup>. The metals destruction mechanism is fundamentally different from the rocks coatings destruction mechanism. In the future, the studies of other porous natural materials are required.

#### References

- [1] Polyayev, Genbach A.A., Methods of Monitoring Energy Processes, Experimental Thermal and Fluid Science, International of Thermodynamics. Experimental Heat Transfer, and Fluid Mechanics. *Avenue of the Americas*, New York, USA, 1995, Vol. 10, pp. 273-286
- [2] Polyayev, V.M., Genbach A.A., Heat Transfer in a Porous System in the Presence of Both Capillary and Gravity Forces, *Thermal Engineering*, 40 (1993), 7, pp. 551-554
- [3] Polyayev, V.M. Genbach A.A., A Limit Condition of a Surface at Thermal Influence (in Russian), *Teplofizika Vysokikh Temperatur*, 29 (1991), 5, pp. 923-934
- [4] Polyayev, V.M., Genbach A.A., Control of Heat Transfer in a Porous Cooling System. Proceedings, 2<sup>nd</sup> World Conference on Experimental Heat Transfer, Fluid Mechanics and Thermodynamics, *Dubrovnik*, Yugoslavia, 1991, pp. 639-644

- [5] Polyayev, V.M., Genbach A.A., Processec in the Porous Elliptic Heat Exchanger (in Russian), *Isvestiya Vuzov, Mashinostroyeniye*, (1991), 4-6, pp. 73-77
- [6] Genbach A.A., Bakhytzhanov I.B., Protection Against Earthquakes TPP Bases with the Help of Porous Geo Screens (in Russian), *Poisk, MES of RK*, (2012), 1, pp. 289-298
- [7] Genbach A.A., Danilchenko I., Porous Desuperheater Steam Boilers (in Russian), *Promyshlennost Kazakhstana*, 70 (2012), 1, pp. 72-75
- [8] Genbach A.A., Olzhabayeva K.S., Visualization of Thermal Impact on Porous Material in Thermal Energy Installations of Power Plants, *Bulletin of the National RK Engineering Academy*, 45 (2012), 3, pp. 63-67
- [9] Genbach A.A., Islamov F.A., Research of the Nozzle Fillets in Electrical Installations (in Russian), *Vestnik KazNTU*, 97 (2013), 3, pp. 245-248
- [10] Genbach A.A., Islamov F.A., Modeling Process Grazing Turbine (in Russian), *Vestnik KazNTU*, 100, (2013), 6, pp. 235-240
- [11] Polyayev, V.M., Genbach A.A., Control of Heat Transfer in Porous Structures (in Russian), Proceedings, Russian Academy of Sciences, *Power Engineering and Transport*, 38 (1992), 6, pp. 105-110
- [12] Jamialahmadi M., et al., Experimental and Theoretical Studies on Subcooled Flow Boiling of Pure Liquids and Multicomponent Mixtures, *Intern. J Heat Mass Transfer*. 51 (2008), 9-10, pp. 2482-2493
- [13] Ose Y., Kunugi T., Numerical Study on Subcooled Pool Boiling, *Progr. In Nucl. Sci. and Technology* 2, (2011), pp. 125-129
- [14] Krepper E., et al., CFD Modeling Subcooled Boiling-Concept, Validation and Application to Fuel Assembly Design, *Nucl. Eng. and Design*, 237 (2007), 7, pp. 716-731
- [15] Ovsyanik A.V., Modelling of Processes of Heat Exchange at Boiling Liquids (in Russian), *Gomel State Technical University named after P.O., Sukhoy, Gomel*, Belarus, 2012
- [16] Alekseik, O.S., Kravets V.Yu., Physical Model of Boiling on Porous Structure in the Limited Space, *Eastern-European Journal of Enterprise Technologies*, 64 (2013), 4/8, pp. 26-31
- [17] Polyayev, V.M., Genbach A.A., Analysis of Laws for Friction and Heat Exchange in the Porous Structure (in Russian), *Bulletin of MGTU, Mechanical Engineering Series*, (1991), 4, pp. 86-96
- [18] Polyayev, V.M., Genbach A.A., The Influence of Pressure on the Intensity of Heat Transfer in a Porous System (in Russian), *Isvestiya Vuzov, Mashinostroyeniye*, (1992), 4-6, pp. 68-72
- [19] Polyayev, V.M., Genbach A.A., Field of Application of Porous System (in Russian), *Isvestiya Vuzov, Energetika*, (1991), 12, pp. 97-101
- [20] Genbach A.A., Jamankylova N.O., Bakic Vukman V. The processes of Vaporization in the Porous Structures Working With The Excess of Liquid, *Thermal Science: Year 2017*, Vol 21, №1A, pp. 363-373. DOI:10.2298/TSCI160326313G
- [21] Genbach A.A., Olzhabayeva K.S., Iliev I.K., Boiling Process in oil Coolers on Porous Elements, *Thermal Science: Year 2016*, Vol. 20. № 5, pp. 1777-1789. DOI:10.2298/TSCI150602166G

# HEATING WITH HEAT PIPES

Alexander A. Genbach<sup>1</sup>, Karlygash Olzhabayeva<sup>2</sup>, Kudajbergen Shokolakov<sup>3</sup>-  
Almaty University of Power Engineering and Telecommunications,  
Department of Heat Engineering Installations,  
Iliya K. Iliev<sup>4</sup>-University of Ruse, Department of Thermotechnics, Hydraulics and Ecology

## ABSTRACT

A heating device based on a heat pipe has been designed for heating viscous fluids and heating of production premises in power stations. The appliance provides fire and electrical safety, heat transfer intensification, forcing of heat exchange, reduces the metal elasticity and the mass of the appliance. The capillary-porous structure was with dimensions of 0.4 x 0.55 and was determined experimentally. It is established that for a heat output of 4 kW a pipe of diameter  $d = 13$  mm is needed; the length of the evaporation zone is  $l_{\text{evp}} = 0,1$  m; and of the condenser  $l_{\text{cond}} = 1.7$  m, where the finned coefficient is 5.

## 1. INTRODUCTION

The heating device can be used in power plants for heating viscous liquids, for example, turbine oil, fuel oil for burning in steam and hot water boilers.

The device is also useful for the manufacture of construction and installation works on power plants for heating industrial and domestic premises, such as structures for people, small buildings, cabinets for dressing, heating room, rest, food, labor protection offices, red corners, medical stations, inventory domestic facilities, dressing rooms, mobile control room.

There are known heating systems for industrial and domestic premises, individual workplaces where it is permitted to use heating appliances or electric appliances with infrared radiators operating periodically.

The disadvantage of such heating systems is the possibility of electric shock hazard (electrical hazard) and high fire hazard. There is a known heating system for a passenger vehicle (author's certificate of the USSR No. 742216, class B6ID27 / 00, 1980) containing a heating object, primarily a locomotive driver's cab, a thermal energy source in the form of flue gas heat with evaporation and condensation zones located at an angle to the source of thermal energy, the handle, which moves the camera-accumulator.

However, in this form, the heating system can not be used in production and domestic premises for the manufacture of construction and installation works, since these premises do not have propulsion systems, waste gases, which are used as a heat source for evaporation of the heat transfer in the heat pipe.

In addition, to remove heat in the cabin installation forced ventilation system, which requires additional expenditure of electrical energy to power the fan motor. In general, the republican economy is very large for ventilation, accounting for about 10% of all electricity production, and therefore the issue of economy is topical. Possible breakthrough of hot exhaust gases with a temperature of 400..500<sup>0</sup>C is associated with driver's damage and fire contamination.

---

<sup>1</sup> Professor DSc, AUES, Almaty, Kazakhstan, [katerina-1@rambler.ru](mailto:katerina-1@rambler.ru)

<sup>2</sup> PhD Student, AUES, Almaty, Kazakhstan, [d.bondartsev@saem.kz](mailto:d.bondartsev@saem.kz), cell phone: +77015323661

<sup>3</sup> PhD Student, AUES, Kazakhstan, [kudash@bk.ru](mailto:kudash@bk.ru)

<sup>4</sup> Professor, PhD, Ruse University, Ruse, Bulgaria, e-mail: [iliev@enconservices.com](mailto:iliev@enconservices.com), cell phone: +359 887306898



To ensure fire and electrical safety and intensification of heat transfer during heating of viscous fluids and industrial - domestic premises in the conditions of construction and installation works. The heater is made in the form of a heat pipe, located at an angle to the source of thermal energy. It contains zones of evaporation and condensation, a source of thermal energy that is located in the heat transfer of the evaporation zone of the heat pipe and is fixed to its body, and the perforated shell surrounding the condensation zone has flexible cables located along the perimeter of the pipe with high-conductivity branches, the area of the shell holes, located below the axis of symmetry of the heat pipe, exceeds their area on the surface of the shell, located above the axis of symmetry.

In addition, the zone of evaporation of the heat pipe, filled with a heat transfer, contains thermal insulation, and for regions with a low outside air temperature, the coolant is a liquid with a negative freezing temperature, for example, an aqueous solution of sodium chloride, and the capillary-porous structure of the heat pipe is made of large cells of a grid lumen, for example, from two layers of a grid of the form 0,4x0,55 [1].

## 2. AN EXPERIMENTAL METHOD

The condensation zone 14 (Fig. 1, a) of the heat pipe 4, installed at an angle to the source of thermal energy, which is an electric heater 2, placed in the heat transfer 9, on the inner surface contains a porous structure 5 of the form 0.4x0.55. The appearance of the porous structure and its dimensions are determined experimentally.

The heat generated by the electric heater 2 in the evaporation zone 10 is expended on vaporization of the heat transfer 9. The flow of the generated vapor II rushes to the area of the condensation zone 14 cooled by the airflow 12 of room I. The vapor stream 15 condenses heat to the wall of the heat pipe 4 and the condensate of the condensed vapor 13 returns to the evaporation zone 10 of the heat pipe 4 again.

The heat of condensation is transmitted with high intensity through the porous structure 5 and the wall of the heat pipe 4 by a flexible cable 6 with high-conductivity branches 7 covered by a perforated shell 8. There is a mixed air flow around the condensation zone 14: a part of the air, due to the temperature difference, starts to flow inside the channel formed by the perforated shell 8, longitudinally flowing high-conductor branches; another, a smaller part of the air, due to the vertical thrust, will circulate between the branches and flow around them transversely. The presence of a flexible cable further turbulizes the boundary layer due to its vibration, which contributes to the destruction of stagnant air zones and a large area of openings in the shell 8 located below the symmetry of the heat pipe 4 will improve the natural draft of air through the high-heat holes.

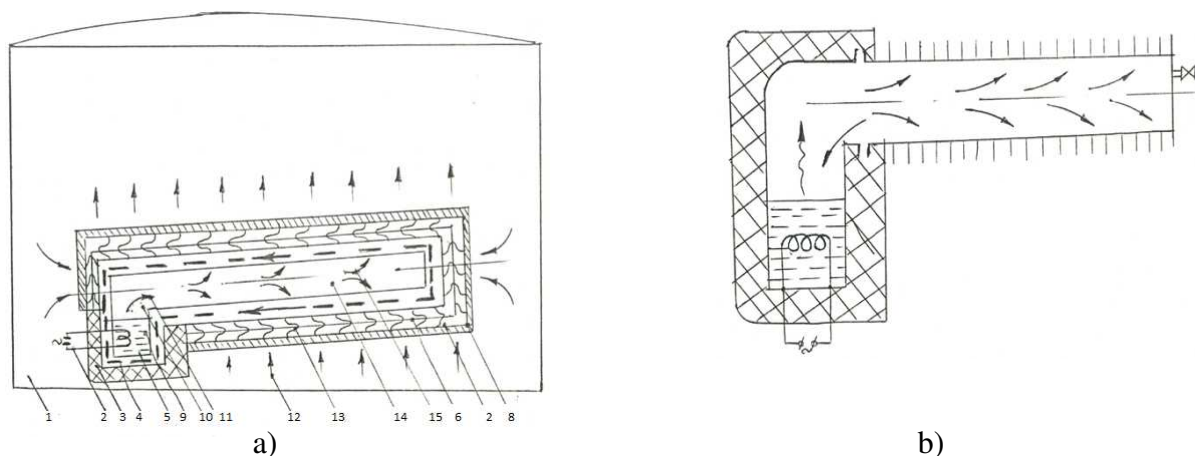

Figure 1. Heating device: a) general form b) scheme of installation

The thermal insulation 3, covering the evaporation zone 10 with the heat transfer 9, allows at ambient temperatures to protect the heat transfer 9 from freezing within a few days, and in the case of very low temperatures and prolonged absence of workers, it is recommended to use a liquid with a negative freezing point as the heat transfer 9, for example, an aqueous solution of sodium chloride.

The economic effect takes place due to reduction of fire danger, reduction of material consumption by 10% and installation weight - by 15%, reduction of capital costs for heating system manufacture, simplification of device operation.

Social effect is achieved by eliminating people's electric shock and damage caused by fires, which improves working conditions of workers, increases their productivity and quality of work.

Fire and explosion safety is achieved due to the fact that the electric heater is located in the coolant inside the evaporation zone of the heat pipe, therefore the temperature of the heat-releasing elements (the turns of the wire) will be low [6], several degrees above the temperature of the boiling heat-transfer agent, thus eliminating the fire hazard of the heater.

Since the turns of the wire are in a closed volume of the evaporation zone, and the reliability and tightness of the electrical insulation has reached a very high value, as can be judged by the example of electric kettles, frying pans and other domestic devices, therefore excludes the locking of the electric heater wire between each other and the case.

As shown by the experimental studies of the authors, the selected porous structure has a high heat transfer potential, several times larger than the corresponding ones, requires the least cost for the production of a heat pipe, has several times less hydraulic resistance than existing ones. The selected insulation prevents the water from freezing in the evaporation zone of the heat pipe at an outside temperature of (-20°C) for 2.2 days, with very severe frost (-40°C) - 1.57 days, when used with a negative freezing temperature, for example, an aqueous solution of sodium chloride. The absence of a fan saves energy, excluding from the heating system the handle that moves the camera-drive, simplifies the operation of the device. We present experimental studies on the determination of the type of a capillary-porous structure. In contrast to the traditional capillary structures of heat pipes [4,5], which are recruited from fine-meshed meshes, a capillary-porous structure of two mesh layers with a large cell size of 0.4x0.55 is proposed, that is, two successively established layers with a cell width  $0,4 \cdot 10^{-3}$  and  $0,55 \cdot 10^{-3}$  m. This structure allows, firstly, to perform a more forced mode depending on the minimum hydraulic resistance (Table 1) and, secondly, due to large cells. Capital and operating costs for its manufacture and maintenance.

### **3. EXPERIMENTAL DATA**

As seen from Table 1, the largest heat transfer ability has a porous structure 0,4x0,55. Physically, this can be explained by the fact that due to the combined action of the capillary and the mass forces in the porous structure creates a stable biphasic pulsing layer and large size grid cells contribute to facilitate the removal of accumulating steam conglomerates than is the case in the capillary - a porous structure in which the pore size even less, comes in 4 times less. A similar phenomenon of crisis is also in thin-film evaporators, that is, on a smooth surface.

Table 1. Experimental data on heat transfer capabilities and wall overheating of various capillary-porous structures of water heat pipes

Type of capillary-porous structure	Heat transfer capability of heat pipe, $\times 10^4, W / m^2$					
	5	10	20	40	60	80
0,08x0,14x1	17	21	35	46	57	burnout of the wall
0,14x0,14x0,14	17	25	40	47	53	“-“
0,4x0,55	19	30	42	57	60	65
Powder and fibrous structures	7	12	burnout of the wall			
Thin-film evaporators (without capillary-porous structure)	10	15	burnout of the wall			

For structures of sintered powders and cermets, the phenomenon of crisis is explained by the fact that the emerging vapor bubbles clog small pores, stopping access to fresh portions of liquid to the cooled wall. The boiling crisis occurs when heat flows  $\approx 2 \cdot 10^5 W / m^2$ .

With a specific heat flux  $\approx 1 \cdot 10^5 W / m^2$  and total electric heater power  $N = 4000 W$ ,

the surface of the evaporation zone will be  $F_{\text{н}} = \frac{4000}{1 \cdot 10^5} = 4 \cdot 10^{-2} m^2$ , assuming the outer diameter of the pipe  $0,13 m$ , determine the length of the evaporation zone:

$$l_u = \frac{F, u}{\pi d n a p} = \frac{4 \cdot 10^{-2}}{3,14 \cdot 0,13} = 0,0979 m. \text{ Finally, the length of the evaporation zone is determined}$$

from the conveniences of mounting standard electric heaters.

Coefficient of heat transfer from the condensing steam to the inner wall of pipes according to the criterion equation of heat transfer.

Regarding the heat transfer coefficient  $d_k$ . We have

$$\alpha = \left[ G_* C p_* \cdot 3,5 \cdot 10^3 \text{Pr}_*^{1,3} \left( \frac{r}{C p_* q} \right)^{0,4} \text{Re}^{0,9} N_x^{0,48} \cdot \left( \frac{F_{nap}}{\varepsilon F_\phi} \right)^{-1,17} \left( \frac{F_r^2}{K F_\phi} \right)^{-0,59} \right]^{-1,67} \quad (1)$$

Stanton number  $St = d_k / G_* C p_*$

$G_*$  – specific fluid flow

$$G_* = \frac{qF_{nap}}{r\varepsilon F_\phi} = \frac{1 \cdot 10^5 \cdot 0,82}{2,3 \cdot 10^6 \cdot 0,29 \cdot 10^{-3}} = 122,9 \text{ kg / c} \cdot \text{m}^2. \quad (2)$$

$q = 1 \cdot 10^5 \frac{W}{m^2}$  – outer surface of condensation of heat pipe;

$F_{nap}$  – outer surface of condensation of heat pipe;  $F_{nap} = \pi d_{nap} L = \pi \cdot 0,13 \cdot 2 = 0,82 \text{ m}^2$ ;

$L = 2 \text{ m}$ : (we accept in advance);  $\varepsilon F_\phi$  – live section of the structure

$$\varepsilon F_\phi = \varepsilon \pi d_{nap} \delta_\phi = 0,7 \cdot \pi \cdot 0,13 \cdot 1,02 \cdot 10^{-3} = 0,29 \cdot 10^{-3} \text{ m}^2; \quad (3)$$

Complex

$$\left( \frac{r}{Cp_* q} \right)^{0,4} = \left( \frac{2,3 \cdot 10^6}{4,2 \cdot 10^3 \cdot 1 \cdot 10^5} \right)^{0,4} = 0,125 \quad (4)$$

Re– Reynolds criterion to steam.

$$Re = \frac{qR_{mp}}{r\mu_n} = \frac{1 \cdot 10^5 \cdot 0,13 \cdot 0,5}{2,4 \cdot 10^6 \cdot 12 \cdot 10^{-6}} = 235,5 \quad (5)$$

$R_{mp}$  – pipe radius ( $R_{mp} \approx R_{uez}$ )

$$Re^{0,9} = (235,5)^{0,9} = 136,4;$$

$Pr_*$  = Prandtl criterion;  $Pr_*^{1,3} = 1,75^{1,3} = 2,07$ ;

$N_p$  – pressure criterion, take working pressure in the pipe;

$P_s = 0,39 \text{ бар}$ , which corresponds to the saturation temperature  $75^0 \text{ C}$ . Then

$$N_p^{0,48} = \left( \frac{P_s R_{mp}}{\sigma} \right)^{0,48} = \left( \frac{0,39 \cdot 10^5 \cdot 0,13 \cdot 0,5}{0,063} \right)^{0,48} = 162,3 \quad (6)$$

Where  $\sigma$  – surface tension coefficient.

Geometric simplexes

$$\left( \frac{F_{nap}}{\varepsilon F_\phi} \right)^{-1,17} = \left( \frac{0,82}{0,29 \cdot 10^{-3}} \right)^{-1,17} = 9,16 \cdot 10^{-5} \quad (7)$$

$F_n$  – pipe cross-section

$$F_n = \pi R_{mp}^2 = \pi \cdot \left(\frac{0,13}{2}\right)^2 = 0,0133 \text{ m}^2 \quad (8)$$

$$\left(\frac{F_n}{KF_\phi}\right)^{-0,59} = \left(\frac{0,0133^2}{6,26 \cdot 10^{-10} \cdot 0,414 \cdot 10^{-3}}\right)^{-0,59} = 615 \cdot 10^{-6} \quad (9)$$

$$K = 4,305 \cdot 10^{-10} \left(\frac{b}{d}\right)^{0,5} = 4,305 \cdot 10^{-10} \left(\frac{0,475}{0,225}\right)^{0,5} = 6,26 \cdot 10^{-10} \text{ m}^2 \quad (10)$$

where b,d - hydraulic and average diameters of wire mesh structure 0,4x0,55 ( $b = 0,475 \cdot 10^{-3} \text{ m}$ ;  $\bar{d} = 0,225 \cdot 10^{-3} \text{ m}$ ).

$$\alpha_\kappa = \left[122,9 \cdot 4,2 \cdot 10^{-3} \cdot 3,5 \cdot 10^3 \cdot 2,07 \cdot 0,125 \cdot 136,4 \cdot 162,3 \cdot 9,16 \cdot 10^{-5} \cdot 6,15 \cdot 10^{-6}\right]^{1,66} = 8,74 \cdot 10^4 \text{ W/m}^2\text{K} \quad (11)$$

The thermophysical properties of water and steam adopted by [4]. Setting the finning coefficient of elastic ropes and calculating by the traditional formula the heat transfer coefficient by convection from the surface of the shell to air ( $2b = 4 \text{ Bm/m}^2\text{K}$ ), the heat transfer coefficient in the condensation zone is determined ( $K \approx 20 \text{ Bm/m}^2\text{K}$ ). Then, for a thermal power of 4 kW, a heat pipe with a diameter of 0.13 m, a length of the evaporation zone of 0.1 m and a condensation zone of 1.7 m are required.

#### 4. CONCLUSIONS

Thus, a heating device on a warm pipe provides fire safety, intensification of heat transfer, forcing heat exchange, reduces the material consumption and mass of the installation.

A capillary-porous structure of the 0.4 × 0.55 type is determined experimentally and provides a greater heat transfer capacity than the greenhouse and fibrous structures. For a thermal power of 4 kW, a heat pipe with a diameter of 0.13 m is required, the length of the evaporator zone is 0.1 m, the condensation zone is 1.7 m and with a finning coefficient of flexible cables equal to 5.

#### References

- [1] Genbach A.N., Genbach A.A., Tretyakova N.I. Heating device // *Patent USSR* №1557432. №14, 1990.
- [2] Genbach A.A., Genbach N.A., Genbach I.A., Genbach An.A. Influence of the material and the thickness of the porous structure on heat and mass transfer in heat exchangers of TPPs // *Power engineering telecommunications and higher education in modern conditions. – Proceedings of 3<sup>rd</sup> International scientific-technical conference – AUES. 2002. – 70-73 pp.*
- [3] Polyayev V.M., Genbach A.A. Heat transfer in a porous system operating under the combined action of capillary and gravitational forces // *Heat power engineering*, №7. – 1993. – 55-58 pp.
- [4] Dan P.D., Rei D.A. Heat pipes. – M.: *Energy*, 1973. – 272 pp.
- [5] Voronin V.G. and other. Low temperature heat pipes for aircrafts. – M.: *Mechanical engineering*, 1976. – 200 pp.
- [5] Daniela PANĂ, Ion V. ION, Marcel DRĂGAN, Metal heating furnace with flue gases condensation - thermoeconomic analysis, The Annals of "Dunarea De Jos" University Of Galati, Fascicle IX. Metallurgy and Materials Science No. 4 – 2014, p.10-13, ISSN 1453 – 083x, <http://www.sim.ugal.ro/Annals.htm>
- [6] GH. Lăzăroiu, L. Mihăescu, T. Prisecaru, I. Oprea, I. Pîșă, G. Negreanu, R. Indrieș, „Combustion of pitcoal-wood biomass brichettes, in a boiler test facility”, *Environmental Engineering and Management Journal*, “Gh. Asachi” Technical University of Iasi, Romania, September/October 2008, Vol.7, No.5, pp. 595-601, <http://omicron.ch.tuiasi.ro/EEMJ/>

# COMPARATIVE ANALYSIS OF THE EXISTING DUST COLLECTORS WITH THE DESIGNED CAPILLARY POROUS DUST COLLECTOR WITH CONTROLLED GEOMETRY OF MICRO-CHANNELS

Alexandr Genbach, Kudaibergen Shokolakov, Angel Terziev<sup>1</sup>

## ABSTRACT

This is a comparative analysis of the standard dust collectors with nozzle-free capillary porous devices with controlled geometry in a form of elastic composite materials joined with vibrator, which is operated in accordance with the kinematic diagram of the reciprocating motions. This device helps to increase hundred times a duration between regenerations, and reduce 1,5 times a consumption of foam generator, fully utilize acoustic energy by decreasing three times a specific acoustic power. Hydraulic and gas dynamic resistance will be decreased 1,5-2 times, and effectiveness of dust and gas collection will be 99,9 %.

The simplified design, reduced consumption of materials, minimized power consumption for air transfer, foam forming solution and steam generation are the reasons for reduced implementation costs of the proposed foam generators and dust collectors.

Generally, the aero hydrodynamic constructive diagrams of the proposed nozzle-free foam generators of air (steam) mechanical foam and dust-and-gas collectors on capillary porous structure meet the operational sanitary requirements, safety in operations of different industrial companies, and are considered reliable, easy-to- produce and maintain.

Study of the dust suppression and dust collection processes was implemented during the educational process at the faculty of "Heat & Power Units" at the Almaty University of Energy and Communications, at the Almaty Branch of MIRK Energo, as well as Trust Alma-AtaInzhstroï and Almaty Heat & Power Plant-2.

## 1. INTRODUCTION

Development of the foam capillary porous generators and dust-and-gas collectors of new type was derived from study of pure liquids boiled in the porous structures and managed by different physical fields: mass (gravity and pressure forces), capillary, vibration and wave (ultrasound) [1-5]. The different physical processes such as boiling, injection, suction (condensation), bubbling, foam generation, pseudo fluidization were summarized with a single criterial equation with accuracy  $\pm 20\%$  [2].

Foam generation and de-foaming processes, as well as collection of microscopic particles are available in the upgraded capillary porous structures (grids or partitions), whereas foam forming solution is sprayed with a nozzle-free foam generator, and either pure dusty air-gas-foam-steam mechanical flows were used for the bubble blowing energy or electric power of low voltage [3,5-12]. The internal features of multiphase flows, as well as bubble size, dispersion, their growth speed, density of cores, intensity of drop entrainment, frequency of silence and development, departure diameters, values of formation and time of their formation and destruction determine a stability of multiphase pulse boundary layer and control of different physical fields and constructive properties of devices [1-4, 7-9, 11-15].

A particular attention in comparative analysis is given to the foam nozzle-free capillary porous dust-and-gas collectors with elastic composite materials in which geometry of micro

---

<sup>1</sup> 8 Kliment Ohridski blvd., Sofia, Bulgaria, phone: +359 895 58 60 70; email: [aterziev@tu-sofia.bg](mailto:aterziev@tu-sofia.bg)

channels is controlled by vibrator which is operated in accordance with the kinematic diagram of the reciprocating motions [6].

Modern methods and devices used in dust suppression and dust collection with the help of air (steam)-mechanical foam [16-19], and designed nozzle-free generators of air mechanical foam and dust-and-gas collectors having a capillary porous structure are applicable to make their assessment and analysis.

The studies performed for the optimization of porous structure give information about the required sizes of vapor and gas bubbles where it is possible to achieve a maximum effectiveness of dust collection, dust suppression against fire fighting, as well as values of effective head. Also an issue about the efficiency of dust collection of minor fraction particles was solved in a presence of highly intensive condensation process of water enriched steam on surfaces with capillary porous coating. Type of capillary porous structure was determined, mode and geometric properties of the system, the respective engineering relations were provided [2, 3, 6-8, 12, 15].

## **2. DESCRIPTION OF THE CASE STUDY**

Generally, the proposed capillary porous structure of the aero-hydrodynamic constructive diagrams of nozzle-free foam generators of air (steam) mechanical foam and dust-and-gas collectors on capillary porous structure meet the operational sanitary requirements, safety in operations of different industrial companies, and are considered reliable, easy to manufacture and easy to operate and maintain.

Study of the dust suppression and dust collection processes was implemented during the educational process at the faculty of "Heat & Power Units" at the Almaty University of Energy and Communications, at the Almaty Branch of MIREK Energo, as well as Trust Alma-AtaInzhstroi and Almaty Heat & Power Plant-2.

Investment costs for the implementation of foam generators and dust collectors will be reduced because of the simplified design, reduced consumption of materials, minimized power consumption for air transfer, reduced amount of foam solution and steam generation. Besides consumption of foam forming solution is reduced, efficiency of devices due to the automatic reasonable correlation of components under different operational modes of dust cleaning equipment is increased. Social effect implies improvement of the environmental issues, operational efficiency is increased, which leads to non-waste production.

## **3. COMPARATIVE ANALYSIS**

Comparative analysis between standard dust collectors with highly effective capillary porous device with controlled geometry of micro channels [6] (fig.1 A and B) here is presented. This device helps to increase hundred times a duration between regenerations, and reduce 1,5 times a consumption of foam generator, which saves power for its transfer, fully utilize acoustic energy by decreasing three times a specific acoustic power. In addition, the device operation is simplified, duration between regenerations increases, and thus enhanced reliability and operational life of the device, leading to reduced investment and operational costs. Hydraulic and gas dynamic resistance will be decreased 1,5-2 times, and efficiency of the dust and gas collection will be 99,9 %.

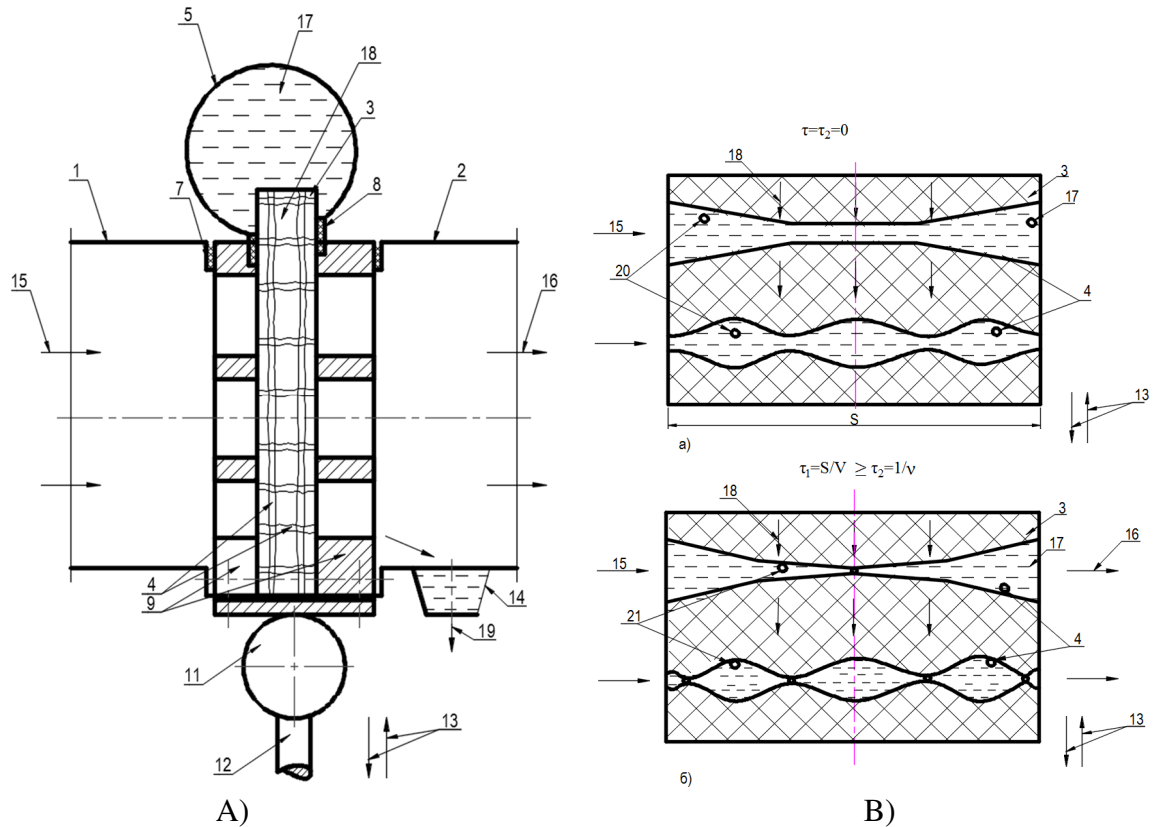

Figure 1: A) Highly efficient porous device with controlled geometry of micro channels; B) Capillary-porous material of dust and gas collector in a free (unloaded) state (a) and under the influence of acoustic oscillations (b).

Legend of Figure 1 A and B: 1 – inlet nozzle of contaminated gas, 2 – outlet nozzle of clean gas; 3 – capillary porous material (elastic polyurethane or elastic composite material with set of required properties); 4 – capillaries and pores; 5 – sprayer in a ring form with opening; 6 – perforated plates; 7 – bolt joint; 8 – pressed clips; 9 – flexible plate; 10 – screws; 11 – vibrator; 12 – bar; 13 – kinematic diagram; 14 – sludge collector; 15 – dust-and-gas flow; 16 – clean gas; 17 – foam forming solution; 18 – mass (gravity and pressure forces) and capillary forces; 19 – sludge; 20 – micro particles and micro drops; 21 – settled micro particles and micro drops.

#### 4. RESULTS

Table 1 presents the properties of dust collectors based on the performed study.

The markings in column 9 of Table 1 are as follows:  $C_K$  – Keningem-Milliken correction (average length of free path of gas molecules);  $D$  – diffusion rate,  $m^2/s$ ;  $d_p$  – diameter of particles,  $m$ ;  $E$  – electric field intensity,  $V/m$ ;  $e$  – electrone value;  $1,6 \cdot 10^{-19} Q$ ;  $G$  – mass flow rate,  $kg/s$ ;  $n_i$  – ion concentration,  $I/m^3$ ;  $T_g$  – gas temperature,  $K$ ;  $E_0$  – dielectric constant,  $8,85 \cdot 10^{-12} F/m$ ;  $\mu_g$  – dynamic viscosity of gas phase,  $Pa \cdot s$ ; Stokes criterion:  $Stk = (d_p^2 \cdot \rho_p \cdot V_r \mu_g) / 18$ , where  $V_r$  – relative gas velocity (in relation to drops, particles, streamlined bodies),  $m/s$ ;  $\rho_p$  – density of solid phase,  $kg / m^3$ .

General parameters of particle settling is as described in item 8 of Table 1:  $G$  – gravitational,  $W$  – centrifugal;  $Stk$  – inertial;  $D$  – diffusional;  $KE$  – due to electric forces;  $K$  – due to condensation of combined capillary and mass forces.



Table 1: Comparative Analysis of Different Dust Collectors

No.	Indicator	Chamber of gravitational dust collector	Inertial (centrifugal) dust collector	Cyclone (centrifugal medium-pressure)		Hose (fiber) filter	Granular filter	Wet filter	Wet Dust Collector		Electric filter	Wet filter of Author
				Large diameter (1-3m)	Small diameter and battery type				Low pressure	High pressure		
1	2	3	4	5	6	7	8	9	10	11	12	13
1	Hydraulic resistance, Pa	100-200	200-300	700-800	800-1250	750-1500	1200-1600	1000-1800	750-1500	5000-12500	100-400	500-1000
2	Minimum size of collected particles, $10^{-6}$ m and effectiveness ( $\eta\%$ )	50-100	40-50	30-40	10-25	0,5	0,1-1	1-2	2-5	0,1-1	0,25-1	0,1-0,25
		85	85	85	85	99	97	97	97	97	99	99
3	Maximum admissible temperature, °C	400	400	400	400	<80 и <250 for glass fibers	Not limited				<425 as per gas content and dust properties	Not limited
		(as per steel grade)										
4	Gas low limit temperature	Over dew point		Any							Over dew point	Any
5	Corrosion resistance	Too resistant				Resistant at temperature exceeding dew point			Required corrosion protection if acids available in gases		Resistant at temperature exceeding dew point	

6	Explosion and Fire Hazard	Minor				Major (hazardous)	Minor	Minimum			Major	Minimum	
7	Relative cost of cleanup of 1000m <sup>3</sup> gas	1	1,5	2	3	3-3,75	2,5-4	7-10	2,5-5	5-15	7-15	1-2,5	
8	Main settling mechanism	G	U	U	U	at $d_r \leq 3 \times 10^{-7} \text{ m} \sim D$ at $d_r > 3 \times 10^{-7} \text{ m} \sim \text{Stk}$		Stk	Stk	K <sub>E</sub>	D; K; Stk		
9	Dependancy of effectiveness from:	$\sim d_r^2 C_k \sim d_r^2 C_k$				at $d_r \leq 3 \times 10^{-7} \text{ m} \sim C_k/d_r$ at $d_r > 3 \times 10^{-7} \text{ m} \sim d_r^2/C_k$				$\sim d_r^2 C_k$	$\sim d_r C_k$	n, 7...9	
	a) particle size												
	b) temperature	$\sim C_k/\mu_r \sim C_k/\mu_r$				at $d_r \leq 3 \times 10^{-7} \text{ m} \sim C_k T_r/\mu_r$ at $d_r > 3 \times 10^{-7} \text{ m} \sim C_k/\mu_r$						n, 7...9	
	b) concentration (г/м <sup>3</sup> )	No impact	As per device diameter and dust adhesion (2500...15)				Not over 2g/m <sup>3</sup>	As per water supply system and power consumption (50...0,5)		Limited 50	n, 8...11		
	г) humidity upon condensate of water vapors	No impact		Discharge might be complicated		Fiber is clogged	Improves settling	No impact	No impact		Complicated dust removal	Improves settling	

### 3. CONCLUSIONS

The paper is a comparative analysis between the existing dust collector and designed one with capillary porous structure with controlled geometry of micro-channel.

The proposed simplified design, reduced amount of material in production, reduced power consumption for performing the air transfer, foam forming solution and steam generation are the reasons for reduced implementation costs of the proposed foam generators and dust collectors. Furthermore, consumption of foam forming solution is reduced, and efficiency of devices is increased due to the automatic reasonable correlation of components under different operational modes of dust cleaning equipment.

Last but not least, the suggested aero-hydrodynamic constructive diagrams of nozzle-free foam generators and dust-and-gas collectors on capillary porous structure meet the operational sanitary requirements, safety in operations of different industrial equipment, easy-to-manufacture and easy-to-operate.

### References

- [1] Polyayev V.M., Genbach A.A. Upravlenie teploobmenom v poristih strukturah, *Izvestiya Rossiiskoi akademii nauk. «Energetika i transport»*, 1992, T.38, №6-S. 105-110.
- [2] Polyayev V.M., Genbach A.A. Teploobmen v poristoi sisteme, rabotaushii pri sovместnom deistvii kapillyarnih i gravitacionnih sil, *Teploenergetika*, 1193, №7-S. 55-58.
- [3] Genbach A.A., Kulbakina N.V. Pilepodavlenie i pileulavlvanie s pomoshu cirkulacionnogo penogeneratora s poristoi strukturoi, *Energetika i toplivnie resursi Kazakhstana*, 2010, №4-S. 62-65.
- [4] Polyayev V.M., Genbach A.A. Upravlenie vnutrennimi harakteristikami kipeniya v poristoi sisteme // Kriogennaya tehnika i kondicionirovanie: *sbornik trudov MGTU*, 1991.-S.224-237.
- [5] Polyayev V.M., Genbach A.A. Primenenie poristoi sistemi v energeticheskikh ustanovkakh, *Promishlennaya energetika*, 1192, №1-S.40-43.
- [6] Genbach A.A., Piontskovskii M.S. Poristii pilegazoulovitel s upravlyaemoi geometriei mikrokanalov, *Energetika i toplivnie resursi Kazakhstana*, 2010, №4 -S. 59-61.
- [7] Polyayev V.M., Genbach A.A., Minashkin D.V. Processi v poristom ellipticheskom teploobmennike, *Izvestiya vuzov. Mashinostroenie*, 1991.-№4-6.-S.73-77.
- [8] Genbach A.A., Genbach N.A. Issledovanie penogeneratora s obogrevaemoi poverhnostu, *Vestnik AIES.-Almaty*, 2009, №4, S.24-27.
- [9] Genbach A.A., Genbach N.A. Issledovanie kapillyarno-poristih sistem v teplovi energeticheskikh ustanovkakh elektrostancii, *Vestnik AIES.-Almaty*, 2011, №2 (13), S.57-62.
- [10] Genbach A.A., Genbach N.A. Primenenie kapillyarno-poristih sistem v teplovi energeticheskikh ustanovkakh elektrostancii, *Vestnik AIES, Almaty*, 2011, №3, (14), S.4-11.
- [11] V.M. Polyayev, A.N. Genbach, A.A. Genbach. Methods of Monitoring Energy Processes, Experimental thermal and fluid science, International of Thermodynamics, Experimental Heat Transfer, and Fluid Mechanics. *Avenue of the Americas*, New York, volum 10, april, 1995, p.273-286.
- [12] Genbach A.A., Shokolakov K. Poristii pennii pileulovitel. MON RK, *Mezhdynarodnii nauchnii zhurnal - prilozhenie Respubliki Kazakhstan – Poisk №2 /2011 S. 266-271.*
- [13] Polyayev V.M., Genbach A.A. Plotnost centrov paroobrazovaniya i vibros kapel iz poristoi strukturi, *Izvestiya vuzov. Mashinostroenie*, 1990, №9, S. 50-55.
- [14] Poljaev V.M., Genbach A.A. Oblasti primeneniya poristoj sistemy, *Izvestiya vuzov, Jenergetika*, 1991, №12. - S.97-101.
- [15] Genbach A.A. Poristye teploobmenniki, Dep.ruk.VINITI. -1989. - №12 (218). - S.178. - (KazNIINTI. - 1989. - №2818. - 194 s.).
- [16] Romenskij L.G. Pena kak sredstvo bor'by s pyl'ju. - Kiev: *Naukova dumka*, 1976, 162s.
- [17] Spravochnik po bor'be s pyl'ju v gornodobyvajushhej promyshlennosti/Pod red. A.S.Kuz'micha. – M.:Nedra, 1982, S.103.
- [18] Idel'chik I.E. Spravochnik po gidravlicheskim soprotivlenijam. – M.: Mashinostroenie, 1975. – 559.
- [19] Isachenko V.P. Teploobmen pri kondensacii. - M.: Jenergija. 1977, 240 s.

# APPLICATION OF ECONOMIZER IN BIOMASS BOILER HOUSE IN BORYSPIL AIRPORT: CASE STUDY

Sofiia Heletukha<sup>1</sup>, Lead engineer, Master's degree

## ABSTRACT

Installation of economizer allows recovering significant part of physical and latent heat and reduce greenhouse gas and dust emissions in flue gases. Energy and ecology efficiency increment calculations for the 5 MW biomass boiler house in Boryspil Airport are described in this paper.

## 1. INTRODUCTION

According to the International Energy Agency, in preventing the global temperature increasing on the Earth more than to 2°C, concerning to the preindustrial period, the most important role in reducing CO<sub>2</sub> emissions in the period up to the 2050 will be playing energy efficiency (40%) and renewable energy (30%). Energy efficiency in biomass boiler house concerns both and that's why is actual nowadays.

According to the Energy Strategy of Ukraine until 2035 [1], Ukraine is going to reduce fossil fuels consumption and increase the share of renewable energy sources in the total primary energy production from 4% (in 2016) to 25% (in 2035). In recent years, biomass sector has accounted for about 80% of renewable energy in the country and is based mainly on utilization of woody biomass in heat generation: wood logs and wood pellets mostly for population and district heating, wood chips and residues mostly for industrial purposes, public heating and power production [2].

There are different energy loses in biomass boiler houses. Among them: loses due to chemical and physical incompleteness of combustion, loses by fencing structures etc. But most of the energy loses in a boiler are because of the high temperature of the flue gas. Boilers generally can lose 20% of heat of combustion. Thanks to the flue gas condensers boilers can recover up to 50% of this heat loss [3]. Therefore, recovering the waste heat from flue gas is a major area to increase the thermal efficiency of plants.

Average moisture content of wood chips used in the biomass boiler house is 40-60%. When combustion process starts, the fuel is heated up and water from the fuel starts to evaporate. Evaporation requires energy and this energy together with wet flue gases is released in atmosphere and is wasted. Part of this energy can be recovered if wet flue gasses are directed through a technical device called economizer.

## 2. OBJECTIVES OF THE PROJECT

Municipality owned district heating company supplies district heat for consumers in Boryspil Airport. Among the heat users there are terminals, public buildings and commercial buildings. The company owns and operates three boiler houses. Average efficiency of boiler houses is 85%.

In this boiler house there are six boilers with the total installed heat capacity 27 MW: five natural gas boilers (with total capacity 32 MW) and one biomass boiler POJ INKA 5000 (with 5 MW capacity).

The POJ INKA biomass boiler is operated to cover peak loads. The natural gas boilers are used to cover the base load and as back-up in case of emergency situations.

Economizer type Enerstena CEB 1000 (Figure 1) is installed in biomass boiler house.

---

<sup>1</sup>Institute of Engineering Thermophysics of NASU, Zhelyabova 2a street, tel.: +38 044 456 94 62, e-mail: [sofiia.heletukha@biomass.kiev.ua](mailto:sofiia.heletukha@biomass.kiev.ua);



Figure 1: Economizer Enerstena CEB 1000 in biomass boiler house in Boryspil Airport

Flue gases through the inlet pipe are introduced in the condenser. First nozzle circuits are located in the pipe. In the first step flue gases are cooled to temperature that is acceptable to condense heat in the second part. Solid particles in fuel gases (still left after gas treatment in the cyclone) are caught in the first nozzle circuit. The previously cooled flue gases are then injected in the second part of the condenser. Gases are moving from the top to the bottom inside the pipes and water is injected in intertubular space and moves towards gas. The purpose of the second step is to perform deep cooling of flue gases and steam condensing. Consequently the temperature of water injected through the second nozzles shall be as low as possible. The useful heat from the condenser is then returned back to district heating system.

The objective of this project is to increase the efficiency of biomass use by installation of economizer in biomass boiler house in Boryspil Airport.

### 3. ENERGY EFFICIENCY INCREMENT

The calculations are based on the following initial data:

- type of economizer: Enerstena CEB 1000,
- type of biomass boiler: POJ INKA 5000 (with nominal capacity 5 MWth, actual capacity is 60% from nominal capacity),
- fuel: wood chips, The moisture content in the fuel is between 40-60% (for further calculations the moisture content of wood chips were assumed 40%);
- return water temperature 40°C,
- flue gas temperature 100°C,
- no combustion air humidification is applied.

Heat loss and energy efficiency are calculated for low heating value (LHV) and high heating value (HHV) for wood-chips-fired boiler POJ-INKA 5000 (Table 1) and system “wood-chips-fired boiler – economizer” (Table 2).

Table 1: Thermal efficiency of wood-chips-fired boiler POJ-INKA 5000

			LHV	HHV	Unit
heat loss	with exhaust gas	$q_2$	5,92	20,4	%
	with chemical combustion incompleteness	$q_3$	1	0,85	%
	with mechanical combustion incompleteness	$q_4$	1,5	1,27	%
	with external cooling	$q_5$	0,35	0,3	%
	with ash heat	$q_6$	0,1	0,09	%
total heat loss		$\Sigma q$	8,9	22,9	%

efficiency factor	$\eta$	91,1	77,1	%
fuel consumption with nominal capacity	B	0,537	kg/s	1933,2
fuel consumption with actual capacity	B <sub>p</sub>	0,316	kg/s	1137,6

Table 2: Thermal efficiency of system “wood-chips-fired boiler – economizer”

			LHV	HHV	Unit
heat loss	with exhaust gas	q <sub>2</sub>	-6,25	8,7	%
	with chemical combustion incompleteness	q <sub>3</sub>	1	0,85	%
	with mechanical combustion incompleteness	q <sub>4</sub>	1,5	1,27	%
	with external cooling	q <sub>5</sub>	0,35	0,3	%
	with ash heat	q <sub>6</sub>	0,8	0,68	%
total heat loss		$\Sigma q$	-2,6	22,9	%
efficiency factor		$\eta$	102,6	88,2	%
fuel consumption with nominal capacity	B	0,47	kg/s	1692	kg/h
fuel consumption with actual capacity	B <sub>p</sub>	0,28	kg/s	998	kg/h

By establishing a economizer:

- the amount of heat losses with exhaust gas decreases, which leads to increase of efficiency of the system. Efficiency factor increased – by 11%, from 77% to 88% (by HHV) and from 91% to 103% (by LHV).
- Fuel savings:
  - with nominal capacity – 5000 kW): 241,2 kg/hour;
  - with actual capacity – 2944 kW): 129,6 kg/hour;
- with a constant fuel consumption in the system "boiler-economizer", the amount of useful heat used in it:
  - with nominal capacity – 5000 kW): 5,7 MWth;
  - with actual capacity – 2944 kW): 3,35 MWth

#### 4. ECOLOGY EFFICIENCY INCREMENT

The main pollutants formed during the energy use of biomass are nitrogen oxides (NO<sub>x</sub>), carbon monoxide (CO), sulfur oxides (SO<sub>x</sub>), and solids calculations are shown in the Figures 2,3.

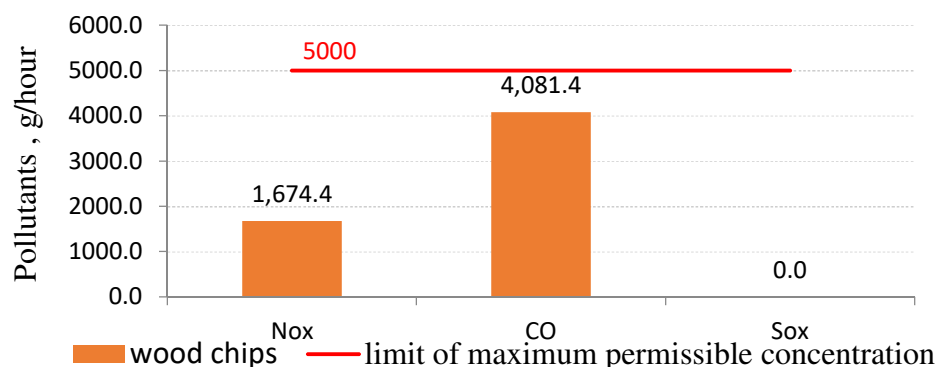

Figure 2: NO<sub>x</sub>, CO, SO<sub>x</sub> pollutants in wood-chips-fired boiler POJ-INKA 5000 flue gases, g/hour

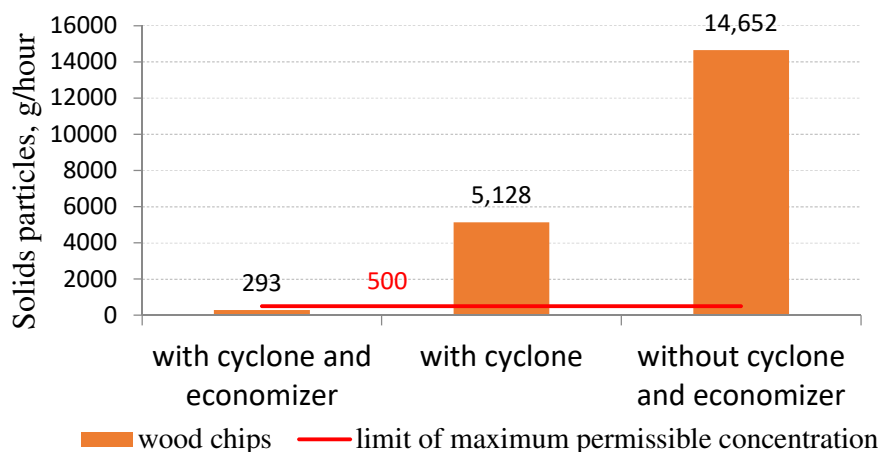

Figure 3: Solids pollutants in wood-chips-fired boiler POJ-INKA 5000 flue gases in different variants of cyclone and economizer installation, g/hour

Consequently, when burning wood chips in a 5000 kW biomass boiler, emissions of nitrogen oxides (NO<sub>x</sub>), carbon monoxide oxides (CO), sulfur oxides (SO<sub>x</sub>) are acceptable, and emissions of solids particles:

- without installing of cyclones and an economizer - are higher than the permissible norm:
- with the installation of cyclones, but without the establishment of the economizer - are higher than the permissible norm:
- from the installation of the block of cyclones and the economizer - are permissible.

## 5. CONCLUSIONS

As a result of above analysis the key conclusions could be formulated as follow:

Installation of economizer allows:

- to increase overall efficiency and reducing wood chips consumption by 241 kg/hour (with nominal capacity) and by 129,6 kg/hour (with actual capacity)
- to increase efficiency of the system. Efficiency factor increased – by 11%, from 77% to 88% (by HHV) and from 91% to 103% (by LHV).

When burning wood chips in a 5000 kW biomass boiler emissions of nitrogen oxides (NO<sub>x</sub>), carbon monoxide oxides (CO), sulfur oxides (SO<sub>x</sub>) are acceptable, and emissions of solids particles:

- without installing of cyclones and an economizer - are higher than the permissible norm:
- with the installation of cyclones, but without the establishment of the economizer - are higher than the permissible norm:
- from the installation of the block of cyclones and the economizer - are permissible.

## References

- [1] International Energy Agency [World Energy Outlook Special Report 2015: Energy and Climate Change](#)
- [2] National Renewable Action Plan till 2020 in force since 1 October 2014 (Decree of Cabinet of Ministers # 902-r)
- [3] Geletukha G., Oliynyk E., Zheliezna T. *Prospects for heat production from biomass in Ukraine* – 6th Position Paper of UABio (in English), Bioenergy Association of Ukraine, Kyiv, Ukraine, 2013, 22 p. <http://uabio.org/img/files/docs/position-paper-uabio-6-en.pdf>
- [4] Kemal Comakli, Meryem Terhan (2016). Energy and Economic Analysis of Heat Recovery from Boiler Exhaust Flue Gas. *International Journal of Energy and Power Engineering: World Academy of Science*. pp. 450-456.
- [5] 2. Jakobsen H.H. (1991). Flue Gas Condensation of Chip Fired Boiler at District Heating Plant: Danish Institute of Forest Technology.

# PERFORMANCE ANALYSIS OF A BIOGAS-FUELLED GAS TURBINE COGENERATION SYSTEM

Ion V. Ion<sup>1</sup>, Florin Popescu, Simona Lizica Paraschiv, Spiru Paraschiv  
“Dunarea de Jos” University of Galati, Romania

## ABSTRACT

Economic viability of a biogas plant depends mainly on the energy efficiency of combined heat and power plant, cost of fuel and green certificates and heat demands and price. When there is not heat demand, one way to maintain the plant economic efficiency is to use the heat for electricity generation. This can be done by combination of prime mover with steam or organic Rankine cycle (ORC) engine. A biogas-fuelled gas turbine combined with ORC cycle for a biogas plant with capacity of 210 Nm<sup>3</sup>/h can increase the electric efficiency to 49% from 40.6%, the electric efficiency of gas turbine CHP plant. The investment cost can be recovered in 4.1 years.

## 1. INTRODUCTION

The number of biogas plants for the treatment of wet livestock wastes, from wastewater treatment plants and landfill gas recovery is increasing in Europe and worldwide due to the advantages of biogas use: biogas can be stored for later use; if converted into electricity and/or heat, biogas plants reduce greenhouse gas (GHG) emissions, with reducing of waste amount and generating valuable fertilizer; it can add energy independence, and hence value, to the region where it is used and boost employment [1, 2, 3]. There were 17240 biogas plants in Europe in 2015 with a production of about 0.57 EJ or 45% of world production [1]. The energy, environmental and economic performance of a biogas plant depends on the overall energy efficiency of biogas plant and on how it is used the excess heat from biogas plant [1].

Most biogas plants use a combined heat and power (CHP) system to convert biogas on site into electricity and heat. A CHP system converts (35 – 40)% of the energy contained in biogas into electricity and (40-45)% into heat. The heat is used to control the temperature of the anaerobic digestion and for space heating of administration building and what remains is sold. The excess heat that is not used compromises the economic performance of the biogas plant. There are many biogas-fuelled CHP technologies, such as internal combustion engines, gas turbines, steam turbines, Stirling engines, fuel cells and combined cycles.

The most widespread technology in USA in 2014 was gas turbine technology with 64% capacity share, followed by steam turbines with 32.1% and internal combustion engine with 2.7% (over half of the CHP systems in place) [4].

Among these technologies, internal combustion engines show high power efficiency at part-load operation, relatively low investment cost and operation on low-pressure gas, high maintenance cost and need of cooling. The gas turbines achieve the highest electric efficiency when operating in combined cycle, they need not cooling but require high pressure gas (or gas compressor) and have poor efficiency at low loading. Steam turbines can use a large variety of fuels, have long working life, but have very low power to heat ratio. Fuel cells have low emissions and noise, high efficiency over load range and are less widespread due to the high investment cost and the necessity of fuel processing. Stirling engines are considered as the

---

<sup>1</sup>111 Domneasca St.; +40740566214; iion@ugal.ro



most promising technology for micro-CHP applications due to their characteristics of low emissions, high efficiency and reliability. They are still in the “early adaptors” phase due to relatively high costs [5, 6, 7].

Gas turbines are a commercial technology in biogas applications with capacity in the range of 25 kW to above 500 kW. The performance is highly influenced by two parameters: the pressure ratio and the firing temperature. The thermodynamic efficiency increases with the increase of compression ratio, which is dependent on the design. Gas turbines for power generation can be either industrial (heavy frame) or aeroderivative designs. Industrial gas turbines have lower pressure ratios – typically up to 18:1. Aeroderivative gas turbines operate at higher compression ratios – up to 30:1, offer higher efficiency and lower emissions, but have higher initial (capital) costs. The efficiency increases also by augmentation of the temperature at which the turbine operates (firing temperature). However, this temperature is limited by the maximum allowable temperature of the turbine blade metal alloy. It can be in the range of 1200°C to 1400°C, but can reach 1600°C when blade coatings and cooling systems are used. The energy conversion efficiency of a simple cycle gas turbine power plant is typically about (30-40)%. By recovering the heat remained in the exhaust gas leaving the turbine at 600°C, to produce more useful work in a combined cycle configuration, gas turbine power plant efficiency can reach (66 – 71)% [9].

In this study, energy and economic assessment of a biogas-based gas turbine system with preheater and waste heat recovery is performed. The effects of waste heat recovery on the energy and economic performance of a plant are studied.

## 2. METHODOLOGY

In the work, a gas turbine system for a biogas plant with capacity of 210 Nm<sup>3</sup>/h was considered. For waste heat recovery were chose the simple way of recovery in a heat exchanger and recovery in an Organic Rankine Cycle to generate electricity. The energy simulation and optimisation was performed by using the Cycle-Tempo Release 5.1.5 software in combination with the FluidProp software package, both developed by the Delft University of Technology and by TNO, the Dutch Institute for Applied Research [10]. The system configurations and energy assessment are given in Figures 1 and 2. The main thermodynamic parameters of system are the following: pressure ratio 18:1; gas temperatures at the turbine inlet 1600°C; air fuel ratio 22.38; gas temperatures at the turbine outlet 600°C; gas temperatures at the stack 120°C. The working fluid for the ORC system was selected toluene because it is most suitable for the thermal level of waste heat of gas turbine system.

In addition to energy efficiency and environmental performance, economic performance of the energy systems is also important. The studies on internal combustion engine CHP system fuelled by biogas have shown that the cost of fuel and green certificates are the most important factors for economic viability of the system [11]. Study on a CHP plant based on gas turbine using co-firing natural gas and biogas concluded that economic of the plant is affected greatly by changes in fuel combination. Economic analysis of CHP and Combined Cycle based on a 5 MW biogas fueled gas turbine, economically conducted with fixed fuel composition concluded that CHP is generally more profitable especially at high heat demands and prices [11].

The investment costs of a gas-turbine CHP plant ranges from 744 €/kWe to 1260 €/kWe, with a typical cost figure of 825 €/kWe. The annual operation and maintenance (O&M) costs are approximately 33€/kWe. The investment costs of a high temperature ORC module range from 1000 €/kWe for 2 MW output to 3000 €/kW for 150 kW output [12, 13].

The energy and economic characteristics of both systems are given in Table 1.

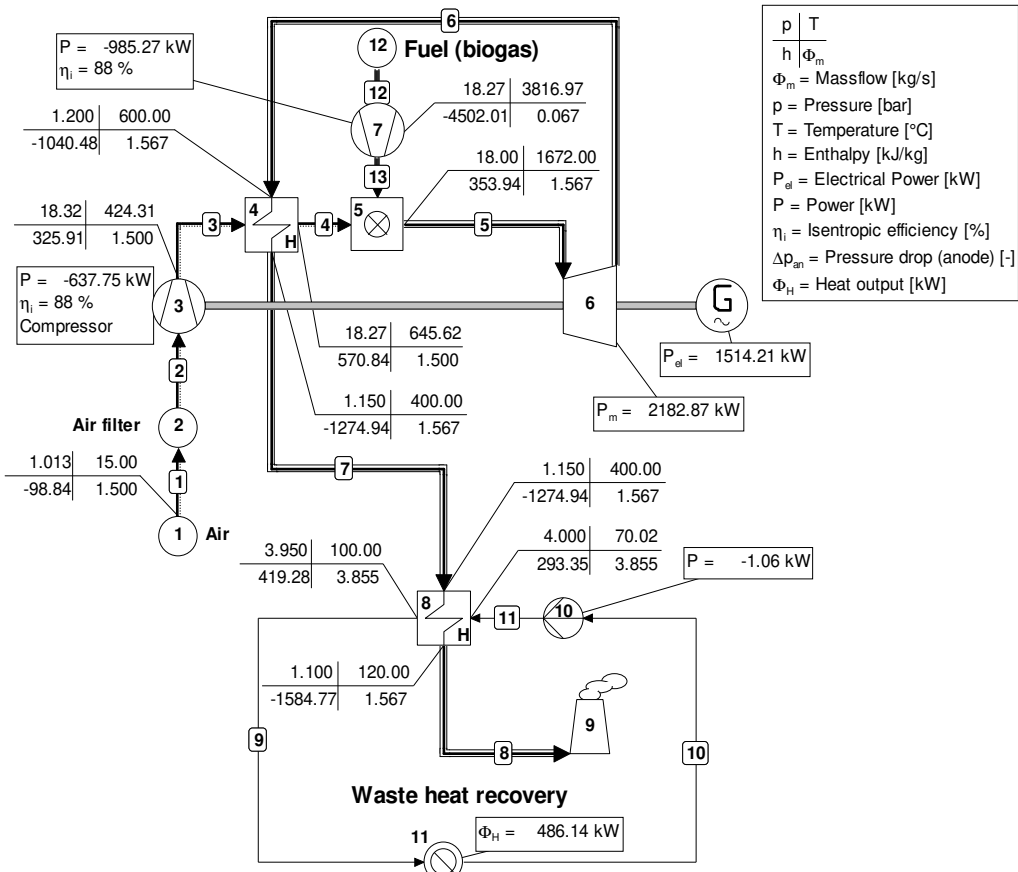

Figure 1. CycleTempo simulation of biogas-fueled gas turbine cogeneration system.

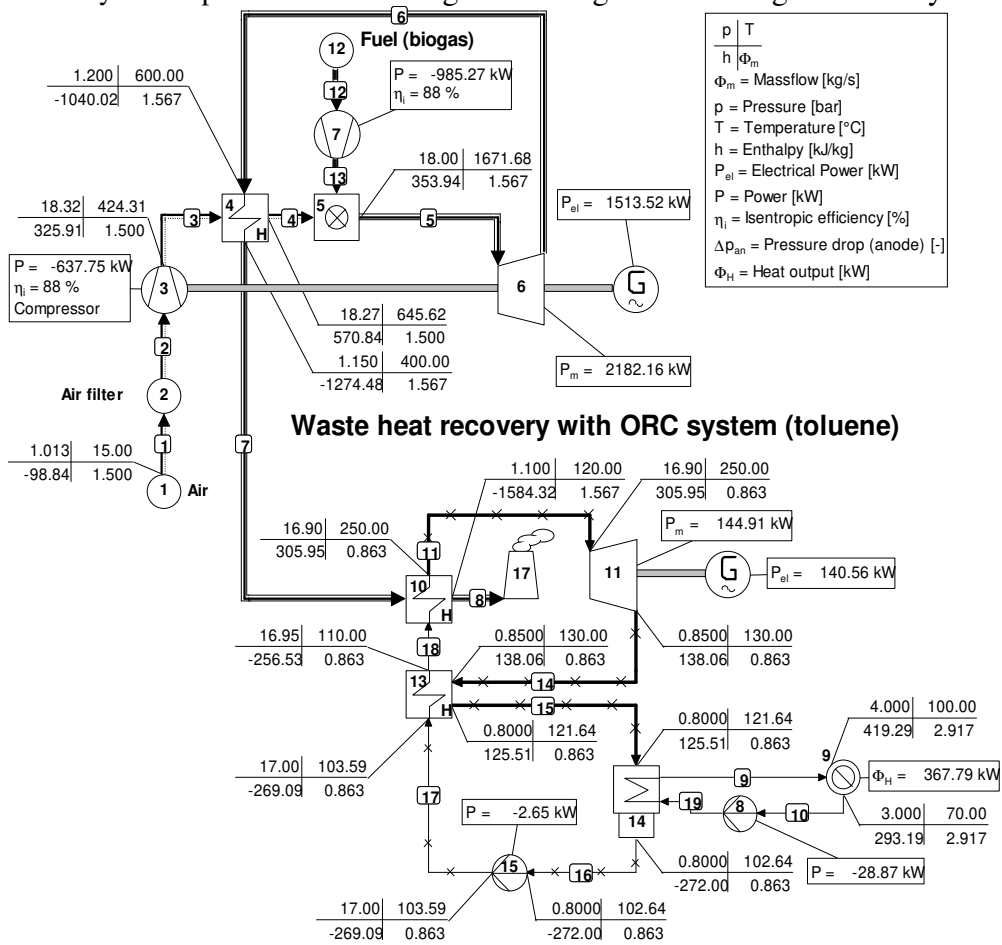

Figure 2. CycleTempo simulation of biogas-fueled gas turbine combined with ORC system.

Table 1. Energy and economic features of the biogas-fuelled gas turbine systems.

Parameter \ System	Gas turbine CHP system	Gas turbine combined with ORC system
Investment costs, €	1032500	1214220
O&M costs, €/year	20000	25440
Electricity output, kW <sub>e</sub>	527.88	637.29
Heat output, kW <sub>t</sub>	486.14	367.79
Hours of plant operation, hrs/year	6000	6000
Electricity cost, €/kW <sub>e</sub>	0.12	0.12
Cost of green certificate, €/MW <sub>e</sub>	10	10
Payback period, years	3.5	4.1

### 3. CONCLUSIONS

A gas turbine system with preheater associated with a biogas plant with capacity of 210 Nm<sup>3</sup>/h was simulated and optimised, by using the Cycle-Tempo software, for two configurations of heat recovery: in a heat exchanger and in an organic Rankine cycle system. The electricity output for the second configuration increases by 29% and the heat output decreases by 25%. For given cost of electricity and green certificates, the investment costs are recovered in 3.5 years in first case and 4.1 years in the second case.

### References

- [1] Herbes C., Halbherr V., Braun L., *Factors influencing prices for heat from biogas plants*, Applied Energy 221 (2018), pp. 308–318.
- [2] Zafar S., *Trends in Utilization of Biogas*, November 21, 2015, <https://www.bioenergyconsult.com/tag/biogas-turbine/>
- [3] Scarlat N., Dallemand J-F., Fahl F., *Biogas: developments and perspectives in Europe*, Renewable Energy 2018.
- [4] U.S. Environmental Protection Agency, *Catalog of CHP Technologies* [https://www.epa.gov/sites/production/files/2015-07/documents/catalog\\_of\\_chp\\_technologies.pdf](https://www.epa.gov/sites/production/files/2015-07/documents/catalog_of_chp_technologies.pdf)
- [5] Gupta K.K., Rehman A., Sarviya R.M., *Bio-fuels for the gas turbine: A review*, Renewable and Sustainable Energy Reviews, Vol. 14, Issue 9, 2010, pp. 2946-2955.
- [6] The Energy Technology Systems Analysis Program (ETSAP), [https://iea-etsap.org/E-TechDS/PDF/E04-CHP-GS-gct\\_ADfinal.pdf](https://iea-etsap.org/E-TechDS/PDF/E04-CHP-GS-gct_ADfinal.pdf)
- [7] Kim S., Sung T., Kim K.Ch., *Thermodynamic Performance Analysis of a Biogas-Fuelled Micro-Gas Turbine with a Bottoming Organic Rankine Cycle for Sewage Sludge and Food Waste Treatment Plants*, Energies, 2017, 10, 275.
- [8] Rade M.C., Zoran K., *Techno-Economic Analysis of Biogas Powered Cogeneration*, Journal of Automation and Control Engineering Vol. 2, No. 1, 2014.
- [9] <https://www.wartsila.com/energy/learning-center/technical-comparisons/gas-turbine-for-power-generation-introduction>
- [10] Simulation software Cycle-Tempo (<http://www.asimptote.nl/software/cycle-tempo/>)
- [11] Barzegaravval H., Hosseini S.E., Wahid M.A., Saat A., *Effects of fuel composition on the economic performance of biogas-based power generation systems*, Applied Thermal Engineering 128 (2018), pp. 1543–1554.
- [12] The Energy Technology Systems Analysis Program (ETSAP), [https://iea-etsap.org/E-TechDS/PDF/E04-CHP-GS-gct\\_ADfinal.pdf](https://iea-etsap.org/E-TechDS/PDF/E04-CHP-GS-gct_ADfinal.pdf)
- [13] Lemmens S., *Technological innovation in the energy sector: case of the organic Rankine cycle*, PhD Thesis, Universiteit Antwerpen, 2017.

# INTEGRATION OF MICRO-COGENERATION SYSTEMS INTO EXISTING BUILDINGS

Alin IONESCU, Linda BARELLI, Gheorghe LAZAROIU,

University Politehnica of Bucharest, Faculty of Power Engineering  
Università degli Studi di Perugia, Facoltà di Ingegneria

## ABSTRACT

Because of the growing environmental awareness and the ratification of the Kyoto Protocol, combined heat and power receives again more attention as a way to contribute to the reduction of energy use and emissions. Buildings account for 40 % of total energy consumption in the European Union. The sector is expanding, which is bound to increase its energy consumption. Nowadays, micro-cogeneration systems became a true and good solution to sustain the energy demand of industrial and even domestic buildings. They are operating between 0 kWh – 50 kWh. The district heating set up with a cogeneration system, concurs to attain energetic, economic and ambient benefits. It also provides to citizens a new service. The project strategy is based on the idea of supplying a portion of the necessary thermal power through a combustion alternative engine in cogeneration modality.

## 1. INTRODUCTION

Cogeneration system is an ultimate technology, which can reduce energy cost and improve the efficiency. The CHP system can provide both type of energy, electrical and thermal. The benefits of this type of technology are worldwide know:

- Increase efficiency of resources use: It is the most efficient technology in converting the fuel power into electrical and thermal energy, reaching approximately 30% energy savings, compared with separately production of those two types of energy.
- Reduce of carbon foot-print: Cogeneration is a technology with reduce carbon emissions, having the potential of reducing, up to 30% of emissions for fossil fuels or 100% when you are using renewable sources of energy (biomass, biogas, etc.)
- Compatible solution with solar panels: This type of systems, CHP, can produce electricity in a constant and flexible way, even in winter periods during the night, when the solar panel system that are in stand-by, or when they are producing energy intermittently.
- Safety of energy supply: This system may be used like a safety supply power plant, in this way it is improved the energy supply system, in some cases additional components are needed and other operational standards.
- Plug and play: CHP systems are make part from the few energy savings technology, which can deliver heat at high temperature (more than 80 Celsius degree).

Usually, between 85 and 95 % from primary energy consumed by the cogeneration power plant, it is transformed in useful energy, which show us high efficiency, compared to other conventional systems. For this technology to be feasible form economical point of view, it is necessary that the CHP system should be operated 14 hours per day or 5000 hours per year.

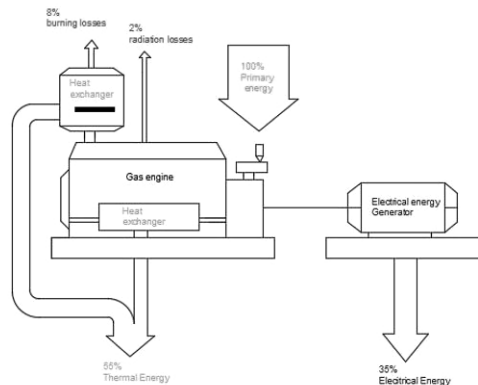

Figure 1.2. The schematic diagram of a cogeneration system (internal combustion engine)

So, if you want to adopt this solution to produce energy, to the detriment of conventional systems will go to these consequences:

- a) Low cost for electrical energy purchase (decrease the electrical energy purchase from grid, savings with regular taxes on distribution network and other electrical taxes)
- b) Extra incomes from incentives linked to cogeneration systems
- c) The opportunity to offer system services to electrical energy operator
- d) Improvement of carbon foot-print, reducing the environment pollution

Cogeneration or CHP units of 5-50 kWe are commercially available on the market. Most of these are based on reciprocating engine technology (gas engines), but also a few small appliances based on gas turbines can be found. They have a power-to-heat ratio of approximately 1:2, and the heat output of these units will generally then be within 15-120 kW. Internal combustion engines (ICE) dominate the market, but gas turbine is also a possible technology. The gas engines are spark ignited (Otto cycle) and operate either close to stoichiometric conditions allowing three-way catalysts to be used for emission reduction or are designed for lean-burn operation.

Often the system comprising a CHP unit also includes heat storage and additional boilers. The heat storage has several purposes, and the boilers are used for the heating demand when it exceeds the CHP heat output. To achieve the best electrical production efficiency and to benefit the most from the investment, the CHP units should (if possible) be operated at full load and for many hours per year. This means a sort of base load operation seen from a heat supply point of view. Ordinary and less costly boilers must then cover peak load heating periods or periods with low value for the electricity produced.

It is clear that the different technologies show a wide range of electric efficiency where the commercially available technologies, such as the Stirling engine unit and the combustion engine units, are less efficient. Fuel cells for micro CHP purposes are still in the development and field test phase, except for Japan where they have been available for everybody since 2009. The energy balance for single-family houses in north-western Europe (UK, the Netherlands, Germany and Denmark) with an annual demand of approximately 5,000 kWh electricity and 17,000 kWh heating and hot water is roughly as follows: The micro CHP unit ( $\eta_{el}=30\%$ ) produces 5,000 kWh electricity, of which half is exported to the grid, and 10,000 kWh heat to be used for heating and hot water.

## **2. HOW TO SELECT CHP SYSTEM FOR AN EXISTING BUILDING**

Initiating a CHP evaluation is a decision that requires careful consideration. Key-aspects of this part of the process are as follows:

- a) There must be a belief that the evaluation can lead to a viable project.
- b) The evaluation must be properly planned.
- c) It must be recognized that the evaluation will require investment in terms of both time and resources.

The CHP evaluation process tends to develop over time, the results of one stage defining the needs of the next. Hence, it is difficult to predict accurately the skills required. The initial feasibility study can often be completed with relatively low levels of overall input.

An organization cannot always meet the CHP evaluation requirements from its available in-house resources. It is then appropriate to consider calling external expertise to support or carry out the work.

An initial feasibility study is mainly a desktop exercise designed to provide an estimate of the cost savings and financial returns that can be achieved by installing an appropriate CHP plant. The study does not need to be excessively long or complex, but it must be carried out thoroughly by someone who has the right evaluation skills and engineering knowledge.

### **2.1. ASSESSMENT OF SITE ENERGY**

**Demands:** It is important to carry out the initial feasibility study using the best possible assessment of the site's future energy consumption. Past consumption data, which can be obtained from site utility bills, usually provide a good indication of future demands, but it is also important to take site-specific factors into account.

Efficiency of energy use: It is important to ensure that energy is used as efficiently as possible. Future changes in site energy demands. Most sites undergo changes in energy use and equipment over relatively short periods of time, so a CHP plant must be assessed not only against present energy demands, but against those anticipated for the future. Use of heat to replace electricity. There may be opportunities to replace electrically driven refrigeration plant with heat-driven refrigeration plant that operates on an absorption cycle. This approach may be particularly relevant where older electrically driven plant is due for replacement, or where cooling and heating demands are seasonal and do not usually occur simultaneously.

Timing of demands: Since CHP produces heat and power simultaneously it is essential to consider the extent to which the site has concurrent heat and power demands that can use the outputs of a CHP installation. This requires a time-based assessment of the site's energy demands. For the purposes of the initial feasibility study, it is sufficient to consider site consumption over a one-year period, subdividing this period into a time bands, according to actual site demand conditions.

This split would typically be based on distinction between:

- a) Daytime and night-time.
- b) Weekday and weekend.
- c) Summer and winter.

The site supply data required include:

- a) The number of hours of the year allocated to each time period. This should total 8,760, thereby representing demand over a full year.
- b) The average site electricity demand in kW for each time period.
- c) The average site heat demand in kW for each time period.
- d) The average cost per unit of electricity consumed in each time period.
- e) The quantity of fuel consumed on-site to provide the heat demand identified above.
- f) The cost per unit of the fuel identified above.

The data can be used to make an initial assessment of the annual cost of meeting future site energy demands. These are the costs that a CHP plant would reduce by supplying the energy requirements more efficiently.

## **2.2. SELECTING CHP PLANT**

Once the energy and cost data have been collected and tabulated, the next stage of the initial feasibility study is to select a potentially suitable CHP system. As a minimum, information obtained should include:

- a) Electrical output, which should include data relating to the power consumption of the CHP plant's own motors etc., so that the net output can be defined.
- b) Heat output that can be recovered for use on-site, including data on the temperature and flow rate of the fluid in which the heat is contained.
- c) Fuel consumption of the equipment, taking care to ensure that this can be expressed in gross calorific value terms.
- d) The cost of supplying and installing the equipment.
- e) The dimensions and weight of the equipment.
- f) The approximate cost per kilowatt hour (kWh) generated that should be allowed for servicing and maintaining the equipment.
- g) Any essential auxiliary items that are not contained within the scope of the equipment.

Sizing on heat demand will maximize energy and environmental savings. Depending on the heat to power ratio of site energy demands, sizing to match the heat requirement will result in a scheme that may offer a surplus of electricity generation (eg. during the night) or may require top-up electricity supplies (eg. at times of peak electricity demand). The economics of exporting the electricity then becomes a key issue in determining economic CHP plant size.

Before sizing a CHP scheme around the thermal load or power requirement it makes sense for prospective sites to consider carefully all possible energy efficiency investments/measures that could reduce the overall heat and electricity requirements. Only when energy efficiency has been maximized should the CHP scheme be finally sized.

### 3. CASE STUDY

In the present study, we integrate and do the economic optimization of a micro-CHP system, composed of prime mover, fed by natural gas (NG), a TES and 3 heating boilers producing heat during the cold season, for a Hotel situated in Romania, city of Predeal. Two heat-led operational strategies have been implemented in order to evaluate the operation scheduling that maximizes the revenues for the energy cogeneration with respect to the separate generation. The first strategy limits the prime mover production to the user DHW request and the heat request it is covered by the heating boilers, while the second novel the prime movers try to cover all the heat request and the electrical energy produced in excess by the PM, it is feed into the grid. The analysis of the micro-CHP system has been realized using an algorithm developed by me and my coordinator, Linda Barelli, in Microsoft Excel. Next step it is to collect the data about the building. We start with the configuration of building and then the energy consumptions on the past year.

#### 3.1. CONSTRUCTION DETAILS

The Hotel it is formed by basement, ground floor, and four floors, which has 20 double rooms, a restaurant, a kitchen and a terrace. Our survey it applies for the Hotel without the terrace. For terrace, we assume a fixed consume at full house and then variates simultaneous with the occupancy level of the Hotel. It has the following characteristics:

Surface of windows area = 478.04 m<sup>2</sup>. To obtain the surface of walls, we first calculated the hole exterior surface of hotel and decrease the windows area calculated upper, in this way we have the result, S<sub>walls</sub>=801.96 m<sup>2</sup>. In addition, we determined the horizontal areas, S<sub>horizontal</sub>=478.04 m<sup>2</sup>. Useful volume to heat, has this value V= 2058 m<sup>3</sup>. With all of this initial data and regulative regarding the thermo-technical calculation elements of buildings construction type, C-107/2005, we determined the global thermal insulation coefficient.

$$G = \frac{1}{V} * \sum \left( \frac{A * \tau}{R'm} \right) + 0.34 * n$$

Where:  $G$  - global thermal insulation coefficient

$V$  - Useful volume need to heat

$A$  - Built area of building

$R'm$  - The average corrected thermal resistance of a building element on the whole building

$T$  - The correction factor for outdoor temperatures, and it is 0.9 for our case

$n$  - the ventilation speed or the number of air exchanges with the outside per hour, in our case has a value of  $n = 0.756$ .

The values for  $T$  and  $n$ , are taken form the regulative C-107/2005, related to the building characteristics.

Global thermal insulation coefficient = 2.000

#### 3.2. BUILDING ENERGY CONSUMPTIONS ON THE PAST YEAR (2016)

Natural gas consumptions are obtained when the heating request, it is covered just by boilers and the electricity it is bought from grid. We took in consideration the terrace consumption, because both buildings are measured by the same gas meter. Applying the same algorithm to terrace in determining the gas consumption and sum it with the gas consumption determined for the Hotel, we could compare with the values recorded on bills, and have accurate results using the algorithm, with a total gas consumption of  $C = 547,819.21$  kWh/year. We split the year in two seasons, the cold one, from September to April, and the hot one from May to August, and during the cold season we consider the interior temperature it is divided in 2 values, 22 Celsius degree between 6 AM – 10 PM and 18 Celsius degree between 11 PM - 5 AM. Electrical energy consumption has been recorded hourly during the entire year.

#### 3.3. SYSTEM DESCRIPTION

The MCHP unit is the “XRGI 15” marketed by EC-POWER. An XRGI system consists of three main components – the Power Unit, Q Heat Distributor and the iQ Control Unit. The MCHP unit’s built-in generator provides a maximum electrical output of 15 kW<sub>el</sub>, which,

alternatively, can be modulated to 11.3 or 7.5 kW<sub>el</sub>. In the work presented here, the MCHP unit was operated according to two scenarios. The corresponding steady state thermal output of the MCHP unit is 30.6 kW<sub>th</sub>, while it is 25.8 and 20.6 kW<sub>th</sub> for the modulated output levels. The built-in generator of the MCHP unit generates electricity at 230V and 50 Hz. The MCHP unit is fully integrated into the building's electrical network. Generated electricity can therefore either be consumed or fed back into the public grid. Thermal energy from the engine is recovered via the engine cooling air, the exhaust gas and the engine oil. Furthermore, heat removed from the air-cooled electric generator is also recuperated. A single supply line discharges thermal energy from the MCHP unit to the TES system and a single return flow line connects the TES tank with the MCHP unit.

The peak boilers are connected in a common distributor with the flow lines from MCHP unit/ TES. The DHW flow circuit is also physically separated from the heating system and heat exchange between the two flow circuits is taking place within another two TES via a built-in single straight-tube heat exchanger. In the primary circuit which is common with the heating circuit works with the following temperatures, goes to the user with 80 Celsius degrees and return with 60 Celsius degrees, this applies to the heat exchangers for DHW too. The secondary circuit, which is the circuit for DHW it is working between this temperature, enters the circuit with 10 Celsius degrees from supply system and goes up to 60 Celsius degrees for user request.

Table 3.3.1. ICE XRGI 15 technical data

EC Power XRGI 15				
Power modulation	50	75	100	%
Electric output modulating	7.5	11.3	15	kW
Thermal output modulating	20.6	25.8	30.6	kW
Power consumption gas, in accordance with Hi	30	40	49.5	kW
Electrical own demand production	0.054	0.056	0.056	kW
Electrical own demand, stand by	0.025			kW
Electrical efficiency, in accordance with Hi	25	28.1	30.5	%
Thermal efficiency, in accordance with Hi	68.7	64.5	61.8	%
Total efficiency, in accordance with Hi	93.7	92.6	92.3	%

The TES system, which is also supplied by EC POWER, is a 957 L, sensible heat storage system containing water as the storage fluid. It has a maximum thermal capacity of approximately 22.6 kWh<sub>th</sub>, max pressure 6 bar, and max. temperature 95 Celsius degrees. For simulation, we've took the volume 1000 L, equal to 23.26 kWh<sub>th</sub>.

The three boilers are manufactured by the same supplier Buderus, the model is Buderus Logan Max Plus GB162-100, with the efficiency of 98% and a load of 94.5 kW<sub>th</sub>.

### 3.4. FIRST SCENARIO

Using the MCHP system to cover just DHW request and the boilers taking care of the heat request.

Regarding the thermal energy balance, we see a drop of 20% of gas consumption. The total electrical energy produced by MCHP represent like 5% from Hotel's request. During an entire year, the overall cost drops with aprox. 10%. This NPV calculation show us the period of investment return. And according to this scenario it is 11 years, and usually the manufacturer gave us a life-time of MCHP from 10 to 15 years, so is not a good way to operate the cogeneration system like this, in addition the number of operating hours it is aprox. 2500.

### 3.5. SECOND SCENARIO

Using MCHP to cover the heat and DHW request with the help of Boilers.

In this case the overall gas consumption has a drop with just 9%, but the electrical energy production has been increased with 21.5% from overall consumption and we have periods when can sell electricity to grid or to storage. The total cost of both energy in this case it is aprox. 55.000 euros, which represents a drop from the initial cost of 17 %. Results of this scenario show us that the investment return it is possible in 5 years, the net annual savings it is almost 10.000 euros and the number of operating hours it is aprox. 5500.



## 4. CONCLUSIONS

Having as reference the past year consumptions, we get the following results, the annual cost for both energy it is around 66.000 euros, and in separate values we have 21779.63 euros for thermal energy, representing 33% from total cost. Electrical energy it is 43941.12, representing 67% from total cost.

Doing the simulation according to scenario 1, we obtained an annual cost of almost 60000 euros, which means a reduce of 10% from overall cost, reduce of 20% from gas cost and a reduce of 9% from energy cost. Given the balance of thermal and electrical energy from reference year and the fact that we want the production of electrical energy to be maximized, the result doesn't fit to us. In addition, the investment return, it is too high, 12 years, because the manufacture give a life time to the ICE from 10 to 15 years.

Following the results of scenario 3 simulation, we have a reduce of 17% from overall annual energy cost. If we check the gas cost, we see that, it is a small drop comparing to the first scenario where we had 20%, being just 9% from annual gas cost in this case. Electrical energy production has increased from 5% in first case to 21.5%, which give us an investment return in only 5 years.

Making an analysis of the obtained results, the best way to operate the MCHP system it is the second scenario, trying to maximize the electrical energy production, which gave us high annual savings.

## AKNOWLEDGEMENTS

*„This work was supported by a grant of the Romanian Ministry of Research and Innovation, CCCDI – UEFISCDI, project number **PN-III-P1-1.2-PCCDI-2017-0404 / 31PCCDI/2018**, and project number **37BMPNIII-P3-199/2016-I05.16.01**, within PNCDI III’*

## References

- [1]T. Greu ș.a. – Mașini Mecanoenergetice Editura didactică și pedagogică, 1983.
- [2]Carabogdan, I. G., ș.a. - Manualul Inginerului Termotehnician, Editura Tehnică, București, 1986
- [3]Black & Veatch, – Power Plant Engineering, Editura Springer Science+Business Media, Inc., 1996
- [4]A. Badea ș.a. – Echipamente și instalații termice, Editura Tehnică, 2003
- [5]Barelli L, Bidini G, Gallorini F, Ottaviano A. Dynamic analysis of PEMFC-based CHP systems for domestic application. Applied Energy 2012;91(1):13–28. ISSN 0306-2619.1016/j.apenergy.2011.09.008.
- [6]L. Barelli \*, G. Bidini, E.M. Pinchi, Implementation of a cogenerative district heating: Optimization of a simulation model for the thermal power demand
- [7]L. Barelli \*, G. Bidini, E.M. Pinchi, Implementation of a cogenerative district heating system: Dimensioning of the production plant
- [8]\*\* - Websites of some manufactures of energy equipment or paper work of them General Electric (<http://www.gepower.com>), Siemens (<http://www.siemens.com>), EC Power (<https://www.ecpower.eu>) etc.;

# THERMAL ENERGY STORAGE FOR MICRO COGENERATION SYSTEMS

Alin IONESCU, Linda BARELLI, Gheorghe LAZAROIU,

University Politehnica of Bucharest, Faculty of Power Engineering  
Università degli Studi di Perugia, Facoltà di Ingegneria

## ABSTRACT

To design a thermal energy storage system (TES) it is necessary to identify a reversible process which can exchange large amounts of thermal energy per unit of volume and mass. From aggregation state point of view, liquids are used, because gases had low density requires large volumes. Solids can't be used as link agent between thermal energy source and storage systems or consumer. From a quantitative point of view, thermal energy storage processes allow energy on discharge to be comparable with the one received by TES at the charge. From a qualitative point of view, charge/discharge of TES can be done at low thermal levels differences (low exergy reduction), as well as to high thermal level differences (high exergy reduction). The energetic efficiency is good at TES, but in systems that requires to use mechanical work we have to consider the exergetic efficiency.

## 1. INTRODUCTION

Thermal energy storage systems are useful when source/consumer has important variations of producing/requesting heat. For example, this type of situation appear when:

1. Heat sources are flashing:
  - Industrial flashing processes;
  - Solar energy production (renewable energy sources);
  - Heat production from primary energy has important flashing variations (biomass, biogas etc.)
2. Heat/cold consumer is urban:
  - Heat request for domestic water is low (minimum during the night);
  - Heat request is high during the night for heating;
  - Cold request has an important grow (maximum during the day).
3. Electrical energy peak (possibility to sell electrical energy on a high price) it is different of thermal energy peak.

## 2. SENSITIVE HEAT STORAGE

In thermal storage systems that are using sensitive heat, storage media could be: liquid, (water, oil, melted salts, etc.) or solid (rocks, minerals, ceramic, etc.) Hasnain, (1998). Stored heat ( $Q$ ) (1.1) is direct proportional with used media weight ( $m$ ), average heat specific mass of used media at constant pressure ( $c_p$ ) and temperature difference ( $\Delta T = T_f - T_i$ ) between final state ( $T_f$ ) and initial state ( $T_i$ ).

$$Q = \int_{T_i}^{T_f} m \cdot c_p dT = m \cdot c_p \cdot (T_f - T_i) = m \cdot c_p \cdot \Delta T \quad (1.1)$$

$Q$  = the amount of stored heat, kJ

$m$  = storage media weight, kg

$c_p$  = heat specific mass, average, of storage media,  $\frac{\text{kJ}}{\text{kg} \cdot \text{K}}$

$T_i$  = initial temperature of storage media, K

$T_f$  = final temperature of storage media, K

Increasing the temperature of media storage will grow the sensitive stored heat. We want to have a high specific heat, establishment on long term in thermal cycle and a reduced price [Hasnain, (1998)], this could be reported to kg or to kWh<sub>th</sub> of thermal stored energy. Considering that mass ( $m$ ) is the product between density ( $\rho$ ) and volume ( $V$ ) (1.2), a huge mass of stored

media could represent a huge volume, which increase investment into the tank and also in thermal insulation of it, increasing at the same time the surface of occupied filed.

$$m = \rho \cdot V \quad (1.2)$$

where:  $\rho$  = density,  $\frac{kg}{m^3}$ ;  $V$  = volume,  $m^3$

Storage media should be a good thermal conductor, so it should have an high thermal conductivity ( $\lambda$ ), to allow an fast heat transfer during charge/discharge process.

Therefore, is a need to choose storage media having high values for:

- density ( $\rho$ );
- specific heat mass, average, of storage media ( $c_p$ );
- stored heat per volume unit (storage density of thermal energy) ( $\frac{Q}{V}$ );
- thermal conductivity ( $\lambda$ ).

Other characteristics that we chase when we are choosing media used in storage systems:

- stable at working temperatures;
- low corrosion in contact with materials;
- low price;
- high degree of marketing;
- low toxicity, non-explosive and environmentally friendly.

From equations (1.1) and (1.2) we obtain (1.3) și (1.4):

$$Q = \rho \cdot c_p \cdot V \cdot \Delta T \quad (1.3)$$

$$\frac{Q}{V} = \rho \cdot c_p \cdot \Delta T \quad (1.4)$$

where:  $\frac{Q}{V}$  – stored heat per volume unit,  $\frac{kJ}{m^3}$ , or, divided by 3600,  $\frac{kWh_t}{m^3}$ .

The product between  $\rho$  and  $c_p$ , is called specific volumetric heat (C) and represents the required quantity of heat needed by one cubic meter to increase its temperature by one Kelvin degree.  $\frac{kJ}{m^3 \cdot K}$ .

$$C = \rho \cdot c_p \quad (1.5)$$

Therefore, storage density of thermal energy is linked to the specific volumetric heat (C), which characterized the storage media properties from the point of view of heat storage and  $\Delta T$  (1.6):

$$\frac{Q}{V} = C \cdot \Delta T \quad (1.6)$$

In sensitive heat storage applications, the energy is stored by changing the storage media temperature used like water, air, oil, rocks bricks, sand or soil.

Any storage media has its own advantages and disadvantages, however the greatest continues to be water, because has a low price and a high specific heat. Yet at over 100 °C temperatures, are used oils, melted salts and liquid metals, etc. Into heating applications of air are used type materials „rock bed” [Sharma, ș.a. (2009)].

### 3. THERMAL STRATIFICATION

Observing density variation with temperature (Figure 3.1) it can be notice that when the temperature is raising, value of density is dropping, therefore, into one tank, areas of low density (which have high temperature) will be situated on top of the tank, while at its base will be the one with higher density (and low temperature). This separation is natural, and between those two extreme areas will take shape a third area, called thermocline (Figure 3.2). Thermal stratification is much more efficient if this third area has a small stretch. This thing happens when are not outside factors (like the mixing into tank of the storage media). In this way will be formed, two tanks of constant temperatures, but different; The separation being made by the thermocline, which will have a very temperature gradient high (Figure 3.2.a). In case we have external disturbing factors, thermal stratification is losing its efficiency, also thermocline will have a higher thickness and a greater weight in the total fluid volume (Figure 3.2.b).

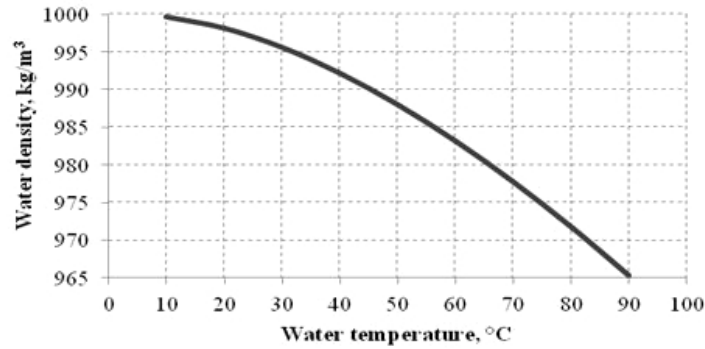

Figure 3.1. Variation of water density with temperature (at atmospheric pressure)

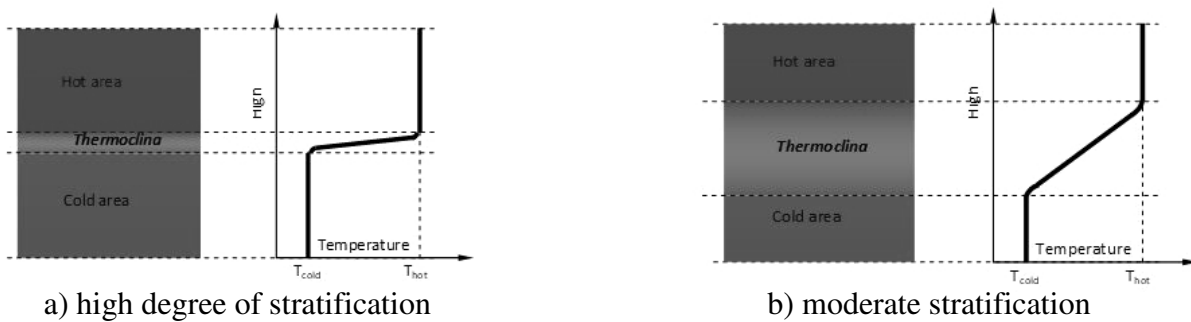
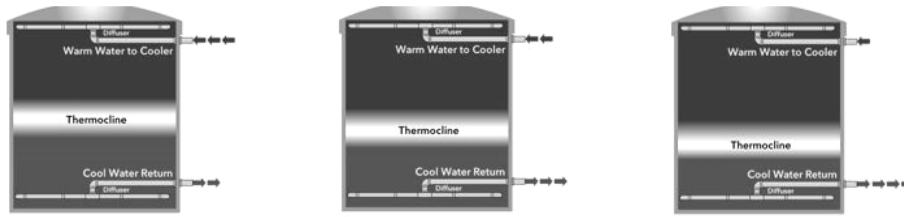

Figure 3.2. Thermal stratification and axial distribution of temperature in the tank.

Diffusion systems of fluid into the heat storage should be designed and located such that may influence as little as possible thermal stratification, therefore the working fluid should have an laminar flow regime or at most transient.

Charge/discharge of the storage system takes in consideration the thermal stratification, such that, regardless of whether the tank is for heat or cold accumulation, the hot fluid is inserted at the top of the battery, and the cold on the bottom of it.

The storage system involves three stages: charge, storage and discharge. The tank has 3 diffusion slots both to introduce the fluid into the tank and to remove from it. In case of heat storage, during charging the tank (Figure 3.3.a), the hot fluid (hot water) is taken over from the heat source (for example: thermal engine which works in cogeneration) and scattered (introduced) in the battery at the top diffusion system, while the downstream diffusion system aspirates the cold fluid (cold water) from the battery and drains it out of it, from the battery and drains it out of it. During tank discharge (Figure 3.3.b), the cold fluid is taken from the circuit and inserted into the battery through the slots located at the bottom of the battery. In the same time, cold fluid is pulled, with the help of pumps, through the slots situated at the top of the battery and drained out, being sent to the consumer.



a) charging of heat battery

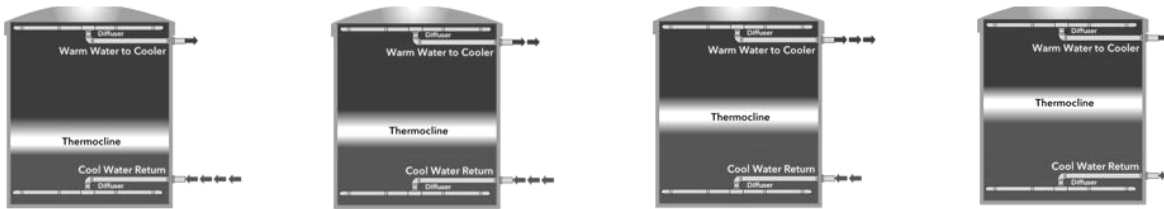

b) discharging of heat battery

Figure 3.3. Discharging and charging of heat [http://pacifictank.net]:

#### 4. LATENT HEAT STORAGE

Latent energy storage involves the following phase changes: solid-solid (dipping; passing from one crystalline state to another), solid-liquid (melting), solid-gas (sublimation) and liquid-gas (vaporization). Practically, in the solid-solid version, the materials do not turn into a liquid state under normal conditions, they just soften or harden; it has been observed that they have transition temperatures and latent fusion heat suitable for thermal storage applications. Promising materials are organic solid solutions of pentaerythritol (melting point 188 °C, latent fusion heat 323 kJ/kg), pentaglycerol (melting point 81 °C, latent fusion heat 216 kJ/kg), Li<sub>2</sub>SO<sub>4</sub> (melting point 578 °C, latent fusion heat 214 kJ/kg) and KHF<sub>2</sub> (melting point 196 °C, latent fusion heat 135 kJ/kg) [Garg, (1985)].

In Figure 4.1 graphically plot the temperature chart – specific enthalpy (specific thermal power) for ice-water-steam at atmospheric pressure, highlighting the constant temperature thresholds when changing the phase and the amount of latent heat of melting/solidification and si evaporation / condensation.

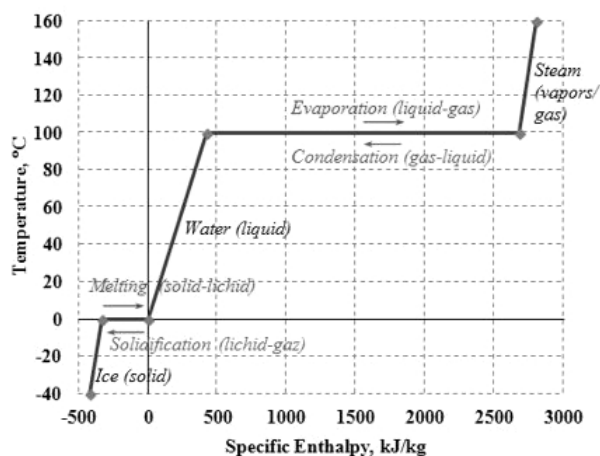

Figure 4.1. Temperature chart – Specific enthalpy (specific thermal power) for ice-water-steam at atmospheric pressure

## 5. CONCLUSIONS

The concept of energy storage has been in place for years, but, has recently become a research topic due to rapid technological progress in recent years. The main reasons for research and development of storage systems are:

- the mismatch between demand and energy production;
- using intermittent sources to cover energy demand;
- high fluctuations in demand for thermal energy over short periods.

Thermal energy storage systems can be classified into three major categories: a) energy storage systems in the form of sensitive heat, b) energy storage systems in the form of latent heat and c) Heat storage systems in the form of chemical reactions.

Of the three categories of storage systems, sensitive ones are mature from a technological point of view, are integrated and used around the world (For example: in Romania, cogeneration plant CET Oradea has a heat accumulator, the storage medium is hot water at 90 ° C, water being chosen due to its good thermodynamic properties and reduced cost).

The usefulness of the heat accumulator is to use the stored energy to cover the thermal load peaks, resulting in fuel savings by reducing the peak boiler service life and optimally charging power generation systems.

Water is a good storage medium because it is cheap and has a high specific heat; however, at over temperature of 100 °C, oils are used, molten salts and liquid metals. By increasing the storage medium temperature, the amount of stored heat is also increased.

Latent heat storage systems using phase change storage media offer high energy density and have the potential to keep heat as a latent heat of fusion at constant temperature, which allows large volumes of energy storage for small volumes. The main advantages of systems using phase shift storage media are: a) high capacity of heat accumulators, relative to the storage media mass, compared to those of heating systems that use sensitive heat and b) a low operating temperature range. Their main drawback is given by the large volume variation specific to the phase change.

Thermo-chemical storage systems, that has an very high potential in depositing heat, can be used to storage and discharge on large periods of, with small losses. Reversible chemical interaction that appears between reactive components of materials or chemical species are essential into storage and thermal energy recovery in this process called thermo-chemical storage. Unfortunately, applications using materials used to store the thermo-chemical energy are at the stage of the laboratory prototype.

## 6. AKNOLODGEEMENT

This work was supported by a grant of the Romanian Ministry of Research and Innovation, CCCDI – UEFISCDI, project number PN-III-P1-1.2-PCCDI-2017-0404 / 31PCCDI/2018, within PNCDI III

## References

- [1] Abhat, A. (1983). Low temperature latent heat thermal energy storage: heat storage materials. *Solar energy*, 30(4), 313-332.
- [2] Cenușă, V. E., Darie, G., Tuțică, D., Norișor, M., Alexe, F. N., & Mușat, C. M. (2016). Energetic and exergetic analysis of Rankine cycles for solar power plants with parabolic trough and thermal storage. *Renewable Energy and Environmental Sustainability*, 1, 10.
- [4] Dieckmann, J. H. (2006). Latent heat storage in concrete. University of Kaiserslautern, Germany. (<http://www.eurosolar.org>)
- [5] Fleischer, A. S. (2015). *Thermal energy storage using phase change materials: Fundamentals and applications*. Springer.
- [6] Garg, H.P., Mullick, S.C., Bhargava, A.K. (1985). *Solar Thermal Energy Storage*. Dordrecht, Holland: D. Reidel Publishing Co.
- [7] Giuliano, S., Buck, R., & Eguiguren, S. (2011). Analysis of solar-thermal power plants with thermal energy storage and solar-hybrid operation strategy. *Journal of Solar Energy Engineering*, 133(3), 031007.
- [8] González-Roubaud, E., Pérez-Osorio, D., & Prieto, C. (2017). Review of commercial thermal energy storage in concentrated solar power plants: Steam vs. molten salts. *Renewable and Sustainable Energy Reviews*, 80, 133-148.
- [9] Hagen, T. (2016). TES Tanks: When Theoretical Design Parameters Meet the Real World. The International District Energy Association (IDEA2016). 107th Annual conference & trade show, St. Paul, MN, June 20-23 (<https://www.districtenergy.org/>).
- [10] Haller, M. Y., Cruickshank, C. A., Streicher, W., Harrison, S. J., Andersen, E., & Furbo, S. (2009). Methods to determine stratification efficiency of thermal energy storage processes—review and theoretical comparison. *Solar Energy*, 83(10), 1847-1860.
- [11] Hasnain, S. M. (1998). Review on sustainable thermal energy storage technologies, Part I: heat storage materials and techniques. *Energy conversion and management*, 39(11), 1127-1138.
- [12] Herrmann, U., Geyer, M. and Kearney, D. (2006). Overview on thermal storage systems. Workshop on Thermal Storage for Trough Power Plants. FLABEG Solar International GmbH.
- [13] Iftime, V., Constantinescu, M., Pascaru, D. (2016). Încălzire urbană eficientă. COGEN, Forum Chișinău, 23 mai 2016 (<http://cogen.ro/wp-content/uploads/2016/05/6.-Elsaco-Prezentare-Forum-COGEN-Chisinau-23.05.2016-RO.pdf>)
- [14] Johnson, M., Vogel, J., Hempel, M., Dengel, A., Seitz, M., & Hachmann, B. (2015). High temperature latent heat thermal energy storage integration in a co-gen plant. *Energy Procedia*, 73, 281-288.
- [15] Johnson, M., Vogel, J., Hempel, M., Hachmann, B., & Dengel, A. (2017). Design of high temperature thermal energy storage for high power levels. *Sustainable Cities and Society*, 35, 758–763.
- [16] Osuna, R., & Fernández, V. (2001). 10 MW solar thermal power plant for southern Spain. Report no. NNE5/1999/356. E-41018 Sevilla: Solúcar SA, Avda. de la Buhaira 2.
- [17] Sharma, A., Tyagi, V. V., Chen, C. R., & Buddhi, D. (2009). Review on thermal energy storage with phase change materials and applications. *Renewable and Sustainable energy reviews*, 13(2), 318-345.
- [18] Sharma, S. D., & Sagara, K. (2005). Latent Heat Storage Materials and Systems: A Review. *International Journal of Green Energy*, 2(1), 1-56.
- [19] Wittmann, M. Molten Salt Systems - Higher thermal efficiencies by using salt instead of oil.
- [20] [http://www.dlr.de/sf/en/desktopdefault.aspx/tabid-10647/18795\\_read-44147/](http://www.dlr.de/sf/en/desktopdefault.aspx/tabid-10647/18795_read-44147/)
- [21] <http://mou-kraftvarme.dk/vort%20v%C3%A6rk.html>
- [22] <http://pacifictank.net/tank-services/tes-tanks/>
- [23] <http://www.araner.com/blog/thermal-accumulation/>
- [24] <http://www.archimedesolarenergy.com>
- [25] <https://www.dntanks.com/news/construction-update-baytown-tx/>

# CORRECTION OF POLLUTION EMISSIONS MEASUREMENTS ON FUEL COMBUSTION

Ion Iordache, Elena Pop\*, Lucian Mihăescu\*,

\*University POLITEHNICA of Bucharest, Faculty of Mechanical and Mechatronics Engineering, Splaiul Independentei nr. 313, sector 6, Bucuresti 060042 Romania

## ABSTRACT

The Flue Gas Analyzers perform an operation under the condensation of water vapor conditions, or otherwise expressed, the measurements comprise the composition of the dry flue gases. The difference between the value of a component measured in the dry flue gases and the reality assumed in the wet flue gases is even higher as the fuel is wetter. This category includes young coal, but also solid biomass of all categories. The paper approach the issue of the thermodynamic corrections needed to be performed on the measured data for minimizing the deviations.

## 1. CORRECTION OF EMISSION DATA FOR MOISTURE

The presence of moisture in a gas stream takes up space that would otherwise be occupied by pollutant, so the pollutant concentration expressed on a dry gas basis will always be higher than if it were expressed on a wet gas basis [3]. In the case of measurements of the combustion flue gas components, the flue gases are considered to be dry, the measuring apparatus allowing condensation of the water vapor in the flue gases.

In this case, the dry flue gases will have a certain temperature, which in fact is the saturation temperature of the water vapors, corresponding to their partial pressure.

For normal conditions, thermodynamic parameters are marked with  $p'_0$ ,  $V_0$  and  $T_0$ , where:  $p'_0$  is the partial pressure of the components in the flue gases under normal conditions;  $V_0$  and  $T_0$  represent the volume and the temperature under normal conditions.

The relationship between the parameters will be expressed by the relation:

$$p'_0 V_0 = \frac{m}{\mu} RT$$

where:  $m$  is the mass of pollutant;

$\mu$  is the molar mass of that pollutant.

For measurement requirements, it can be write the relationship:

$$p'V = \frac{m}{\mu} RT$$



where:

$p'$  is the partial pressure of the pollutant in the flue gas under the conditions of the measurements;

$V$  is the volume of dry gas under the conditions of the measurements.

Considering  $C$  the pollutant concentration, results:

$$\frac{m}{V} = C^m \text{ and } \frac{m}{V_0} = C^c,$$

where the ratio of the corrected concentrations  $C^c$  to the measured ones  $C^m$  results:

$$\frac{C^c}{C^m} = \frac{p'_0 \mu}{RT_0} \cdot \frac{RT}{p' \mu} = \frac{p'_0}{p'} \cdot \frac{T}{T_0}$$

Thus:

$$C^c = C^m \cdot \frac{p'_0}{p'} \cdot \frac{T}{T_0}$$

Considering  $\frac{p'_0}{p'} = \frac{p_0}{p}$ , in the end it comes to:  $C^c = C^m \cdot \frac{p_0}{p} \cdot \frac{T}{T_0}$

where:

$p_0$  - is the normal pressure;

$p$  - is the pressure before burning.

Another method of correcting a component in the flue gases can also be achieved with the following relationship:

$$C^c = C^m \frac{V_{gu}}{V_{gu} + V_{H_2O}},$$

where  $V_{H_2O}$  is the moisture content of the flue gases, calculated according to the components of the dry gas analysis with the relation:

$$V_{H_2O} = 0,112H^i + 0,01242W_t^i + 0,00161xV_a^0, m_N^3 / kg$$

where  $x$  is the humidity of the air. For steam spraying, its share/participation will also be included

## 2. CORRECTION BASED ON OXYGEN CONCENTRATION

The measured concentration can be expressed by:

$$C^m = \frac{m}{V_{gu}} = \frac{m}{V_{gu}^0 + (\lambda_m - 1)V_a^0}$$

The corrected concentration under standard conditions can be expressed by:

$$C^c = \frac{m}{V_{gu}^{st}} = \frac{m}{V_{gu}^0 + (\lambda_{st} - 1)V_a^0}$$

where :

$V_{gu}^{st}$  - volume of dry gas for  $\lambda = 1$  (stoichiometric);

$V_a^0$  - volume of dry air for combustion of one kilogram of fuel with  $\lambda = 1$  (stoichiometric);

$\lambda_m$  - the excess air coefficient in the measurement conditions;

$\lambda_{st}$  - the excess air coefficient under combustion conditions.

From previous relationships, it follows:

$$\frac{C^c}{C^m} = \frac{m}{V_{gu}^0 + (\lambda_{st} - 1)V_a^0} \cdot \frac{V_{gu}^0 + (\lambda_m - 1)V_a^0}{m}$$

or

$$\frac{C^c}{C^m} = \frac{V_{gu}^0 + (\lambda_m - 1)V_a^0}{V_{gu}^0 + (\lambda_{st} - 1)V_a^0} = \frac{1 + (\lambda_m - 1)\frac{V_a^0}{V_{gu}^0}}{1 + (\lambda_{st} - 1)\frac{V_a^0}{V_{gu}^0}}$$

Considering the approximation that can be made:  $V_a^0 = V_{gu}^0$ , results:

$$\frac{C^c}{C^m} = \frac{\lambda_m}{\lambda_{st}}$$

where:

$$\lambda_m = \frac{21}{21 - O_2^m} \quad \text{and} \quad \lambda_{st} = \frac{21}{21 - O_2^{st}}$$

In this situation, it follows:

$$C^c = C^m \frac{\lambda_m}{\lambda_{st}} = C^m \frac{21}{21 - O_2^m} \cdot \frac{21 - O_2^{st}}{21} = C^m \frac{21 - O_2^{st}}{21 - O_2^m}$$

If there is a reference oxygen concentration, a correction will also be made with the already generalized relationships in the literature.

### 3. CONCLUSIONS

The paper presents considerations and calculation relationships to correct the measurements of flue gas components in the combustion processes for real conditions of moisture and oxygen concentration.

#### References

- [1] I. Iordache, I. Oprea, L. Mihăescu, T. Prisecaru, E. Popa, "*Thermal nitrogen oxides emissions from fuel combustion*", Rev. Roum. Sci. Techn. – Électrotechn. et Énerg., 55, 1, p. 100–108, Bucharest, 2010
- [2] E. Popa, I. Iordache, "*Dynamics of nitrogen-bound fuel conversion to nitrogen oxides by biomass combustion*", Revue Roumaine des Sciences Techniques, Serie Electrotechnique et Energetique, Tome 52,1 2007, Ed. Academie Roumaine, ISSN: 0035-4066
- [3] Air Emissions Monitoring Guidance Note #3 (AG2), Revision3-published September 2017, ©Environmental Protection Agency Johnstown Castle Estate Wexford, Ireland, pg 69

# **ENERGY EFFICIENCY OF BUILDINGS – LEGISLATION IN THE REPUBLIC OF SERBIA**

dr Miodrag Kovačević<sup>1</sup>, dr Ivan Tasić

Technical College of Applied Sciences in Zrenjanin, Republic of Serbia  
University of Novi Sad Technical Faculty "Mihajlo Pupin" Zrenjanin, Republic of Serbia

## **ABSTRACT**

The paper will present legal solutions in the Republic of Serbia related to the energy efficiency of facilities in the sense of the Law on Energy and the Law on Planning and Construction of Facilities of the Republic of Serbia and applicable regulations and standards in the subject area. Special attention will be paid to the preparation of documentation for the construction of new facilities, but legal solutions will be presented to increase the energy efficiency (EE) of existing facilities. The energy efficiency (EE) of projects for the construction of new facilities should be identified as a primary objective and with the application of cost-effective measures and methods for increasing energy efficiency (EE) through the use of renewable energy sources (RES) and their application in facilities or technical and technological systems that are being built together with facilities lighting, water supply, heating water, heating, cooling, ventilation and air conditioning systems, etc.).

## **1. INTRODUCTION**

Increasing the quality of life and the development of new technologies has also increased human energy needs, which are largely ensured by combustion of fossil fuels (oil, coal, natural gas, etc.). For the needs of households in the Republic of Serbia, thermal energy is mainly obtained by transforming the chemical energy of a fuel (combustion) into heat energy. In coal-fired power plants, about 60% of total electricity is generated. The disadvantages of using fossil fuels are their limited quantity, and accelerated consumption, while combustion products significantly pollute the environment. In the process of vigorous oxidation of fossil fuels as combustion products, water, carbon dioxide, hydrocarbons and other materials contained in fuel appear, and they represent significant potentials in terms of pollution of the environment, acid rain, and global warming. In order to solve these problems, the decisive role may be to reduce the use of fossil fuels in the process of obtaining other energy resources that are used in households as well as in the industry.

Measures that can significantly reduce the use of fossil fuels can be classified in several areas:

1. education, informing and combining incentive measures by state authorities of the Republic of Serbia, drafting laws, regulations and standards;
2. the use of renewable energy sources to the maximum extent possible;
3. development and use of new environmentally friendly combustion and fuel technologies;
4. increasing energy efficiency and
4. energy saving measures. [1]

By applying these measures to the maximum possible extent, by combining them or by determining the balance between the measures and real needs, it is possible to achieve the

---

<sup>1</sup>Miodrag Kovacevic, Djordja Stratimirovica 23, 23 000 Zrenjanin, Republic of Serbia,  
+ 381 63 564 125, miodrag.kovacevic@vts-zr.edu.rs

rational effects of the degree of energy efficiency of the appropriate systems for energy use in building and industry. One of the many systems that requires an increase in the rationalization of energy consumption, given the enormous increase in the number of inhabitants, is also the building sector. According to the report of the Economic and Social Committee of the United Nations states that the world's population from the current population of nearly 7.6 billion increase to 8.6 billion by 2030, a number of people on Earth will rise to 9.8 billion by 2050 and about 11 , 2 billion by 2100. The number of people on Earth every year increases by 83 million people. Such a trend will continue, despite the fact that since the 1960s, fertility has been continuously decreasing.

The concept of energy efficiency implies a set of measures that are undertaken in order to reduce energy consumption, which does not undermine the working and living conditions. It is necessary to conserve energy consumption to the minimum possible while maintaining or increasing the level of comfort and comfort. It should be noted that there is a significant difference between energy efficiency and energy saving. Energy saving implies certain disclaimers, while efficient use of energy leads to an increase in quality of life.

## **2. ENERGY EFFICIENCY OF BUILDINGS THE REPUBLIC OF SERBIA**

The negotiations on the accession of the Republic of Serbia to the European Union, which include 35 thematic Chapters, are under way, until April 2018, the Republic of Serbia opened 12 out of 35 chapters. The screening process (Explanatory and Bilateral Screening) began in September 2013 and was completed by the end of March 2015. In the current process of negotiation, it has been shown that in many hapters Serbian legislation is largely in line with EU legislation. The disadvantage is the application of laws and accompanying regulations in practice. For the Energy Chapter, a major problem will be the application of the provisions of the Directive on the limitation of emissions of certain air pollutants from large combustion plants and the Industrial Emissions Directive, which additionally limits the emissions of air pollutants from large thermal power plants. These provisions directly condition the operation of some blocks of our thermal power plants, so it is necessary as soon as possible to begin the reconstruction and modernization of these thermocouples. The biggest problems are expected in Chapter no. 27 Environment where it is estimated that bringing this area into harmony with EU law could result in costs of € 13-15 billion, which the Republic of Serbia does not have to invest in addressing environmental issues. In Chapter no. 15 Energy is stated in the report on the conducted screening that it is necessary to make more efforts to resolve the requirements in this area in the process of harmonization with EU legislation and norms.

One of the strategic goals of the EU's energy policy until 2020, which promoted the so-called policy 20-20-20, which implies: reducing CO<sub>2</sub> emissions by at least 20% in relation. 1990; increase of energy efficiency by 20%; raising the share of energy produced from renewable energy sources to 20% in total energy consumption in the EU. Realizing this policy will be a major challenge for the Republic of Serbia. Energy efficiency is our biggest energy resource that we need to activate and which we have not yet started to use in an adequate way. One of the good approaches for improving the energy efficiency of a state is the existence of state coercion and certain incentive measures.

A typical example of the state's coercion is the Netherlands, where so-called voluntary contracts were imposed in the 1970s after the oil crisis, which obliged companies to work on energy efficiency. Volunteerism was just that there was a choice: either the obligation would

be signed that each year concrete investments in energy efficiency measures would be paid, or a high tax on the use of energy would be paid. By combining this and other measures and by rigorous control of the implementation of the prescribed measures, it has been achieved that the consumption of energy had a very slight increase in relation to a significant increase in national income. In many countries, legislation is enacted or envisaged, requiring citizens to apply certain measures to improve energy efficiency, such as, for example, the measure of a gradual ban on the use of hot bulbs in households for the benefit of energy-efficient lamps. The optimal development of the energy sector in the region of Southeastern Europe and the Republic of Serbia within it, from the aspect of sustainability (which includes limited sustainability in circumstances with natural disasters, the impact of fire, floods, earthquakes and similar disasters) should start from real needs, technological progress, as well as economic and environmental limitations. Improvement and affirmation of the profession in which energy connective tissue remains the basic need. Through this interconnection of intense energy needs and modern technologies (which, due to attractiveness, dominate over conventional technologies) with sustainable development, the energy sector remains equally vital and profitable and current.

Energy Development Strategy of the Republic of Serbia until 2025 with projections to 2030, is made by considering the existing structure of the energy sector and is based on the energy balance of 2010 as the base year, assess the energy needs of the Republic of Serbia for the period up to 2030, based on projections from the Strategy and Policy Development of the Republic of Serbia Industry from 2011 to 2020, available energy resources, including the potential of renewable energy sources (RES), population reduction projections, the Spatial Plan of the Republic of Serbia with respect to all obligations of the Republic of Serbia arising from the Agreement on energy community.

In 2006, the Republic of Serbia became a member of the Energy Community by ratifying the Agreement on its establishment in accordance with its main goals in the field of energy - ensuring safe energy supply, increasing the overall efficiency of the energy sector, protecting the environment and developing renewable energy sources (RES), and the general goal of joining the EU. Following the harmonization of time limits when applying the specific provisions of the EU Directive in domestic legislation (Directive 2006/32 / EC, Directive 2010/31 / EU and Directive 2010/30 / EU) in domestic legislation, the provisions of those Directives are implemented in two laws Republic of Serbia:

1. Law on Efficient Use of Energy;
2. Law on Planning and Construction and
3. Through the accompanying by-law regulations and three Energy Efficiency Action Plans of the Republic of Serbia.

In October 2015, at the meeting of the Ministerial Council of the Energy Community, the Republic of Serbia has accepted the energy efficiency obligations that apply to the EU, ie the obligation to implement the new Directive 2012/27 / EU. Under this directive, the Energy Community requires all members to adopt savings mechanisms in distribution and retail energy companies, to promote efficiency in heating and cooling systems as well as cogeneration systems.

On the basis of previously defined goals and fulfillment of assumed obligations under the Treaty establishing the Energy Community, on the proposal of the Ministry of Mining and Energy, on 15 March 2013, the National Assembly of the Republic of Serbia adopted the Law

on Efficient Use of Energy in the Republic of Serbia. The main goal of the adopted law is to provide a rational and sustainable use of energy, thus contributing to more secure supply, increasing the employment rate, the competitiveness of the economy and the environment. The law introduces the Energy Management System (SEM) as one of the key mechanisms, but it also predicts that all devices that directly or indirectly affect the energy consumption are labeled during the placement on the market. In order to implement this legal solution deriving from Directive 2010/30 / EU, the Government of the Republic of Serbia has adopted two Regulations, and the Ministry of Mining and Energy has adopted nine regulations on the labeling of energy efficiency of household appliances.

Applying the First Action Plan for Energy Efficiency in the period 2010-2012, savings of around 81.5% of the planned savings have been achieved, which is satisfactory, bearing in mind that the main mechanisms for achieving savings have not yet been legally adopted and in force. The second action plan for the period 2013-2015 predicted savings at the level of 3.5% of domestic final energy consumption in 2008 (0.2952 Mtoe). With this action plan, the building sector has been recognized as one of the largest energy consumers, and is therefore expected to achieve 0.1387 Mtoe within the household sector and the public commercial sector (where buildings are prevalent), representing about 35% of the total planned savings for 2015. By the conclusion of the Government of the Republic of Serbia on 29 December 2016, the Third Action Plan for Energy Efficiency of the Republic of Serbia for the period 2017 - 2018 was adopted. The Law on Planning and Construction stipulates that buildings depending on the type and purpose must be designed, constructed, used and maintained in a way that ensures the prescribed energy properties, which are determined by issuing certificates of energy properties of buildings, issued by an authorized organization, through this law the provisions of Directive 2010/31EU on the energy characteristics of buildings are transferred to the legal system of the Republic of Serbia. That Directive 2010/31EU has been implemented in detail through the following documents:

1. Regulations on the energy efficiency of buildings;
2. Regulations on the conditions, content and method of issuing certificates on the energy properties of buildings;
3. Regulations on the conditions, program and method of passing the professional exam in spatial and urban planning, preparation of technical documentation and construction and
4. Regulations on the conditions and procedure for issuing and revoking the license for the responsible urban planner, designer, contractor and responsible planner. [2]

According to the method of heating the buildings in the Republic of Serbia we can make the following division: 26% of the total surface of the buildings is heated from the district heating system and local boiler rooms with central heating (14% from the district heating system and 12% from the local boiler rooms), 14% from the electricity system, 10% uses natural gas as an energy source and about 50% of the total surface uses for heating solid fuels in local furnaces (coal, firewood, agricultural biomass, waste, etc.). The average annual specific energy consumption for buildings heated from the district heating system and local boiler plants is as follows:

1. for residential buildings 171 kWh/m<sup>2</sup>, and for non-residential buildings 194 kWh/m<sup>2</sup> i
2. for the preparation of hot water in residential buildings 55 kWh/m<sup>2</sup>, and in non-residential buildings 12 kWh/m<sup>2</sup>.

The average specific heat consumption for heating and hot water preparation in residential and non-residential buildings is reduced to 1 m<sup>2</sup> of net residential area of 228 kWh/m<sup>2</sup>. The average specific energy consumption for heating objects using other heating methods is:

1. for electrically heated objects 130 kWh/m<sup>2</sup>;
2. for natural-heated objects 230 kWh/m<sup>2</sup> and
3. for buildings heated by local furnaces to solid fuel 57 kWh/m<sup>2</sup>.

The number of households that heat on electricity is about 15% of the total, and only for heating is consumed 24% of the total electricity consumption in all households. The residual electricity in households of 10,500 GWh is used for the following purposes:

1. lighting - 735 GWh (7%);
2. storage boilers - 2,145 GWh (23%);
3. cookers and food preparation equipment - 3,150 GWh (30%);
4. washing machines and dishes - 893 GWh (8.5%);
5. refrigerators and freezers - 2,625 GWh (25%) i
6. for other needs - 952 GWh (6.5%).

The lag in energy efficiency in buildings in relation to European countries was observed even in the early 1990s, confirming this claim data on the average final energy consumption of 138 kWh/m<sup>2</sup> in residential buildings in the EU for thermal purposes. In Denmark, in buildings connected to district heating systems, the specific heat consumption for heating is 96 kWh/m<sup>2</sup>, and in facilities using fuel oil or gas 131 kWh/m<sup>2</sup> and 106 kWh/m<sup>2</sup>. In buildings built according to new regulations in Poland where the climate is much sharper and unfavorable than in Serbia, the specific energy consumption is 90-120 kWh/m<sup>2</sup>. In Sweden, located in the north of Europe where winter temperatures are extremely cold and long with a longer heating season, average consumption is 120 kWh/m<sup>2</sup>, and in newer buildings with the lowest energy consumption requirements of 60 - 80 kWh/m<sup>2</sup>. [4]

According to the Law on Efficient Use of Energy, the obligation of local self-government units (LGU) is to include in the tariff system for district heating services (as one of the elements for calculating the price of heating) the measured or actually delivered quantity of heat, and based on the Law on Energy Article 362), the Government of the Republic of Serbia shall adopt a methodology for determining the price of the end customer's supply of heat energy. Accordingly, the Ministry of Mining and Energy has prepared and the Government of the Republic of Serbia has passed a decree determining the methodology for determining the price of the end customer's supply of heat energy.

In accordance with the Law on Efficient Use of Energy, minimum energy efficiency requirements must be met by new and revitalized plants for the production of electricity and heat, electricity transmission systems, that is, systems for the distribution of electricity and heat, as well as systems for transport and distribution of natural gas, depending on the type and strength of these plants, or the size of the system.



Table 1: Basic data on centralized heat supply systems in the Republic of Serbia [3]

Data	Unit of measure	Quantity
Total number of apartments in the Republic of Serbia	-	2.943.401
Surface area in the Republic of Serbia	m <sup>2</sup>	199.204.252
Number of apartments with central heating installations	-	720.495
Number of apartments connected to the heating plant	-	481.660
The total area of dwellings connected to the heating plant	m <sup>2</sup>	28.143.552
Total area of other dwellings and business units connected to the heating plant	m <sup>2</sup>	8.852.993
Total area of apartments and business facilities connected to the heating plant	m <sup>2</sup>	36.996.485
The share of dwellings with central heating installations Compared to the total number of dwellings	%	24,5
The share of dwellings connected to the heating plant in relation to the total number of dwellings	%	16
Number of heating plants	-	292
Number of boilers	-	660
Boiler capacity	MW	5.506
Consumed power consumption	MW	5.486
Annual fuel consumption	toe	615.284
Length of the hot water network	km	1.250
Total number of substations	-	15.025
Number of substations in residential buildings	-	9.484

### 3. CONCLUSIONS

In the building sector in the Republic of Serbia, most of the energy is spent on heating the space, 24% of the final energy is consumed for heating. The consumption of heating energy at the Serbian level is twice as low as the average for Europe, which is somewhat expected if its geographical position is taken into account. Located in the south of Europe, Serbia has far more favorable climatic conditions, shorter and milder winters than the countries of northern Europe. Due to the extreme inefficiency in the consumption of heating facilities in the Republic of Serbia, this segment of consumption should be urgent. The most common reason is the worsening and energy inefficiency of the building envelope. With concrete reasons for energy inefficiency, it is relatively easy to determine the cost-effectiveness of investments in possible ways of their rehabilitation, and the choice of the appropriate solution for a particular facility already leads to a higher quality energy consumption for heating. Increasing energy efficiency does not only lead to more rational energy consumption. The impact on the environment is equally important. Reduced emission of harmful gases would create a healthier environment that would improve the quality of life.

### References

- [1] Miletić M., Lukić N., Use of Final Energy in Households in Serbia, (2011), 42nd KGH Congress
- [2] Handbook for Energy Managers for Building Energy Sector, United Nations Development Program (UNDP), Belgrade, June 2017.
- [3] Todorović M., Ristanović M., Efficient use of energy in buildings, University of Belgrade, 2015. Belgrade
- [4] <http://www.eea.europa.eu/>

# ENERGY EFFICIENCY OF THE RECEIVER OF SOLAR ENERGY IN THE TERRITORY OF THE REPUBLIC OF SERBIA

dr Miodrag Kovačević<sup>1</sup>, dr Ivan Tasić, dr Jasmina Pekez  
Technical College of Applied Sciences in Zrenjanin, Republic of Serbia  
University of Novi Sad Technical Faculty "Mihajlo Pupin" Zrenjanin, Republic of Serbia  
University of Novi Sad Technical Faculty "Mihajlo Pupin" Zrenjanin, Republic of Serbia

## ABSTRACT

The energy efficiency (EE) of the system for heating water from collector to accumulator solar boiler is in the range of 35 to 55 (%) depending on the performance of the collector, the materials used for the production of solar collectors and the manner of installation and maintenance. Low energy efficiency (EE) values refer to solar collectors that have poor design and thermal insulation characteristics. Such collectors, as a rule, have low values of absorption, and the heat emissivity values from the absorbent surface are significantly lower. Collectors that have such characteristics are collectors whose absorbers do not have good selective characteristics, therefore the value of the radiation emission coefficient is close to the value of the coefficient of absorption of radiation. This feature is directly influenced by the number and type of transparent coverings.

## 1. INTRODUCTION

Solar collectors are also tested for efficiency in conditions of equality of external air temperature and temperature of absorber - fluid in absorber (zero efficiency). Zero efficiency is not relevant for a serious assessment of the efficiency of the solar collector. For this type of estimation, the characteristic of the efficiency curve, curve (or equation) of the dependence of the energy efficiency of the collector on the relationship between the difference in the characteristic flux/absorber and ambient temperature temperatures and solar radiation is very important for this type of assessment.

The crucial feature for selecting a solar collector from the point of view of its efficiency is that efficiency that is valid for the operation of the solar collector in dynamic (real) working conditions. The amount of heat that can be used with 1 (m<sup>2</sup>) collector is about 900 (kWh). Vacuum heat collectors have considerably greater efficiency, which manifests significantly during colder periods. The energy efficiency (EE) of vacuum solar collectors is based on the thermal insulation of the absorber. The energy efficiency of the system for heating water with vacuum collectors is about 40 (%) higher than the system with flat plate solar energy transfer if one year is observed. The price of installation of vacuum collector systems is almost 50 (%) higher than the price of installation of systems with classical receivers of solar energy. Bearing in mind these properties, vacuum collector systems are recommended for enclosures in buildings where there is a continuing need for hot water, or where large quantities of hot water are required. [4]

The number of sunny hours in Serbia goes in average from a bit less of 2.000 hours (in the North) to more than 2.300 (in the South). It is a larger value than in the most European countries, but the solar potential is not used. The potential of solar energy presents 16,7% of overall usable potential of Renewable Energy Sources (RES) in Serbia. The energy potential

---

<sup>1</sup>Miodrag Kovacevic, Djordja Stratimirovica 23, 23 000 Zrenjanin, Republic of Serbia,  
+ 381 63 564 125, miodrag.kovacevic@vts-zr.edu.rs

of solar radiation is for about 30% bigger in Serbia than in Central Europe. The average daily energy of global radiation for a flat surface during winter period goes from 1,0 kWh/m<sup>2</sup> in the North and 1,7 kWh/m<sup>2</sup> in the South, and during summer season between 5,4 kWh/m<sup>2</sup> in the North and 6,9 kWh/m<sup>2</sup> in the South. The most favorable areas in Serbia record a great number of sunny hours, and the yearly ratio of real irradiation and overall possible irradiation is close to 50%. Serbia has one of the best solar resources in Europe. Solar radiation in average is bigger for about 40% of the European average. The lowest measured values of solar radiation in Serbia could be compared to the highest values in the countries leading in the use of solar radiation, such as Germany and Austria. For comparison, the average value of solar radiation for the German territory is around 1.000 kWh/m<sup>2</sup>, while for Serbia it is 1.400 kWh/m<sup>2</sup>. The number of sunny hours in Vojvodina goes from a bit less than 2.000 hours (Western part) up to 2.100 hours (Eastern part). According to "Valentin Energie Software – TSol Pro 4.5" the average annual value of global radiation for horizontal surface is between 1.294 kWh/m<sup>2</sup> on the North of AP Vojvodina and 1.350 kWh/m<sup>2</sup> on the South of Vojvodina, and 1.281 kWh/m<sup>2</sup> on the West and up to 1.294 kWh/m<sup>2</sup> on the East of Vojvodina. This shows that on the same source, the average yearly value of sun radiation over a horizontal area for the territory of AP Vojvodina is around 1.300 kWh/m<sup>2</sup>. The average daily energy of global solar radiation on horizontal surface at the territory of AP Vojvodina goes from 1,0 – 1,4 kWh/m<sup>2</sup> during January, and from 6,0 – 6,3 kWh/m<sup>2</sup> during July. At the territory of AP Vojvodina, the annual average of daily solar radiation energy on the surface leaned towards south under the angle of 30° results with 4,0 – 4,6 kWh/m<sup>2</sup>. [1]

## 2. ANALYSIS OF ENERGY EFFICIENCY OF SOLAR COLLECTORS

When examining the energy efficiency of solar collectors in dynamic operating conditions it has been established that the heat transfer factor on the efficiency of the receiver is significantly influenced by the effectiveness of the receivers and the mass flow of the working fluid. The heat transfer factor from the receiver, under the same test conditions, is higher in the absorber whose tubes are in the form of a serpentine than in the receiver whose pipes are of the absorber in the form of a pipe register. In the case of an absorber of the type of pipe register, the factor of the discharged heat from the receiver is increasing if the mass flow of the fluid increases. With this type of absorber, by increasing the distance between the absorber tube, the heat removal factor from the receiver decreases until the diameter of the absorber tube has a significant effect on the increase in the heat removal factor from the receiver.

In the case of an absorber whose tube is in the shape of a serpentine, the increase in flow affects the increase in the heat removal factor from the receiver. The heat removal factor has a higher value in the turbulent flow of the working fluid than in the laminar flow regime. The fluid flow regime can be influenced by an increase in the diameter of the tube of the absorber. By increasing the distance between the absorber tube, the heat removal factor decreases. The effectiveness of the receiver is in the function of constructive characteristics, and its mathematical form varies depending on the design of the absorber - that is, the concept of the performance of the absorber tube. By analyzing terms that define the effectiveness of the receiver, it can be concluded that all the parameters that depend on the construction of the receiver receivers for a particular receiver of solar energy, except for the convective loss coefficient that affects the thermal losses from the front - receiving side of the receiver and which depends on the inclination of the receiver, wind, temperature of the absorber and ambient temperature. Wind velocity and ambient temperature are climatic parameters, so the temperature of the absorber and, consequently, the thermal losses can be influenced by

regulating the flow of fluid through the absorption chambers - pipes. By increasing the mass flow of the working fluid, the temperature of the absorber decreases, thereby reducing the heat losses. In order to gain insight into the existing state of energy efficiency of flat heat receivers of solar energy on the market, a comparative analysis of 10 representative types of constructions has been carried out, which have been widely used in practice. The energy efficiency analysis was performed on the basis of the efficiency curve which is part of the project and certificate of the receiver of solar energy.

The general energy efficiency equation is given in the manufacturer's attestation and has a form suitable for graphic presentation of the type:

$$\eta = \eta_0 - a_1 \frac{\Delta T}{G} \quad (1)$$

Based on the consideration of the analyzed representative receiver constructions, it has been found that the receiver's efficiency varies from 45 to 75% at  $\Delta T / G$  of 0.05 K/m<sup>2</sup>W, depending on the design parameters. The results of the study show that thermal losses in different types of receivers are more dynamic than optical efficiency, and that these changes are caused by changing the value of the receiver's effectiveness.

Total receiver losses are the most influential on the receiver's effectiveness. They make heat losses from the front, rear and side sides of the receiver, with the influence of heat losses on the front of the receiver dominant. Thus, the specific loss of heat from the upper side of the receiver is directly dependent on the coefficient of convective heat transfer between the absorber and the transparency, the heat loss coefficient of radiation from the absorber to the transparency, and the temperature of the transparency and the total heat loss coefficient from the receiving side, that is, the coefficient of convective heat losses (from the banners) due to the wind and the heat loss coefficient by radiating the banner to the sky. The character of its change depends on the working conditions and the constructive parameters of the receiver and is consistent with the physical character of the change in the influence parameters. The coefficient of convective heat transfer between the absorber and the transparency increases by 23% with an increase in the temperature of the absorber from 40 to 100 °C (at the absorption coefficient of 0,95) and 29% (in the absorption coefficient of 0,10). The coefficient of convective heat transfer between the absorber and the transparency depends on the type of gas in the interface between the absorber and the transparency and the inclination of the receiver.

The coefficient of heat loss by radiation between the absorber and the transparency, in the case of a single transparency receiver, with an absorption coefficient of 0.95, increases with an increase in the absorber temperature from 40 to 100 °C by 53% - if there is no air flow and 43 % - at air velocity of 10 m/s. The total coefficient of heat losses from the receiving side of the receiver, in a calm air, and an increase in the temperature of the absorber from 40 to 100 °C , increase from 26,6% (in the absorption absorption coefficient of 0,95) to 24,5% apsorber absorption coefficient of 0,10). The coefficient of heat loss by radiating the banner to the sky increases with an increase in the temperature of the absorber and, consequently, the transparency by 18% at wind speeds of 0 m/s and 7,5% for wind speeds of 10 m/s, with an apsorber temperature rise of 40 to 100 °C, at a coefficient of absorption of the absorber of 0,95. The coefficient of convective heat losses from the windscreen transparency depends on the wind speed and the tilt of the receiver of the solar energy.

The practice has shown that at an absorber temperature of 40 °C the absorber turns about 60% of the received solar radiation into heat. By bringing the temperature of the absorber to the ambient temperature, it positively affects the reduction of both convective and heat loss due to radiation, and this can be achieved by regulating the mass flow of the working fluid. For the transfer of heat from the absorber to the working fluid, the constructive concept of the absorber is important, ie, the size of its contact surface with the working fluid and the way of achieving the connection of the absorber tube and absorbent plate, the coverage of the total surface of the absorber with the absorbent tubes and the conductive characteristic of the material of the absorber. On the other hand, we should aim to increase the coefficient of heat removal from the absorber, which depends on the effectiveness of the receiver and the mass flow of the working fluid.

By testing the efficiency of the solar energy receiver with steel, aluminum and copper absorber, thickness 0,15 mm, 0,30 mm and 0,60 mm, it was found that the receiver with a copper absorber was 0,6 mm had the highest energy efficiency value under the test conditions. By replacing the steel absorber with a thickness of 0,15 mm aluminum of the same thickness, the energy efficiency of the receiver increased by 17%. By replacing the aluminum absorber with a thickness of 0,15 mm - copper, the energy efficiency was increased by 6,5%. When the thickness of the absorber was increased to 0,3 mm, the replacement of the steel absorber with aluminum resulted in an increase in efficiency by 9,5%, and the replacement of the aluminum absorber with copper, increasing the efficiency of the receiver by 5%. By increasing the thickness of the absorber to 0,6 mm, the efficiency increased by 3% when the steel absorber was replaced by aluminum, and 1,5% when the aluminum absorber was replaced by copper. The receiver with an aluminum absorber with a thickness of 0,6 mm had the same efficiency as a receiver with a copper absorber with a thickness of 0,3 mm.

The increase in the value of the absorption coefficient of the materials of the absorber, under the conditions of the tests, with values of 80 W/Mk (steel) to a value of 380 W/mK (copper), results in an increase in the energy efficiency of the receiver by 13%. The dependence of optical efficiency on the coefficient of conduction (in W/mK) is defined by the expression:

$$\eta_0 = 0,553 + 7,824 \cdot 10^{-4} \cdot \lambda - 1,13 \cdot 10^{-6} \cdot \lambda^2 \quad (2)$$

and the dependence of the thermal loss coefficient of the coefficient of conduction by the expression:

$$a_1 = 4,07413 + 0,00502 \cdot \lambda - 7,325 \cdot 10^{-6} \cdot \lambda^2 \quad (3)$$

Determining the number of absorbent tubes on the absorption board, which causes an increase in the energy efficiency of the receiver, is reduced to the analysis of the distance between the absorption tubes. In this context, a better solution with a smaller distance between the pipes is better, as this increases the exchange surface and shortens the heat transfer path. Reducing the distance between the exchanger pipe is achieved by increasing the number of absorber tubes. The research found that the receiver with an absorber having 21 hoses has the highest value of efficiency, is the least distance between the tube, and hence the largest exchange surface, under the conditions of testing. The efficiency of the receiver of solar energy increases with the increase in the number of pipes of the absorber, so by changing the number of pipes from 4 to 21, the efficiency of the absorber by 21% is increased

for the investigated case, but the efficiency with the 16 pipe absorber is only 1% higher when the number of pipes increased to 21. The dependence of the change in optical efficiency on the number of absorber tubes is determined by the expression:

$$\eta_0 = 0,39427 + 0,04146 \cdot n - 0,00123 \cdot n^2 \quad (4)$$

and the dependence of the heat loss coefficient on the number of tubes of the absorber by the expression:

$$a_1 = 2,32296 + 0,36754 \cdot n - 0,01124 \cdot n^2 \quad (5)$$

$$a_1 = 5,66729 - 0,07151 \cdot l_{ta} + 0,00129 \cdot l_{ta}^2 \quad (6)$$

In the case of a receiver whose tube is a serpentine absorber tube, the energy efficiency is increased by 6%, by changing the mass flow rate from 0.9 [kg / min] to 1.66 [kg / min] under certain test conditions. The dependence of energy efficiency on the mass flow of the working fluid, for the receiver whose tube is the absorber in the form of a serpentine, is defined by the expression:

$$\eta = 44,18485 + 0,1303 \cdot m - 5,34848 \cdot 10^{-4} \cdot m^2 \quad (7)$$

Constant mass flow of working fluid causes an increase in the temperature of the outgoing fluid, which results in a decrease in energy efficiency due to increased heat losses. This is especially true when the medium temperature of the working fluid is higher than the ambient temperature. The carried out testing found that in order to increase the temperature of the outlet fluid from 25 to 70 °C, the efficiency decreased by 35% under precisely determined conditions of testing.

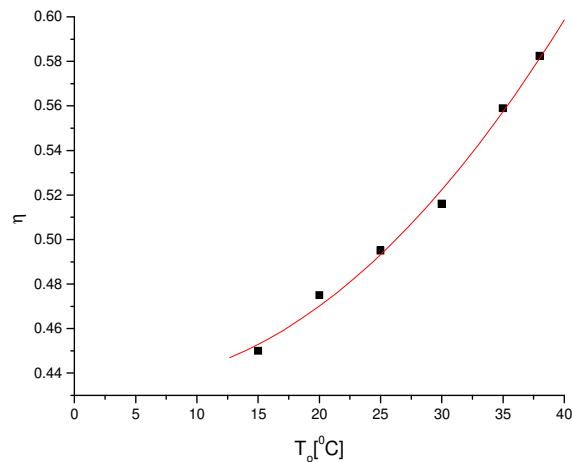

Figure 1: The dependence of solar collector efficiency on ambient temperature

### 3. CONCLUSIONS

The influence of the ambient air temperature change on the efficiency of the receiver was carried out under conditions with precisely determined test conditions where the ambient air temperature from 15 °C increased to 36 °C. The test found that the receiver's efficiency

was increased by 30%, which is the result of a decrease in the thermal losses of the receiver due to a decrease in the difference between the mean temperature of the working fluid and the ambient temperature. Based on the results of the research carried out on the type of fluid that shows the highest efficiency of the receiver, under precisely determined test conditions, it has been found that the working fluid - a mixture of water and ethylene glycol, with an ethylene glycol content of 16%, has a 0,8% higher efficiency than when a mixture of water with a propylene glycol content of 16% was used as the working fluid under the same test conditions. It has been found that the type of working fluid has a negligible influence on the energy efficiency of the receiver of solar energy.

The results of the performed tests of more favorable values of the basic structural characteristics from the aspect of energy efficiency can be applied to all types of structures with a tube-type absorber type.

The study found that:

1. Increasing the number of pipes of absorbers from 4 to 21 increases also efficiency up to 21%;
2. By replacing the steel absorber with a thickness of 0,15 mm with an aluminum absorber of the same thickness, the efficiency of the receiver by 17% was increased, and the replacement of the aluminum absorber with copper the same thickness increased the efficiency by 6,5% and
3. Energy efficiency was increased by 8.4%, while increasing the thickness of thermal conductivity 0.04 W/mK, from 10 to 60 mm) for the examined case of a flat receiver of solar energy.

Other constructive characteristics have negligible influence on the energy efficiency of the receiver of solar energy. For concrete cases of flat heat receivers of solar energy in exploitation, when it is not possible to change the constructive parameters, increasing the energy efficiency of the receiver can be achieved by regulating the mass flow of working fluid and accumulation - consumption.

Conducted studies of the effect of the change in the flow on the efficiency of the receiver of solar energy have been determined that:

1. By increasing the mass flow rate from 4 kg/min to 30 kg/min, the efficiency increased by 15,4% for the receiver with the absorber in the form of a tube register and
2. Increasing the mass flow from 0,9 kg/min to 1,66 kg/min, energy efficiency increased by 6% for the receiver whose tube is absorbent in the form of a serpentine.

## References

- [1] STUDY ON THE ESTIMATION OF OVERALL SOLAR POTENTIAL - SOLAR ATLAS AND THE POSSIBILITY OF "PRODUCTION" AND USE OF SOLAR ENERGY ON THE TERRITORY OF AP VOJVODINA, AP of Vojvodina, Provincial Secretariat for Energy and Mineral Resources, Novi Sad, 2011.
- [2] Pekez, J., Lambić, M., Grbić N., Comparative indicators of the influence parameters on the energy efficiency of solar collectors, Energy Technology, Vol. 3, No 1-2, 2006, 6-8, ISSN 1451-9070
- [3] Pekez, J., Lambić, M., Tasić I., Increasing the Energy Efficiency of Solar Collectors by Controlling the Mass Flow of a Working Fluid, Energy Technology, Vol. 2, No 3, 2005, 49-51, ISSN 1451-9070.
- [4] Lambić, M. et al., Energy Efficiency, Serbia solar, Zrenjanin, 2004.

# EXPERIMENTS ON THE ENERGY CHARACTERISTICS OF POULTRY MANURE

Gheorghe Lăzăroiu<sup>1</sup>, Lucian Mihăescu<sup>1</sup>, Ionel Pîșă<sup>1</sup>, Gabriel Negreanu<sup>1</sup>,  
Dana Ciupăgeanu<sup>1</sup>, Andrey Bondrea<sup>1</sup>, Viorel Berbec<sup>1</sup>, Victor Galbură<sup>2</sup>, Mihai Tîrșu<sup>2</sup>

<sup>1</sup>University Politehnica of Bucharest

<sup>2</sup>Power Engineering Institute of the Academy of Sciences of Moldova

## ABSTRACT

The paper presents the methodology for revealing the energy characteristics of poultry manure, collected from the storage facility of a chicken breeding farm. The collection of data on the possibility of its combustion for economic or ecologic-energy purposes point of views was considered. Six tests were performed, including technical analysis, elemental analysis, lower calorific value and ignition temperature.

## 1. INTRODUCTION

Poultry chickens can be regarded as a fertilizer but also as a possible polluter depending on the area and the amount of storage. Starting from ecological considerations, the issue of burning it is raised in an energy system with support from a fossil fuel. The chicken breeding technology requires a wood or straw bed, so that a manure and solid biomass mixture occurs when removing the waste.

## 2. METHODOLOGY

The research was performed on poultry manure collected from for a chicken farm in Moldova region (Romania), the bed being made of grain straw. The straws represent about 10-12 % of the total weight.

Figure 1 shows the appearance of the waste taken from the temporary warehouse located next to the production halls. It was taken into consideration that a burning recovery would appeal to the temporary storage facility.



*Figure 1: Waste appearance in the temporary storage facility*

---

<sup>1</sup> email: glazaroiu@yahoo.com.



The full energy features of the poultry manure include:

- technical analysis;
- elemental analysis;
- lower calorific value.

Six tests were run during the determinations to find the margin of dispersion of the elements defining the characteristics presented. The average bulk density of waste was 98 kg/m<sup>3</sup>. Table 1 presents the results of the technical analysis at the initial condition:

*Table 1 Results of technical analysis at initial condition*

Test \ Characteristic	I	II	III	IV	V	VI
Moisture, $W_t^1$ , %	36.1	35.6	37.2	38.1	39.1	40.3
Volatile, $V^1$ , %	50.2	48.8	47.4	46.5	45.3	44.6
Ash, $A^1$ , %	6.2	7.1	6.3	6.2	6.2	6.2
Fixed carbon, $C_f^1$ , %	7.5	8.5	9.1	9.2	9.4	8.9

Analyzing the volatile content, it is noted that they have a very high percentage of oxygen, resulting a low low combustible gas (CO, CH<sub>4</sub>).

Figure 2 shows the ballast (sum of humidity and ash) variation and fixed carbon according to the results of the six tests).

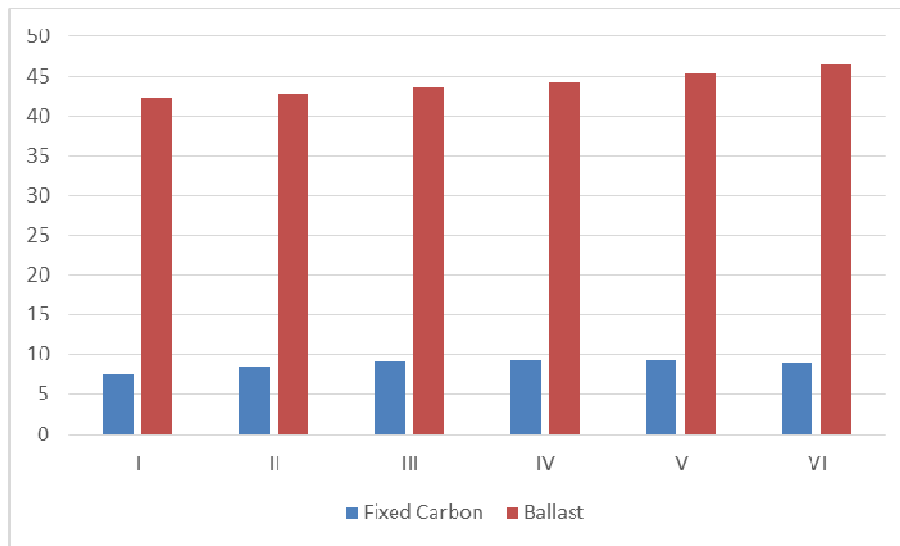

*Figure 2 Fixed carbon and ballast for each test*

The appearance of ash is whitish with particles without agglutination. These conclusions on ash demonstrate the possibility of evacuating it with classical installations at the outbreak of a combustion plant. The results of elemental analysis for the six samples are presented in Table 2.

Table 2 Energy characteristics of poultry manure

Test \ Characteristic [%]	I	II	III	IV	V	VI
C <sup>i</sup>	16.2	14.4	12.1	12.3	13.3	11.2
H <sup>i</sup>	4.7	4.5	4.9	4.2	4.3	4.4
S <sub>c</sub> <sup>i</sup>	1.7	1.6	1.7	1.7	1.6	1.8
O <sup>i</sup>	33.5	35.1	36.1	35.7	33.9	34.4
N <sup>i</sup>	1.6	1.7	1.7	1.8	1.6	1.7
A <sup>i</sup>	6.2	7.1	6.3	6.2	6.2	6.2
W <sub>t</sub> <sup>i</sup>	36.1	35.6	37.2	38.1	39.1	40.3

The lower calorific power variation for the six samples is presented in Table 3. The calorific value was calculated by means of formula:

$$H_i^i = 339C^i + 1029H^i - 109(O^i - S_c^i) - 25.1W_t^i \quad [kJ/kg] \quad (1)$$

Table 3 Lower calorific value (LCV) of the poultry manure

LCV - H <sub>i</sub> <sup>i</sup>	Test					
[kJ/kg]	I	II	III	IV	V	VI
	5955.9	5172.9	4460.7	3829.2	4434.3	3795.5

The results of analyzes proved the following characteristics:

- high total humidity (W<sub>t</sub><sup>i</sup>);
- high sulfur sulphur (S<sub>c</sub><sup>i</sup>) content;
- high oxygen content (O<sup>i</sup>);
- small LCV (H<sub>i</sub><sup>i</sup>).

This LCV pool confirms the hypothesis of a sustained hydrocarbon combustion as heat input and the use of an uncooled combustion chamber. This fuel has similarities with peat or brown coals.

In order to find the ignition temperature specific to a combustion on the grate in an uncooled furnace (surrounded with chamotte brick walls) was determined by introducing a quantity of 200 g into such small furnace, provided with an electric heater behind the chamotte. Figure 3 shows the appearance of ignition (the corresponding temperature was measured in the range of 875-950 °C).

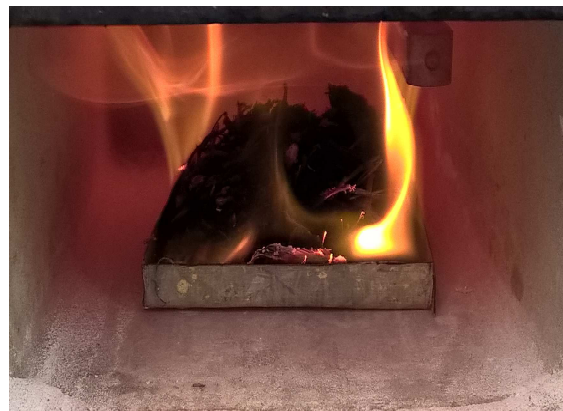

Figure 3 Moment of poultry manure ignition

### 3. CONCLUSIONS

In conclusion, the analysis of the energy characteristics of poultry waste demonstrates the possibility of its combustion as a production of energy in a certain amount compared to the total obtained and with a thermal support fuel.

The combustion plant is expected to be equipped with a mobile-inclined grate, located in a uncooled furnace provided with a chamotte inclined vault, in order to cause the ignition by its radiation.

### ACKNOWLEDGEMENTS

„This work was supported by a grant of the Romanian Ministry of Research and Innovation, CCCDI – UEFISCDI, project number PN-III-P1-1.2-PCCDI-2017-0404/31PCCDI/2018, and project number 37BMPNIII-P3-199/2016-I05.16.01, within PNCDI III”

### References

- [1] Felipe Santos Dalolio ş.a. „Poultry as biomass energy: A review and future perspectives”, *Renewable and Sustainable Energy Reviews* 76 (2017) 041-949
- [2] Edwards DR, Daniel TC, „Environmental impacts of farm poultry waste disposal – a review”, *Biores Technol* 1992; 41:9-33, [http://dx.doi.org/10.1016/0960-8524\(92\)90094-E](http://dx.doi.org/10.1016/0960-8524(92)90094-E)
- [3] Garces A, Afonso SMS, Chilundo A, Jairoce CTS, „Evaluation of different litter materials for broiler production in a hot and humid environment: 1. Litter characteristic and quality. *J Appl poult Res* 2013;22:168-76. <http://dx.doi.org/10.3382/japr.2012-00547>
- [4] Haapapuro ER, Barnard ND, Simon M. „Review: animal waste use as livestock feed: Dangerous to human health. *Prev Med* 1997;26:599-602. <http://dx.doi.org/10.1006/pmed.1997.0220>.

# EVALUATION OF EROSION RISK FOR A COGENERATION STEAM TURBINE WHEN STEAM PARAMETERS CHANGE

Gabriel Negreanu<sup>1</sup>, Ion Oprea<sup>1</sup>, Radu Băcanu<sup>2</sup>, Dragos Baciuc<sup>2</sup>

<sup>1</sup>University Politehnica of Bucharest

<sup>2</sup>Elsaco Electronic Botoșani

## ABSTRACT

The paper analyses the possibility of erosion risk increase for the last blade of a back-pressure steam turbine when steam conditions before and after turbine are changing due to various operational regimes. A complete verification “stage by stage” calculus has been performed, in order to reveal the geometrical dimensions (average diameters, lengths of nozzles and blades, characteristic angles) and operational ones (adiabatic and internal enthalpy drops, absolute and relative steam velocities, internal efficiencies and powers). After that, a behavioral model for unrated charges was setup and boundaries conditions (such as pressure and temperature of live steam or back-pressure) were modified, according to real operational regimes. Some collected parameters (moisture, pressure, tip velocity) were collected as inputs for several erosion criteria.

## 1. INTRODUCTION

Steam expansion in the turbine is a fast-moving thermodynamic process. The condensation process does not start on the saturation curve ( $x=1$ ), as in a quasi-static process, but is delayed and starts on constant humidity curves known as Wilson curve. The delay of the condensation phenomenon are characterized by the speed of expansion:

$$\dot{p} = -\frac{1}{p} \frac{dp}{d\tau} = -\frac{c_a}{p} \frac{dp}{dx} \quad (1)$$

The Wilson curves corresponding to the different expansion rates (Figure 1) show that the delay is even higher as the expansion speed increases.

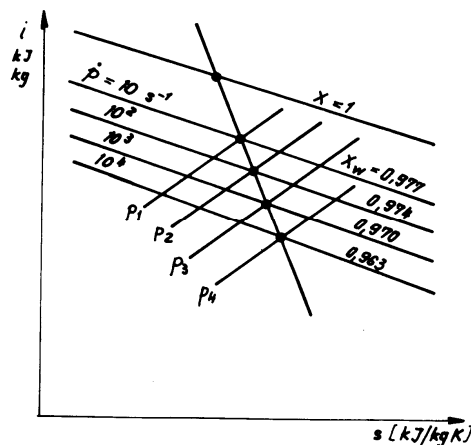

Figure 1. Wilson curves for initiation of condensation in the turbine

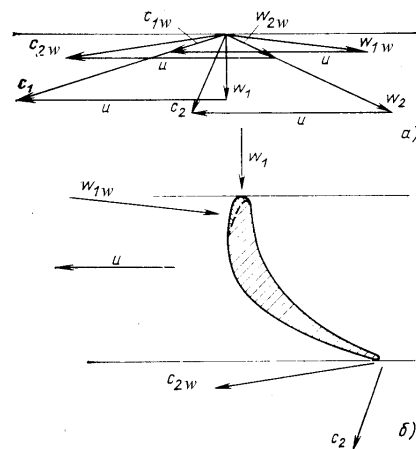

Figure 2. Velocity diagrams for wet steam (index w – water droplets)

<sup>1</sup>email: gabriel.negreanu@upb.ro

At a certain moment in the turbine stage the humidity is in two forms:

- droplets driven by the vapor stream; the trajectory of these drops depends on the mode of formation, size and drive speed;
- film on the surface of the nozzles and blades, formed by dropping, drifting in motion at a low speed. The film breaks at the nozzle exit edge in the form of droplets of relatively large diameter, in the order of magnitude of the thickness of the edge.

The fine droplets are trained at speeds and trajectories close to vapor, the large droplets in the macrodispersion fraction have very different velocities and trajectories, their impact with the pallet entrance edge causing its erosion (Figure 2).

Assessing the risk of erosion is difficult to do by using theoretical elements. Basically, relatively simple criteria are used that take into account the amount of moisture, impact energy and steam parameters.

The condensing turbines, in order to increase performance, work with low condenser pressures, the lower limit being imposed by the coolant temperature or the risk of erosion. The usual range of these pressures is  $p_c = (0,07 \div 0,03)$  bar. The risk of erosion generally occurs at the last step stage blades characterized by high humidity ( $y_0 > 0,05$  respectively  $x_0 < 0,95$ ) and low  $p_0$  pressure  $< 0,3$  bar and the long blade length leads to high peripheral speeds in the range  $u = (400 \div 550)$  m/s.

Under these conditions, the risk of erosion has to be assessed and measures taken to avoid it, by protecting the edge of the blades, changing the parameters of the steam, intensifying the internal collection of moisture. Changes in live steam parameters, such as temperature drop (Figure 3) or increase in pressure (Figure 4), which increase the humidity at the turbine outlet, must be accompanied by an erosion hazard assessment using criteria set by various turbine manufacturers (Table 1).

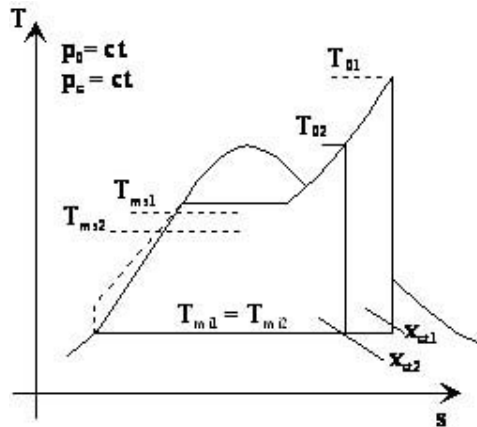

Figure 3. Live steam temperature drop on the final vapor content of the steam

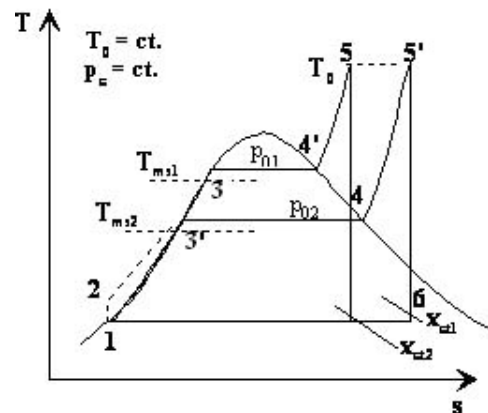

Figure 4. Live steam pressure increase on the final vapor content of the steam

The influence of the exhaust condensing pressure drop is very important too. Coolant temperature is a natural limit to lowering condenser pressure in order to increase enthalpy yield and fall. Another limit is given by the increase of steam humidity at the turbine discharge, (decrease of the vapor fraction).

Operating with a higher exhaust pressure than the condensing rated value is so called “worsened vacuum” regime and contributes to the decrease of the moisture (a positive effect for the erosion), but produces also an efficiency drop for the last stage, due to the “breaking effect”.

Table 1 Erosion criteria for the last stage blades of the steam turbines

Criterion	Reference	Equation	Erosion risk assesment
<b>Escher Wyss (1)</b>	[1]	$E = \frac{y_0 \rho}{\eta} \frac{c_{2a}}{200} \left( \frac{u}{400} \right)^2$	$E < 1$ no erosion risk $E \geq 1$ erosion risk; blades should be protected
<b>Escher-Wyss (2)</b>	[2,3]	$E = \frac{y_0 \rho}{\eta} \frac{c_{2a}}{200} \left( \frac{u}{100} \right)^4$	
<b>KWU</b>	[1]	$E = \frac{y_0^2}{p_0} \left( d \frac{n}{3000} \right)^2$	$E < 0.2$ no erosion risk $0,2 < E < 0.8$ erosion risk; $E > 0.5$ blades should be protected
<b>Hitachi</b>	[2,3]	$E = 4,3 \cdot (0,01 \cdot u - 2,44)^2 \cdot y_1^{0,8}$	$E < 2$ no erosion risk $2 < E < 4$ erosion risk $E > 4$ very high erosion risk

where:  $y_0$  [-] – humidity at stage inlet;  
 $y_1$  [-] – humidity between nozzles and blades;  
 $\rho$  [kg/m<sup>3</sup>] – steam density, at the stage outlet;  
 $\eta$  – coefficient of quality for the moisture reduction system: ( $\eta = 1$  for modern systems;  $0,8 < \eta < 1$  for old systems);  
 $p_0$  [bar] – pressure at stage inlet;  
 $c_{1a}$  [m/s] – axial velocity at nozzles outlet;  
 $c_{2a}$  [m/s] – axial velocity at blades outlet;  
 $u$  [m/s] – peripheral velocity at blade's tip.

## 2. METHODOLOGY

### 2.1. Turbine operating parameters

The analyzed steam turbine holds an impulse control stage and 16 reaction stages. The main operating parameters are:

- Live steam nominal parameters:  $p_{0n}=49,0$  bar,  $t_{0n}=447$  °C;
- Minimal live steam pressure:  $p_{0min}=44,0$  bar; Minimal live steam temperature:  $t_{0min}=390$  °C;
- Nominal steam mass flow rate:  $\dot{m}_0^n=20,7$  t/h; Maximal steam mass flow rate:  $\dot{m}_0^{max}=21,5$  t/h; Minimal steam mass flow rate:  $\dot{m}_0^{min}=8$  t/h;
- Nominal parameters of the steam extraction for the deaerator:  $p_D=5,75$  bar;  $t_D=217$  °C;  $\dot{m}_D=0,408$  t/h;
- Condensing pressure:  $p_{Cn}=0,89$  bar;  $p_{Cmin}=0,52$  bar.
- Rotation speed:  $n= 9944$  rot/min;

## 2.2. Nominal regime design/verification calculus

By not having a precise step-by-step calculation of the nominal steam turbine regime (on which modeling of non-nominal regimes is based), we proceeded to a design/verification calculation using the geometric dimensions and the nominal parameters presented in paragraph 2.1.

The impulse control stage has an isentropic drop of 140 kJ/kg, an average diameter  $d_1=0,47$  m, an admission grade  $\varepsilon=0,32$  and an internal efficiency  $\eta_i=0,715$ . The internal power produced by the control stage is 578 kW, representing about 15 % of overall turbine internal power.

Starting from the exit point in the control room chamber, the real process in the pressure stages can be drawn, based on the deaerator parameters ( $p_D = 5.75$  bar;  $t_D = 217$  ° C) and the pressure at the condenser ( $p_{Cn} = 0.89$  bar). By the energy balance (imposing the rated electrical power at the 3.6 MW<sub>e</sub> generator output) the real expansion process in the  $h$ - $s$  Mollier diagram. The parameters of this process are presented in Table 2.

Table 2 Parameters of the real expansion process in the pressure stage

High Pressure Section			Low Pressure Section		
$p_{0TPCIP} =$	29.40322	bar	$p_{0TPCJP} =$	5.75	bar
$h_{0TPCIP} =$	3210.805	kJ/kg	$h_{0TPCJP} =$	2888.703	kJ/kg
$s_{0TPCIP} =$	6.901083	kJ/kgK	$s_{0TPCJP} =$	7.066408	kJ/kgK
$p_{2TPCIP} =$	5.75	bar	$p_{2TPCJP} =$	0.89	bar
$t_{2TPCIP} =$	217	°C	$h_{2iTPCJP} =$	2547.295	kJ/kg
$h_{2iTPCIP} =$	2810.668	kJ/kg	$H_{iTPCJP} =$	341.4084	kJ/kg
$H_{iTPCIP} =$	400.1363	kJ/kg	$\eta_{iTPCJP} =$	0.745221	
$h_{2TPCIP} =$	2888.703	kJ/kg	$H_{iTPCIP} =$	254.4246	kJ/kg
$H_{iTPCIP} =$	322.1012	kJ/kg	$h_{2TPCJP} =$	2634.279	kJ/kg
$\eta_{iTPCIP} =$	0.804979	-	$v_{2TPCJP} =$	1.859481	m <sup>3</sup> /kg
$m_{TPCIP} =$	5.749444	kg/s	$x_{2TPCJP} =$	0.984313	-
			$s_{2TPCJP} =$	7.301797	kJ/kgK
			$m_{TPCJP} =$	5.636111	kg/s

## 2.3. Non nominal regimes modeling

For these regimes we used the hybrid method described in [7]. The method is based on the relationship between pressure distribution and mass-flow rate at partial loads (Stodola):

$$\frac{m}{m_n} = \sqrt{\frac{p_1^2 - p_2^2}{p_{1n}^2 - p_{2n}^2} \cdot \frac{T_{1n}}{T_1}} \quad (2)$$

and the dependence internal efficiency versus load, represented by the relative fictive

$$\text{velocities ratio } \bar{r}_v = \frac{\frac{u}{c_{fic}}}{\left(\frac{u}{c_{fic}}\right)_n} \quad (3)$$

$$\text{for control stage: } \eta_{iR\text{ATEAU}} = k_0 \cdot k_{(u/c)} \cdot \left( 0,83 - \frac{2 \cdot 10^{-4}}{\dot{m}_0} \cdot \sqrt{\frac{p_0'}{v_0'}} \right) \quad (4)$$

$$\text{and pressure stages: } \bar{\eta}_i^{si} = \bar{r}_v \cdot (2 - \bar{r}_v) \quad (5)$$

### 3. RESULTS AND CONCLUSIONS

We ran several tests, presented in table 3.

*Table 3 Parameters of analyzed operating modes*

Nr.crt	$\dot{m}_0$ [kg/s]	$p_0$ [bar]	$t_0$ [°C]	$p_c$ [bar]
OM1	5.75	49	447	0.89
OM2	2.22	49	390	0.43
OM3	2.22	29	350	0.43
OM4	2.22	47	445	0.89

- Operating mode 1 is the nominal mode, as a nominal flow of the district heating water flows through the condenser; it is noted that the exit point in the turbine is above the Wilson curve, which means that the water droplets have not yet formed and only the last stage works partially under the saturation curve.
- Operating mode 2 is the mode in which the live steam flow is kept at the technical minimum and its pressure is brought to its nominal value, while the temperature drops with 57 degrees Celsius; it is the most unfavorable in terms of humidity, five stages working with humid saturated steam. It has also the lowest evacuation vapor content (0.948)
- Operating mode 3 is a start-up one, limited as duration; It is noted also that 5 stages operate under the saturation curve
- Operating mode 4 is a partial mode with minimal steam flow at which nominal pressure is maintained at the condenser by regulating the flow rate of district heating water. It is noteworthy the operation of the last stage in brake mode with power consumption and negative internal efficiency.

*Table 4 Erosion criteria*

Nr.crt	$x_c$	EW(1) <1	EW(2) <1	KWU <0.2	Hitachi <2
	[-]				
OM1	0.986	0	0	0	0.0110
OM2	0.948	0.022	0.2629	0.0089	0.0311
OM3	0.949	0.0022	0.2568	0.0085	0.0306
OM4	0.958	0.0024	0.2829	0.0063	0.0261

**No risk for erosion, all the criteria from Table 1 returned values less than limits. The red curve of constant vapor content  $x=0.88$  has never been touched by the expansion lines.**

The expansion lines are presented in figure 5. The green curve represent the saturation line ( $x=1$ ), the brown one the Wilson curve.



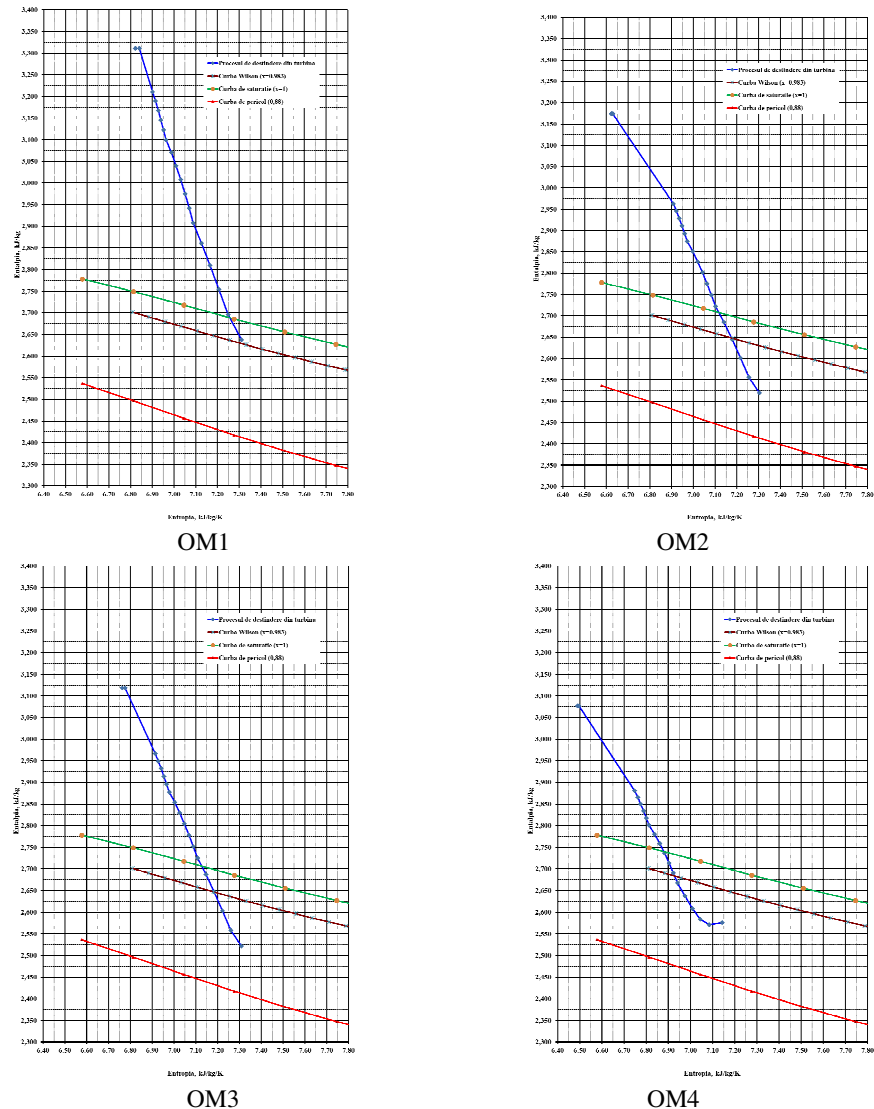

Figure 5: Expansion lines in Mollier diagram for the four cases

## ACKNOWLEDGMENTS

„This work was supported by the project UPB: T-ME 16-17-01, financed by Elsaco Electronic and by the grant of the Romanian Ministry of Research and Innovation, CCCDI – UEFISCDI, project number PN-III-P1-1.2-PCCDI-2017-0404 / 31PCCDI/2018”

## References

- [1] Grecu T., Cardu M., Nicolau, I., “*Turbine cu abur*”, Editura Tehnică, 1976
- [2] Leyzerovich A. Sh., “*Wet Steam Turbines for Nuclear Power Plants*”, Penwell Corporation, Ed. I, 2005.
- [3] Leyzerovich A. Sh., “*Steam Turbines for Modern Fossil-Fuel Power Plants*”, The Fairmont Press-Inc., 2007.
- [4] Negreanu G., Oprea I., Le calcul de verification pour le regim de project d'un etage de turbine qui utilise de le vapeur humide, International Simposium on Nuclear Energy, București 1993.
- [5] Oprea I., Contribuții privind curgerea aburului umed în treptele turbinelor, Sesiune de comunicări științifice, ICSITEE, București 1989.
- [6] Oprea I., Negreanu G., Aspects of the Saturated Steam Turbine Calculation for Partial Loading, International Simposium on Nuclear Energy, București 1993.
- [7] Negreanu G., „*Teoria și modelarea turbomașinilor*”, Editura Printech 2007, ISBN 978-973-718-624-9.

# **THE USE OF RAW ANIMAL FATS-BUTHANOL-DIESEL FUEL BLENDS AT DIESEL ENGINE**

Cernat Alexandru<sup>1</sup>, Pana Constantin, Lazaroiu Gheorghe,  
Negurescu Nicolae, Nutu Cristian, Nicolici Adrian  
University Politehnica of Bucharest

## **ABSTRACT**

The use of the alternative fuels, even in partial substitution, may represent a viable solution to reduce the diesel engine pollutant emissions and to maintain the diesel engines in service and in urban traffic. The animal fats-buthanol-diesel fuel blends are an alternative fuel which can be used at diesel engines, in order to reduce the pollutant emissions. The main advantages of animal fats- diesel fuel blends like cetane number and calorific value very close to diesel, higher oxygen content it recommend it as a good alternative fuel for diesel engines, being renewable and energy efficient. The results of experimental investigations show the animal fats and buthanol effects on the combustion parameters and on the pollutant emissions. Animal fats-buthanol-diesel fuel blends can be considered a viable alternative fuel for diesel engine, assuring the partial replace of the fossil fuels and resolving the major problem of animal wastes

## **1. INTRODUCTION**

After the 2015 Paris Climate Conference and the C40 Events-C40 Mayors Summit 2016 diesel engine pollution issue becomes a priority for some capital cities (Paris, Madrid, Athens and Mexico City) which will not legally allow anymore the access of automotives with diesel engines starting with year of 2020.

The use of alternative fuel obtained from renewable sources to diesel engines fuelling is a viable solution for replace of the fossil fuels and for pollutants emissions and greenhouse gases effect decrease. The animal fats have a high potential, due to their good combustion properties and due to great reserves can be used with success at diesel engines. They are oxygenated fuels, non toxic, sulphur free and contain more oxygen compare to diesel fuel [1].. The main disadvantages of animal fats are their high viscosity and poor volatility. Because of their high viscosity, the preheating of animal fats results in a significant decrease of viscosity, which allows the diesel engine fuelling without constructive modifications [2]. By use of buthanol in mixture with diesel fuel and animal fats the new fuel viscosity significant decreases and the fuel atomization is improvement [3].

Animal fats are lipid materials, being composed of triglycerides. Animal fats are in more parts constituted from tryglicerides and saturated monocarboxylic fat acids with number of carbon atoms (C12-C18) in which palmitic and stearic acids are predominant [2]. Animal fats have a lower content of carbon and hydrogen and higher oxygen content comparative to diesel fuel. The viscosity of the animal fats is of 15 times greater than diesel fuel at 40°C, table 1, [2]. At the raw animal fats use, the engine power is lower compared to diesel fuelling (the lower heating value of animal fats is with almost 10% lower as the diesel fuel- table 1). By increasing the cyclic fuel dose for the same air/fuel ratio, the engine power can be corrected because of the higher oxygen content of animal fats than diesel fuel [2].

In the table 1 a presented some of the physic-chemical properties of diesel fuel and animal fats:

Table 1: The physic-chemical properties of diesel fuel and animal fats

Specific properties of the fuels	Diesel Fuel	Animal Fat
Density [g/ml]	0.8495	0.92
Viscosity at 40 °C [mm <sup>2</sup> /s]	2.96	45
Thick point [°C]	-12	6
Congealing point [°C]	-16	
Ignition point [°C]	74	170
Boiling point [°C]	191	344
Sulphur [% m]	0.036	0
Cetane number CN [-]	49.2	56
Caloric power Hi [MJ/kg]	42.9	39.77
Carbon [% m]	86.67	77.6
Hydrogen [% m]	12.96	12.3
Oxygen [% m]	0.33	12.5
Oxygen for combustion O <sub>t</sub> [kmol/kg cb]	0.1045	0.0915

Experimental investigations of a diesel engine with a single cylinder, air cooled, with direct injection, fuelled with fuel diesel and animal fat preheated to 70°C in mixture with ethanol showed follow results comparative to diesel fuel engine: increase of the autoignition delay; decrease of the exhaust gas temperature; decrease of NO<sub>x</sub> and smoke emissions level [4]. Same results were presented in others papers [5, 6, 7, 8].

In this paper are presented some results of preheated raw animal fats in mixture with diesel fuel and buthanol.

## 2. METHODOLOGY

The experimental investigations were carried on a CFR-IT9-3M experimental diesel engine. The engine was firstly fuelled with diesel fuel and then with blends of diesel fuel-animal fats –buthanol for the same engine adjustments (13 °CA injection timing and  $\epsilon=13.74$  compression ratio). The fuel cyclic dose (28.9 mm<sup>3</sup>/cycle) was maintained constant at for all experimental tests. The diesel engine was equipped with AVL pressure transducer line, Kubler speed incremental transducer, real time AVL data acquisition system, AVL gas analyzer and smoke meter, thermo resistances for engine cooling liquid temperature, engine oil and air intake temperatures, and thermocouples for exhaust gas temperature. The high viscosity and poor vaporization characteristics of animal fats need prior their heating and their content limit in mixture with diesel fuel.

Was used the following methodology:

The animal fats are perfect soluble in diesel fuel at ~40 °C. At this temperature were prepared diesel fuel-animal fats (5% and 10% vol.)- buthanol (5% vol.) blends.

In figure 1-3 are presented the some effects of the animal fat and buthanol in mixture with diesel fuel.

In figure 1 the NO<sub>x</sub> emissions level variation with the animal fats content in mixture with diesel fuel and buthanol ( $x_m$ ) is presented.

The NO<sub>x</sub> formation is favored of the high temperature zone associated to the preformed mixtures combustion. Decreasing of NO<sub>x</sub> emission with 65% at the increasing of fats content, figure 1, is explained by reduction of the preformed mixtures quantity because of the

atomization aggravation, which leads to combustion temperature decrease comparative to diesel engine fuelled with diesel fuel, figure 2.

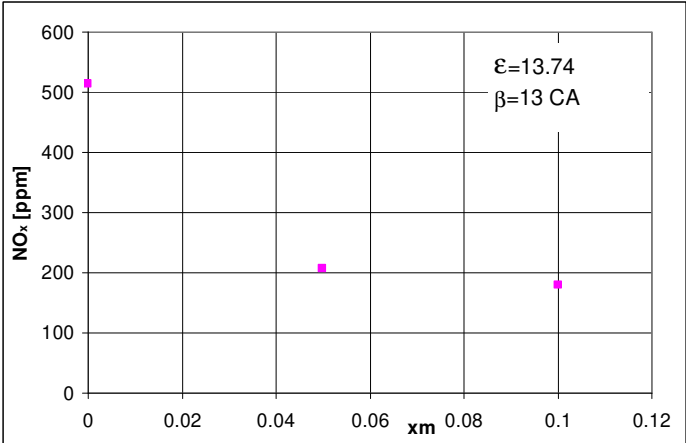

Figure 1: NO<sub>x</sub> emissions level versus animal fats content

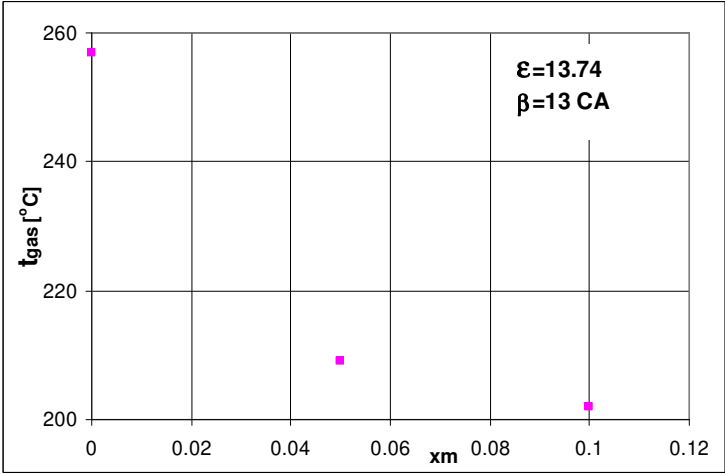

Figure 2: The gas temperature versus animal fats content

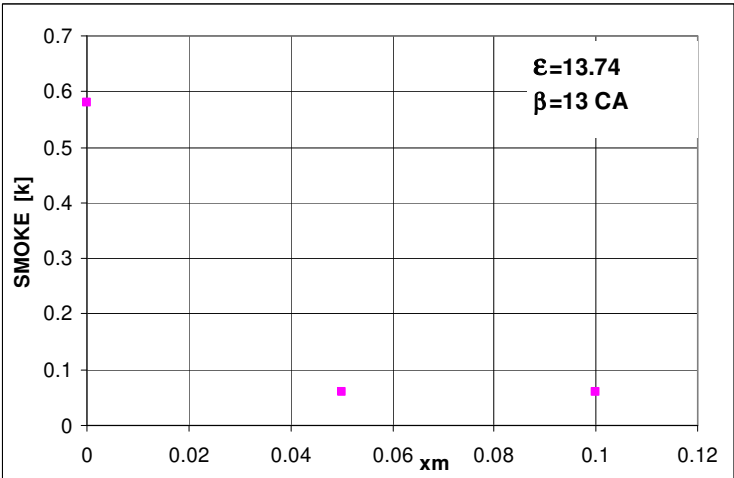

Figure 3: Smoke emissions level versus animal fats content

In figure 3 smoke emission level variation versus the percent of animal fats in mixture with diesel fuel for same butanol content is presented. Reduction of smoke emission level may be explained by carbon content reduction and oxygen content increase at molecular level (the animal fats and butanol have higher oxygen content in their molecule). Comparative to diesel fuel fuelled engine, a reduction with 87% of smoke emission level for  $x_c=10\%$  was obtained.

### 3. CONCLUSIONS

The use of animal fats and butanol in mixture with diesel fuel at the diesel engine assures pollutant emissions decrease. The  $\text{NO}_x$  and smoke emissions level decreases. Animal fats can be considered a good alternative fuel for diesel engine, they achieving the partial replace of the fossil fuels and resolving the major problem of origin animal wastes from leather industry.

#### Acknowledgments

The authors address special thanks to AVL GmbH Graz Austria for providing the necessary equipments. The work has been funded:

- by a grant of the Romanian Ministry of Research and Innovation, CCCDI-UEFSCDI, project number PN-III-P1-1.2-PCCDI-2017-0404, within PNCDI III”
- by University Politehnica of Bucharest, through the “Excellence Research Grants” Program, UPB – GEX 2017. Identifier: UPB- GEX2017, Ctr. No. 62 /2017
- by the Sectoral Operational Programme Human Resources Development 2007-2013 of the Ministry of European Funds through the Financial Agreement POSDRU/159/1.5/S/134398

#### References

- [1] Venkatraman, M., Devaradjane, G., ”*Effect of Compression ratio, Injection Timing and Injection Pressure on a DI Diesel engine for better performance and emission fueled with diesel-diesel biodiesel blends*“, International Journal of Applied Engineering Research, Vol. 1 , No 3 , 2010.
- [2] Gheorghe Lazaroiu, Constantin Pană, Lucian Mihaescu, Alexandru Cernat, Niculae Negurescu, Raluca Mocanu, Gabriel Negreanu, *Solutions for energy recovery of animal waste from leather industry, Energy Conversion and Management*, 2017, pp: 1-11, ISSN: 0196-8904, Available online 28 June 2017, <https://doi.org/10.1016/j.enconman.2017.06.042>, indexat ISI, WOS, Thomson Reuters, IF: 5.63 (2016).
- [3] Oguzhan Dogan, *The influence of n-butanol/diesel fuel blends utilization on a small diesel engine performance and emissions*, *Fuel* 90 (2011) 2467–2472.
- [4] Kerihuel, A., Kumar, M., S., Bellettre, J., Tazerout, M., “*Investigations on a CI Engine Using Animal Fat and Its Emulsions with Water and Methanol as Fuel*”, SAE International, Paper Number 05P-95, 1995.
- [5] M. Senthil Kumar , A. Kerihuel ,J. Bellettre , M. Tazerout , “*A Comparative Study of Different Methods of Using Animal Fat as a Fuel in a Compression Ignition Engine* “ , Journal of Engineering from Gas Turbines and Power, Vol. 128, October 2006.
- [6] Cernat A, Pana C, Negurescu N, Lazaroiu Gh, Nutu ., *Aspects of the animal fat use at the diesel engine fuelling*, UPEC 2015 Proceedings of Staffordshire University 2015.
- [7] Srinivasa Rao K, Ramakrishna DrA, Rao PV, *Performance and emission characteristics of DI-CI diesel engine with preheated chicken fat biodiesel*, International journal of mechanical engineering and technology 2013; 4(3).
- [8] Kumar, A. Kerihuel, J. Bellettre, M. Tazerout, M. Senthyl, *The use of preheated animal fat as fuel in a compression ignition engines*, Renewable Energy 2005; 30(9):1443-1456. [http://sol3d.com/\\_backup/1.0/.../ak/preheating.pdf](http://sol3d.com/_backup/1.0/.../ak/preheating.pdf).

# A RESEARCH ON FUELLING A CAR DIESEL ENGINE WITH LIQUEFIED PETROLEUM GAS

Nikolaos Cristian Nutu<sup>1</sup>, Constantin Pana<sup>2</sup>, Nicolae Negurescu<sup>2</sup>,  
Alexandru Cernat<sup>2</sup>, Dinu Fuiorescu<sup>2</sup>, Liviu Nemoianu<sup>2</sup>

<sup>1</sup>Automotive Engineering Department, University Politehnica of Bucharest, Romania

<sup>2</sup>Thermotechnics, Thermal Engines and Equipments, Refrigeration Instalations,  
University Politehnica of Bucharest, Romania

## ABSTRACT

The paper presents experimental investigations results of a car diesel engine fuelled with diesel fuel and liquefied petroleum gas by diesel-gas method with the main purpose to reduce the level of the nitrogen oxides emissions and the smoke emission. The use of LPG represents an efficient way to reduce the classic fuels consumption, maintaining the energetic performances of the engine. The test bed situated in the Thermotechnics, Engines, Thermal Equipments and Refrigeration Instalations Department was adapted for liquefied petroleum gas fuelling of the diesel engine. The engine used for investigations is a turbocharged 1.5 l diesel engine which run at 3500 rpm and 70% engine load. By LPG fuelling of the investigated diesel engine a decrease has been achieved in the nitrogen oxides emissions level and in the smoke emission level. Also the break energetic specific consumption decreased compared to the standard diesel engine. The results of the experimental investigations confirm the viability of using LPG as an alternative fuel for the diesel engine.

## 1. INTRODUCTION

Liquefied petroleum gas, shortly LPG, is a fuel composed generally of propane and butane, in different ratios (usually 30% propane and 70% butane). The ratio of each component depends on season because in general in the cold season the propane ratio should be increased and also the ratio of the components is different between producing companies. Being a fuel with good combustion properties and a very good price liquefied petroleum gas is a viable alternative as a fuel for the compression ignition engines.

Some fundamental properties of LPG are presented in the table 1, compared with the diesel fuel properties.

Table 1. Liquefied petroleum gas properties [1].

Properties	Diesel fuel	Propane	Butane
Density [kg/m <sup>3</sup> ]	800-840	503	500
Self ignition temperature [°C]	355	481	544
Stoichiometric A/F ratio [kg/kg]	15	15.71	15.49
Lower heating value[MJ/kg]	42.5	46.34	45.55
Cetane number	40-55	-2	-2
Flame temperature	2054	1900	-

<sup>1</sup>phone: 0740634286; e-mail: cristi\_cmt@yahoo.com

Fuelling a diesel engine with LPG involves specific methods given that the LPG self ignition temperature is higher than diesel fuel and the cetane number is very low. In this paper the authors chose the Diesel-Gas method, where the gaseous LPG is injected in the intake manifold of the engine.

This method has been applied also by Tariq Miqdam in [2] with good results concerning the brake specific energetic consumption and pollutant emissions. In the paper [3] the authors chose for experimental investigations a car diesel engine, which was fuelled with LPG also using the diesel-gas method. As a result for the experiments a reduction in the operating price of the vehicle has been achieved. In the work [4] the authors decreased the level of the nitrogen oxides emission fuelling the diesel engine with LPG. On the other hand the level of unburned hydrocarbons increased but the authors managed to reduce this emission using a glow plug with the main purpose to reduce the flame extinguishing phenomenon [4]. Also Pali Rosha et al. in [5] by LPG fuelling a single cylinder diesel engine obtained a decrease in the level of pollutant emissions. The level of nitrogen oxides emissions and carbon dioxide emission decreased as against the standard diesel engine case, while emissions of unburned hydrocarbons and carbon monoxide increased. In order to reduce these emissions the authors used a percentage of recycled exhaust gas. Another example of a liquefied petroleum gas diesel engine fuelling is presented in the paper [6]. The authors used liquefied petroleum gas injection into the intake manifold of the engine and rapeseed oil which served as a pilot fuel injection. The maximum substitute ratio of rapeseed oil with LPG was limited by cyclic variability of the combustion process. The level of unburned hydrocarbons and carbon monoxide emissions decreased but the level of nitrogen oxides emissions increased. To reduce the emission of nitrogen oxides authors used also the exhaust gas recirculation.

This paper presents results of experimental investigations carried out on a car compression ignition engine fueled with liquefied petroleum gas using the diesel-gas method.

The engine is located in one of the test beds of the Department of Thermotechnics, Engines, Thermal Equipments and Refrigeration installations.

## 2. EXPERIMENTAL STUDY

The experimental study was carried out on a car compression ignition engine type K9K, with 4 cylinders in line. The specifications and performances of the engine are presented in the table 2.

The test bed consist of: K9K 792 1.5 dCi diesel engine, equipped with a LPG fuelling system. Laboratory equipments (figure 1) are: 1 – 1.5 dci diesel engine; 2 – engine cooling system; 3 – engine water cooler; 4 – intercooler fan; 5 – engine angular encoder; 6 –AVL piezoelectric pressure transducer; 7 – diesel fuel injector; 8 – LPG injector; 9 – Turbocharger; 10 – intake air drum; 11 – intake air flow meter; 12 – exhaust gas recirculation; 13 –Schenck E90 dyno; 14 – dyno-engine coupling; 15 –Schenck E 90 dyno cooling water pump; 16 –dyno cooling system; 17 –AVL Dicom 4000 gas analyzer; 18 –AVL Dicom 4000 Opacimeter; 19 – AVL charge amplifier; 20 – PC + AVL data acquisition system; 21 –Schenck E 90 dyno controller; 22 – temperatures displays: a) – exhaust gas; b) – intake air; c) – engine oil; d) – engine cooling liquid; e) – engine oil pressure; 23 – diesel fuel and LPG injection control Laptop; 24 – diesel fuel tank; 25 – diesel fuel mass flow meter; 26 – fuel filters; 27 – high pressure pump for common Rail; 28 –Common Rail; 29 – LPG tank; 30 – LPG mass flow meter; 31 – LPG vaporizer; 32 –LPG ECU; 33 –diesel engine ECU; 34 –intercooler; 35- supercharge pressure measuring system; 36- throttle actuator. The test bed diagram is presented in the figure 1.

**Table 2.** Specifications and performances of the K9K engine.

Number of cylinders	4
Bore	76 mm
Stroke	81 mm
Displacement	1.5 l
Compression ratio	18.3
Rated power	55 kW/3900 rpm
Maximum torque	156 Nm/2000 rpm
Admission type	turbocharged

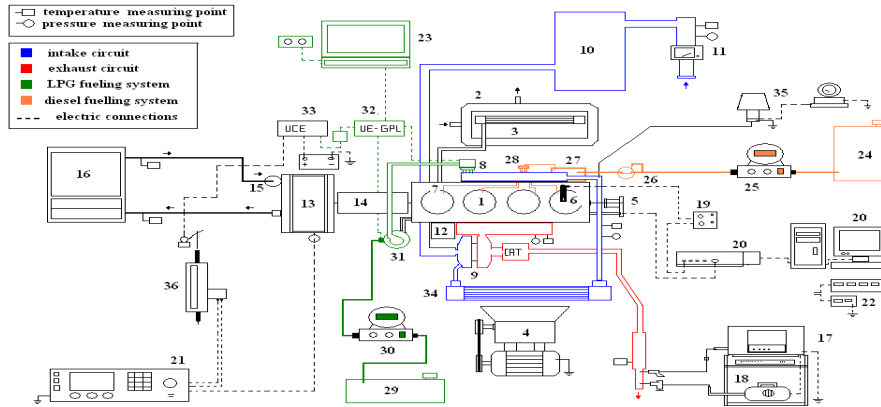

**Figure 1.** The test bed diagram.

First time was determined the reference, fuelling the engine only with diesel fuel, than the diesel fuel was partially substituted with liquefied petroleum gas with the purpose to maintain the same engine power like in the standard case of fuelling with diesel fuel and to reduce the pollutant emissions. For each substitute ratio investigated, the diesel fuel cycle quantity was reduced and the LPG cycle quantity was increased. The energetic substitute ratio mathematical relation is:

$$x_c = \frac{m_{LPG} H_{i_{LPG}}}{m_{LPG} H_{i_{LPG}} + m_{dieselfuel} H_{i_{dieselfuel}}} \quad (1)$$

Where:  $m_{LPG}$ - the LPG dose;

$m_{dieselfuel}$ -the diesel fuel dose;

$H_i$ - the lower heating value.

The investigated energetic substitute ratios of the diesel fuel with LPG was situated between [0-40.63] % and the working regimen was 70% engine load and 3500 rpm.

### 3. RESULTS AND DISCUSSIONS

The pressure inside the cylinder increased for all the investigate substitute ratios of diesel with LPG because of the intensification of the burning process due to the presence of LPG-air



mixture in the combustion chamber and because LPG has a higher flame speed. The in-cylinder maximum pressure variation is presented in the figure 1.

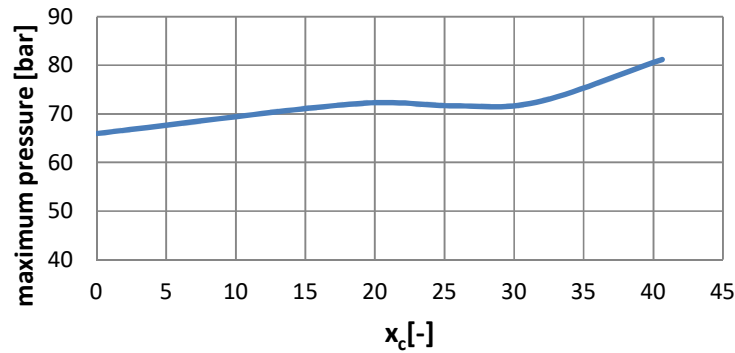

Fig. 1. The maximum in-cylinder pressure.

The maximum rate of pressure rise also increased for all the cases because the flame has a high speed in the homogeneous air-LPG mixture. The figure 2 presents the maximum rate of pressure rise for the investigated cases.

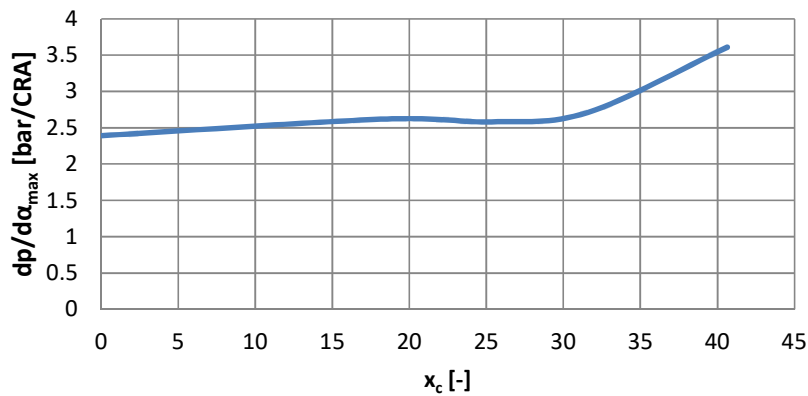

Fig. 2. The maximum rate of pressure rise.

The nitrogen oxides emission level decreased for all the investigated substitute ratios of diesel fuel with LPG because liquefied petroleum gas has a lower flame temperature than diesel fuel and because the combustion takes place in a shorter time, thus the nitrogen oxides formation decreases. The nitrogen oxides emission is presented in the figure 3.

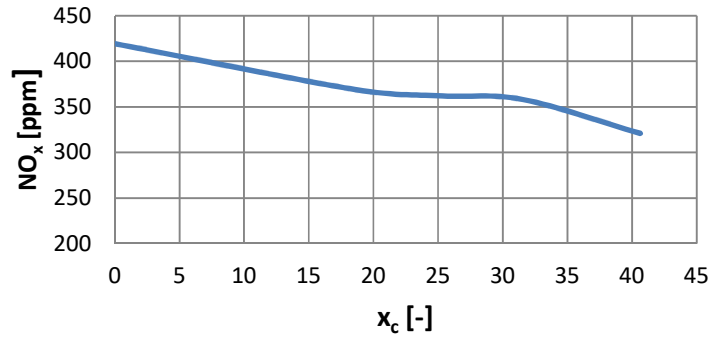

Fig. 3. The nitrogen oxides emission.

For substitute ratios up to 26% the smoke emission level decreased for all the investigated substitute ratios of diesel fuel with LPG because in the case of LPG fuelling the burning rate of diffusive mixtures decreases and the burning rate of preformed mixtures increases. For substitute ratios higher than 26% the smoke emission level increased due to the lack of air, LPG being injected in the intake manifold and replace a part of air, in order to reduce the smoke emission for higher substitute ratios the supercharging pressure must be increased. The figure 4 presents the measured smoke emission level, evaluated by the opacity.

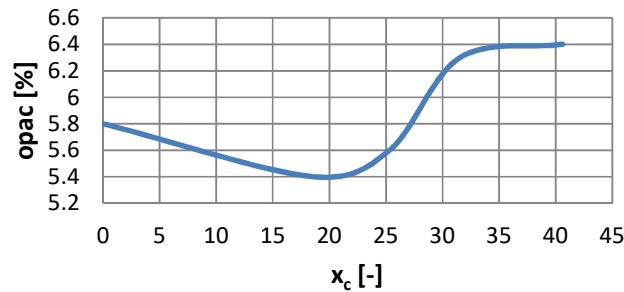

Fig. 4. The smoke emission level.

The brake specific energetic consumption decreased in the case of LPG fuelling. Figure 5 presents the brake specific energetic consumption variation.

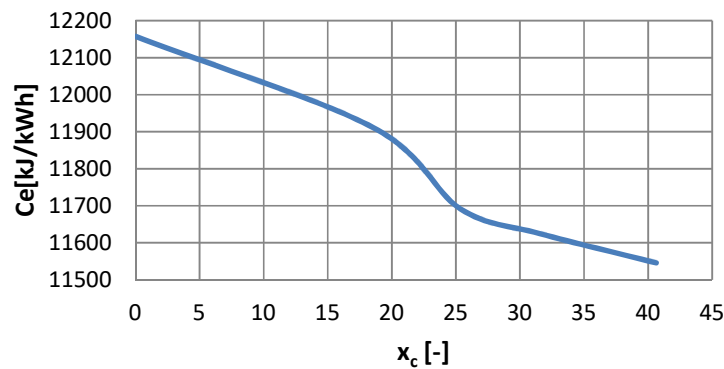

Fig. 5. The energetic specific fuel consumption.

## 4. CONCLUSIONS

At the LPG engine fuelling were observed the following:

1. The brake specific energetic consumption decreased with ~5% when the substitute ratio was  $x_c=40.63$ .
2. The nitrogen oxides emission decreased with ~23% for the substitute ratio  $x_c=40$ .
3. The smoke emission level decreased for substitute ratios of diesel fuel with LPG lower than 26 increased for higher substitute ratios because of the worsening of intake process.
4. The maximum pressure and the maximum rate of pressure rise increased in the case of LPG fuelling.

## 5. ACKNOWLEDGEMENTS

The authors would like to thank to AVL List GmbH Graz, Austria, for providing the possibility to use the research equipments.

This work has been funded:

- by University Politehnica of Bucharest, through the “Excellence Research Grants” Program, UPB – GEX 2017. Identifier: UPB- GEX2017, Ctr. No. 62 /2017.
- by a grant of the Romanian Ministry of Research and Innovation, CCCDI-UEFSCDI, project number PN-III-P1-1.2-PCCDI-2017-0404, within PNCDI III/31PCCDI/2018”.

## 6. REFERENCES

- [1]. Popa, M. G., Negurescu, N., Pana, C., *Motoare Diesel*, Matrix ROM, Bucuresti 2003.
- [2]. Miqdam, T., *Exhaust analysis and performance of a single cylinder diesel engine run on dual fuels mode*, Journal of Engineering, Nr. 4, Vol. 17, 2011.
- [3]. Michal, J. et al, *Analysis of engine parameters at using diesel-lpg and diesel-cng mixture in compression-ignition engine*, Acta Universitatis Agriculturae Et Silviculturae Mendelianae Brunensis, vol. 62, nr. 1, 2014.
- [4]. Vijayabalan, P., Nagarajan, G., Performance, Emission and Combustion of LPG Diesel Dual Fuel Engine using Glow Plug, Jordan Journal of Mechanical and Industrial Engineering, Volume 3, Number 2, June. 2009 ISSN 1995-6665 Pages 105 – 110.
- [5]. Rosha, P., Bharj, R.S., Gill, K., *Performance and emission characteristics of Diesel+LPG dual fuel engine with exhaust gas recirculation*, International Journal of Science, Engineering and Technology Research (IJSETR), Volume 3, Issue 10, October 2014.
- [6]. Tira, H.S, Herreros, J.M., Tsolakis, A., Wyszynski, M.L., *Characteristics of LPG-diesel dual fuelled engine operated with rapeseed methyl ester and gas-to-liquid diesel fuels*, Energy, Volume 47 (2012) 620-629.

# LOW POWER COGENERATION INSTALLATION USING SOLID VINEYARD WASTE BIOMASS

Ion Oprea<sup>1</sup>

University POLITEHNICA of Bucharest

## ABSTRACT

Our country owns important vineyard cultivated surfaces. Along with other forms of biomass, vineyards have the necessary energy characteristics to be used as renewable fuel in electrical / thermal energy producing in small power plants. This paper aims to demonstrate the viability of a low power cogeneration power plant when using such a resource.

## 1. INTRODUCTION

The use of biomass for energy production is an important way to reduce the impact of energy systems on the environment and to implement the rules brought in this field by European Union. Although the biomass has a considerable share in renewable energy in our country, it has a reduced use for the production of electricity and heat, whether centralized or collective-decentralized. The installed production capacity was 130.4 MW on April 1, 2018, and prospects for the next three years are given in Table 1 [2].

Table 1. The evolution of net power available for biomass [MW]

2018	2019	2020
150	160	180

Biomass is commonly used in rural areas for heating and for food preparation. We generally talk about low efficiency and high emission installations. About 14% of the biomass energy is generated in modern facilities.

The paper considers the solid biomass from the vineyards that is the grapevines obtained from the autumn and spring cuttings. Vines can be used energetically after drying, either by chopping them or as pellets.

## 2. VINE ROOTS - RENEWABLE ENERGY FUEL

Vines are obtained from the maintenance process of the vineyards, from the autumn and spring cuttings. Together with grape stones, the vines represent the renewable energy source of wine cultures. The area planted with vines was approximately constant in recent years, being 177.150 ha in 2017 [4, 5] and providing a safe source of raw material. However, in our country we cannot speak of a tradition in energy recovery of vineyard byproducts. This is due to the wide spread of crops, the lack of harvesting and baling machines, and the lack of drying and storage infrastructure. In this context, the energy recovery of vineyards must also take into account solutions that allow combustion together with wood waste, agricultural biomass and biomass from energy crops (energy willow, poplar etc.) in the form of pellets, briquettes or chopped.

---

<sup>1</sup> Splaiul Independentei nr. 313, sector 6, Bucharest, ROMANIA, PC RO-060042, +4021 4029158, oprea@caz.mecen.pub.ro

In order to be handled, stored and processed, the vines are harvested and packed with a special machine (Fig. 1). The typical dimensions of a bale are: diameter = 40 cm / length = 60 cm and weight of 15 kg/bale being easy to handle. During storage, the vines are dried, and when the humidity drops below 20 percent, bales can be cut or milled to serve as fuel in heating systems, or can be made into pellets. Upon cutting the vines have an average relative humidity of 35% and the lower calorific value is  $Q_{iw} \approx 12400$  kJ/kg and, after drying, at 10% humidity  $Q_i \approx 16560$  kJ/kg [9, 16]. By storage and drying, the vineyards reach an average moisture content of 10%, optimal for storage, burning or gasification, with a lower average calorific value  $Q_i \approx 19000$  kJ/kg; the price is about 0.50 RON/kg.

One hectare of vineyard cultivation has an average of 4000-5000 vine stocks that produce (0.5-1) kg of biomass/vine stock with relative humidity in the range of 30% to 40%, so between (2000-5000) kg/ha.year [9, 14]. These values can vary widely depending on variety, soil and climatic conditions. Estimating minimum mass of cut vines of about 2000 kg/ha, it follows that the minimum annual energy potential of one hectare is  $E_{pcv} = 24.8$  GJ/ha.year.

At national level, taking into account an area of at least 100,000 hectares of vineyards in production, the energy potential in the biomass from vines is  $E_{pcv} \approx 2480$  TJ/year, which corresponds to an annual consumption of 43,000 tons of diesel and to reducing CO<sub>2</sub> emissions by 128,000 t<sub>CO2</sub>/year which are appealing results.

### 3. LOW POWER COGENERATION INSTALLATION

The energy recovery of grapevines or mixtures of grapevines and logs can be done by using chopped material or pellets in low-power cogeneration systems with a back-pressure turbine or in ORC installations using organic fluid cycles.

Back-pressure turbines best meet the requirements of low-power cogeneration plants through efficiency, gauge and simplicity of the thermal circuit. The major disadvantage of back-pressure turbines is the dependence of their operation on the heat consumer. In the absence of the heat consumer, the turbine must be switched off or provided with a reduced cooling bypass system. Low thermal loads also reduce the plant's efficiency.

ORC installations using organic fluid cycles typically consist of two main modules:

- a module that ensures the burning of solid biomass and generates heat;
- a module that produces electrical and thermal energy in which the working fluid is organic.

The interface between the two modules is a heat exchanger. Such an installation can be used for both residential and small-scale heating. Power generation is achieved with a turbine that can be axial or radial-centripetal.

The proposed cogeneration plant recovers the energy potential of vines as such or in blends with waste / wood waste. This plant is designed for local heat supply of residential or small-scale enterprises. At the same time, the plant produces electricity to be injected into the national grid. The plant is destined for the Vrancea region, an important wine region with an area planted with vineyards of about 17,000 ha [4].

The construction type of the installation has been chosen taking into account the following main elements:

- the required heat load - a low-power plant was chosen to locally recover the energy potential of the vine. The potential heat consumer may be a woodworking or an agricultural products processing enterprise to which hot water is supplied. If an outlet pressure reduction and cooling station is provided, it could also feed residential consumers. For industrial consumers, the outlet pressure is 6 bar. In the case of a residential complex for the summer period, the heat consumption will be significantly reduced, which will affect the performance of the plant, and the outlet pressure will be 1.2 bar. We chose the 6 bar outlet pressure, while

the electrical and thermal loads are to be determined by system calculation according to the available heat provided by the burning of the vines.

- combustion mode of biomass - In principle, two types of boilers can be selected: with grate burning or with burning in suspension. Installations and studies show that grate burning allows for higher thermal and electric loads of about 2 MWt and 250 kWe, while the burning in suspension required a 1.2 MWt and 140 kWe boilers. The way of preparing the biomass differs depending on the two solutions, namely on the grate it is burned in the form of pieces, pellets or briquettes, while in suspension it is burned as splinters or powder. Vines can be prepared for both combustion modes. For the solution calculated, we selected a boiler with a burning suspension of chopped vines alone or mixed with chopped wood. Boiler parameters for steam produced are in the ranges  $p_o = (20 \div 60)$  bar;  $t_o = (250 \div 450)$  °C. We opted for live steam parameters  $p_o = 30$  bar;  $t_o = 300$  °C

- type of energy machine - you can choose between a steam turbine or an organic fluid turbine if you opt for an installation that also integrates an ORC cycle.

Due to the fact that the plant is low power, according to the live steam parameters adopted, the steam flow will be reduced, although the specific volume is relatively high, which can cause problems with the intake section. Adopting a high speed may partially offset this shortcoming, but it is necessary to use a gear box to drive the electric generator. The steam turbine can be axial type with one or more stages, or axial radial type recommended for small enthalpy drops. In this situation we have chosen axial radial type a speed of 9000 rpm.

- a simpler heating circuit, which reduces the cost of the plant and is easy to operate. Choosing a back-pressure turbine simplifies the thermal circuit compared to a condensing turbine. We have opted for the lack of preheating of the supply water; in the heating circuit, only a pressure degasser is provided, 6 bar, which is supplied from the turbine exit or from the live steam by means of a pressure reduction; the supply water temperature will correspondingly be about 160 °C. For the safety of the heat supply to the heat consumer, there is also a cooling reduction device in the circuit that bypasses the turbine.

#### 4. PRELIMINARY CALCULATIONS

The following input data is considered:

- the amount of available biomass - given that, presently, the energetic recovery of the vine rows is happening randomly in very low power plants, we considered the harvesting of the vines on an area of about 15% of the potential of the Vrancea region, 2550 ha respectively. For a vine waste production of 3000 kg/ha.year, the annual quantity will be 7650 t/year. Under these conditions, the amount of heat available for an annual heat supply of 8400 hours / year and a calorific value of 12400 kJ/kg of vineyards is 93744 GJ/year

- the characteristic parameters of the thermal cycle are:

- estimated boiler efficiency  $\eta_{caz} = 0,80$
- live steam parameters  $p_o = 30$  bar,  $t_o = 300$  °C
- turbine outlet pressure  $p_e = 6$  bar
- water supply temperature  $t_{aa} = 160$  °C
- water supply pressure  $p_{aa} = 36$  bar

- the steam flow rate corresponding to these parameters is 1.083 kg/s.

The installed electric power is 0.179 MWe and the thermal power is 2.326 MWt.

The cogeneration plant is expected to operate 8400 hours per year, producing heat and electricity at nominal capacity. The winter operating time is 4400 hours/year, summer 4000 hours/year. Annually, 1504 MWh/year and 19538 MWt will be produced.

The value of the investment is estimated to be 3,750,000 RON and includes a solid biomass boiler, a back-pressure turbine (fully equipped), degasser, heat exchangers, pumps

(condensation, water supply, district heating), auxiliary (control, pipelines, fittings), bunker storage, civil buildings, facilities, personal training

The economic analysis period is 10 years. The purchase price of the vines waste is 500 RON/ton, the selling price of electric power is 150 RON/MWe, and the selling price of thermal energy is a variable that dictates the profitability of the project; a value of 250 RON/MWh was chosen; the return rate of investment  $r = 10\%$ .

## 5. RESULTS AND CONCLUSIONS

The solid waste of vineyard can be used in combined heat and power small power plants, responding to the strategy of distributed energy production, with economical and social benefits of local community.

The economic performances of the analyzed cogeneration plant show the viability of the solution. The net present value is 1,211,177 RON; the internal rate of return is 15.71 %, the investment is recovered in 6.5 years and the ratio benefit/cost is 1.33.

### Acknowledgments

*This work was supported by a grant of the Romanian Ministry of Research and Innovation, CCCDI – UEFISCDI, project number PN-III-P1-1.2-PCCDI-2017-0404 / 31PCCDI/2018, and project number 37BMPNIII-P3-199/2016-105.16. 01, within PNCDI III*

### References

- [1] Mihăescu L., Ceclan M., Oprea I., Prisecaru T., Pișă I., Ene A., Prisecaru M., Pop E., „Instalații termice neconvenționale”, Ed. Perfect, București 2002;
- [2] Transelectrica, date privind producția; <http://www.transelectrica.ro/web/tel/productie>;
- [3] Ministerul Agriculturii și dezvoltării rurale; [www.madr.ro/horticultura/viticultura-vinificatie.html](http://www.madr.ro/horticultura/viticultura-vinificatie.html);
- [4] Anuarul Statistic al României 2015;
- [5] Ambros T. "Surse Regenerabile de Energie" - Ed. Tehnică 1999;
- [6] Dragan V., Burchiu V., "Energile regenerabile și utilizarea acestora" Ed. Ceres 2012;
- [7] Victor Emil Lucian "Resurse energetice regenerabile. Ghid practic de proiectare, montaj, exploatare și întreținere a sistemelor de conversie care folosesc resurse regenerabile" – Ed. "Universitara"-2011;
- [8] Maican E., Murad E., Haraga G., Biriș S-Șt., „Utilizarea Potențialului Energetic al corzilor de viță”, Camera de Comerț și Industrie Râmnicu Vâlcea - iulie 2010.
- [9] <https://phys.org/news/2015-06-renewable-energy.html#jCp>;
- [10] Planul național de acțiune 2016-2020 privind schimbările climatice;
- [11] REN 21 RENEWABLE 2016 · GLOBAL STATUS REPORT;
- [12] IEA, World Energy Statistics and Balances, 2015 edition (Paris: 2015);
- [13] Begalli, D., Codurri, S., Gaeta, D.: Bio-energy from winery by-products: a new multifunctional tool for the Italian wine districts. Paper presented at the 113th EAEE Seminar: Belgrade, Republic of Serbia;
- [14] Cavalli R., Grigolato St., „Recolta e trasformazione dei sarmenti di vite in cippato: disponibilita potenziale e tecnica in provincia di Treviso” Università degli studi di Padova;
- [15] Franciscato V., Golfetto M., „Il cippato di vite nella caldaia annulla i costi per gasolio o gpl”, Biomasse, Analisi delle caratteristiche chimico-energetiche e delle emissioni, Supplemento a L'informare Agrario, nov. 2010. ;
- [16] Barella L., Paniz A., Antonini E., „L'uso energetico dei sarmenti della vite”, Valutazioni tecnico-economiche di filiere significative, Studio di fattibilità a cura di Veneto Agricoltura e Associazione Italiana Energie Agroforestali, 2010

# MODELLING OF DESULPHURIZATION PROCESS WITH THE SCOPE OF SO<sub>2</sub> EMISSIONS DECREASE AND INCREASE OF SYNTHETIC GYPSUM QUALITY

Tudor Prisecaru<sup>1</sup>, Malina Mihaela Prisecaru<sup>1</sup>, Razvan Lisnic<sup>2\*</sup>

<sup>1</sup>University POLITEHNICA of Bucharest, Faculty of Mechanical Engineering and Mechatronics, 313 Splaiul Independentei Street, Bucharest, Romania

<sup>2</sup>CEPROCIM S.A., 6 Preciziei Street, Bucharest, Romania

## ABSTRACT

An experimental model for wet flue gas desulfurization process with a limestone slurry is presented. The model was used to study the modelling of desulphurization process from which synthetic gypsum it is formed. Results further showed that the process must be controlled in order that gypsum is settling in good conditions.

**Keywords:** *fluid dynamics, mass transfer, wet FGD, SO<sub>2</sub> emissions, synthetic gypsum*

## 1. INTRODUCTION

Flue gases desulphurization [1-3] is a technique through which flue gases are treated for decreasing sulphur dioxide (SO<sub>2</sub>) concentration produced during combustion process of fossil fuels, with the scope of complying with the emission limit values (ELV). Flue gases desulphurization also allows obtaining high quality co-products that can be used as raw materials [4] in different fields. The objective of the study is the removal of SO<sub>2</sub> through chemical and physical procedures [5,6], as well as the integration of waste water management and co-products [7-9] into the economic value chain. A dynamic model has been developed to simulate system performance using the operating data provided by a coal-fired power plant.

## 2. METHODOLOGY

For performing laboratory tests an experimental installation was acquired for desulphurization of gases.

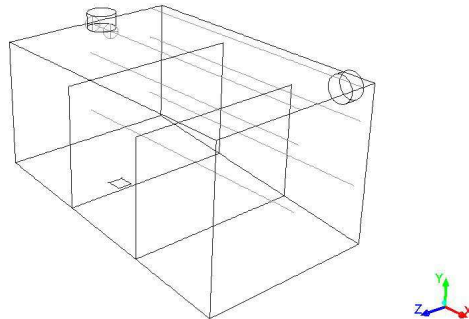

Figure 1. a) and b) Flue gas desulphurization experimental installation



For maximizing the efficiency of flue gases desulphurization and increasing of synthetic gypsum quality influencing the following parameters was considered: depressurization, interaction time (flowing rate of desulphurization solution) and oxidizing atmosphere (oxidizing conditions) for ensuring the transformation of sulphite ions into sulphate ions. Limestone dosing into the aqueous suspension was imposed at 20% and 30%. Further measurements of gypsum quality will restrict dosing range.

To assess the interfacial mass transfer CFD models prepared were post processed and reaction rates were represented alongside several axes within the tank, as it is shown in fig 2.



Mesh ANSYS Fluent Release 16.0 (3d, pbns, spe, rke) Dec 04, 2017

Figure 2. Axes for which reaction rates were processed

These axes are located at three points at 100mm, 300mm and 400mm heights. From their location point of view three of them are on the symmetry plan of the tank and three are in lateral at 50 mm from the wall of the secondary reactor's tank.

In figures 3-8 reaction rates for gypsum forming are presented after all six axes described above.

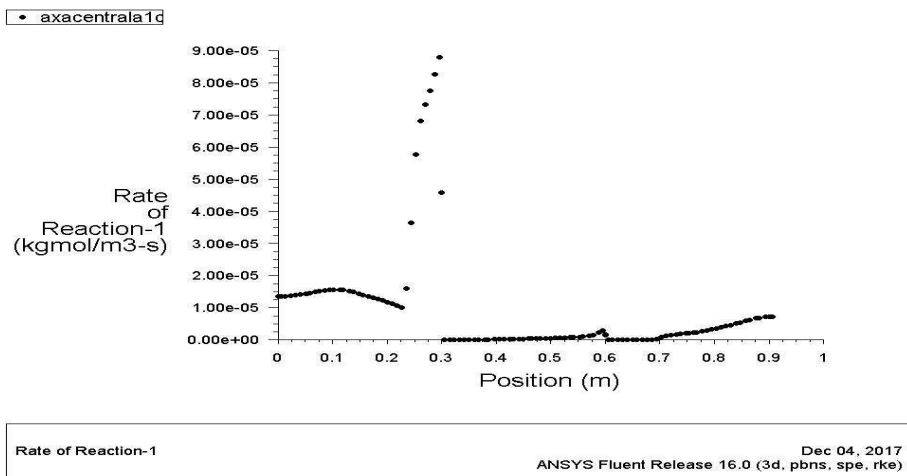
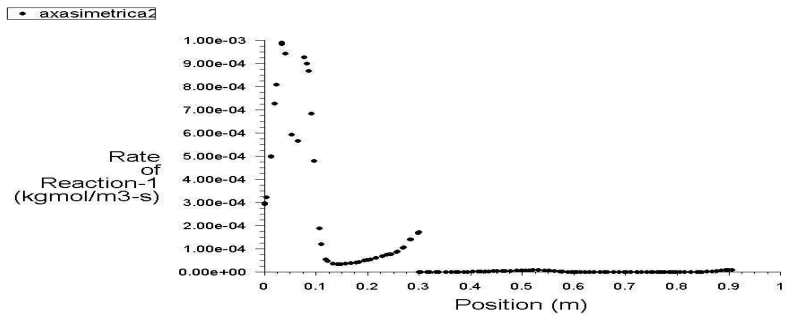
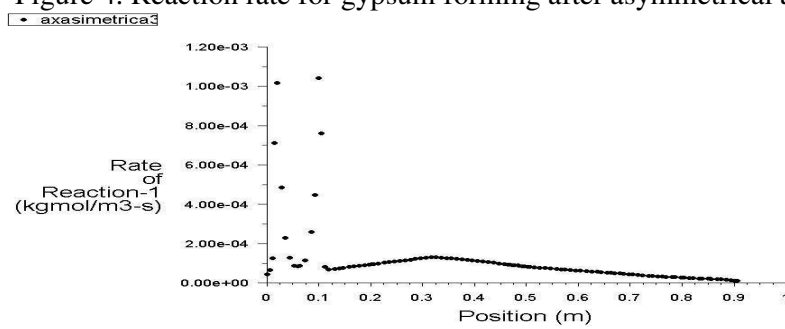

Figure 3. Reaction rate for gypsum forming after asymmetrical axis 1



Rate of Reaction-1  
ANSYS Fluent Release 16.0 (3d, pbns, spe, rke) Dec 04, 2017

Figure 4. Reaction rate for gypsum forming after asymmetrical axis 2



Rate of Reaction-1  
ANSYS Fluent Release 16.0 (3d, pbns, spe, rke) Dec 04, 2017

Figure 5. Reaction rate for gypsum forming after asymmetrical axis 3

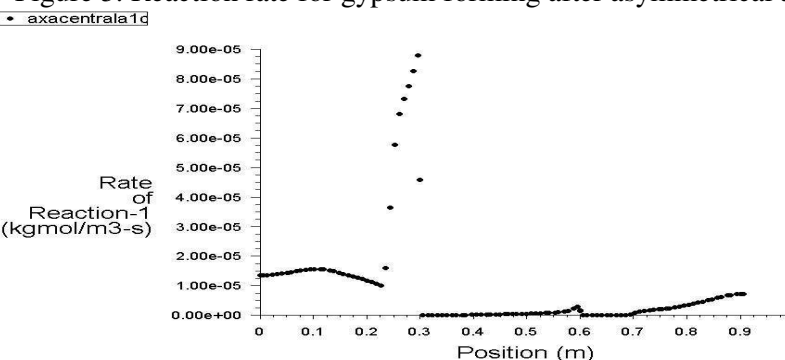

Rate of Reaction-1  
ANSYS Fluent Release 16.0 (3d, pbns, spe, rke) Dec 04, 2017

Figure 6. Reaction rate for gypsum forming after central axis 1c

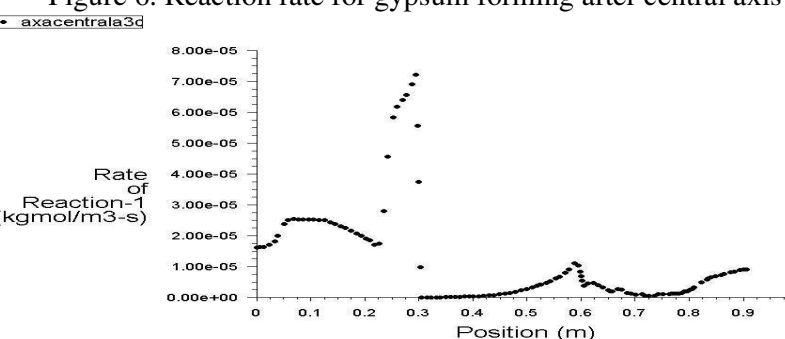

Rate of Reaction-1  
ANSYS Fluent Release 16.0 (3d, pbns, spe, rke) Dec 04, 2017

Figure 7. Reaction rate for gypsum forming after central axis 3c

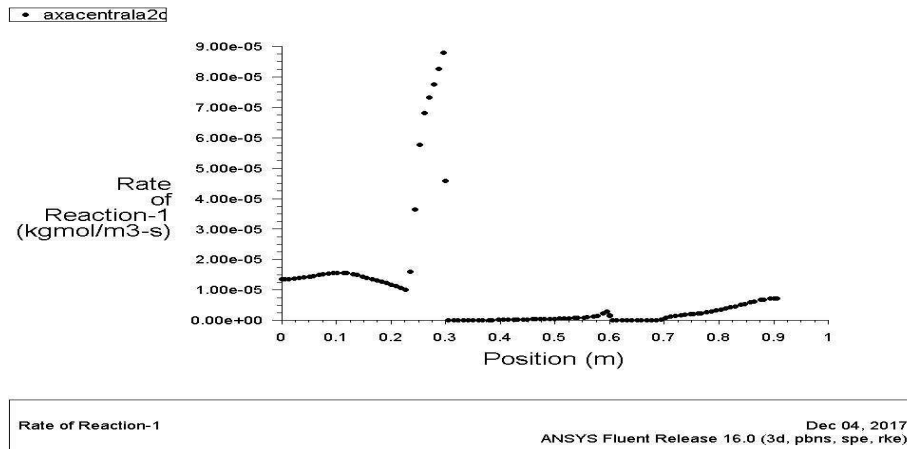

Figure 8. Reaction rate for gypsum forming after central axis 2c

Analysing the variation graphs in figures 3-8 it was observed that reaction rates are ranging between  $10^{-5} - 10^{-3}$  kmol/(m<sup>3</sup>s) values. Considering that superior values are normal and taking into consideration the concentrations of reactants for reaction 1, the need to accelerate mixing processes was observed in areas where reactions slow down below  $10^{-3}$  kmol/(m<sup>3</sup>s). This means introducing a geometrical or mechanical agitation system. In the first phase a geometrical system will be used through appropriate wall profiling considering also the flow spectrum in respective areas.

Generally, it is observed that reaction rates are higher in the first 300 mm of the tank. Also, this area is split in two regions depending on the axis out of which values were registered. This means that in the rest of areas either reactants were depleted either the way of mixing is poor. On the two subzones samples will need to be extracted in order to identify the causes that lead to their differentiation. Also, flow spectrums of reactants will need to be overlapped on the variation graphs of reaction rate to highlight the causes of divergence between the current lines of different components.

It was observed that the process in the second tank is completely without reactions. This conclusion can lead also to the idea of reducing its volume depending on the results that will be obtained from solving the first conclusions.

Currently only reaction tank 1 was considered, the one that produces calcium sulphite, as being determining and strictly necessary for second reaction taking place. Because of this reason it was considered that in this phase of the research it is sufficient to analyze the mass transfer just for the first reaction then after optimizing this process the process governing the second reaction is also optimized.

Desulphurization installation includes a first step that is represented by a vertical reactor that also contains a scrubber and then the second step that is represented by a tank meant for finalizing the chemical reactions and settling the water compared with the gypsum solution.

The issues that are followed by the numerical modelling – in this step – are represented by determining the flow rate, temperatures and pressure regime that must be kept in the second step of the installation in order to obtain higher concentrations of gypsum in aqueous solution.

Modelling the tank that represents the second step was done according to figure 9.

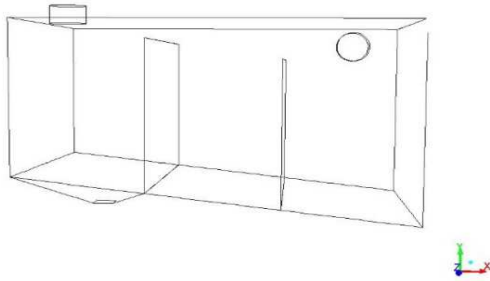

Figure 9. Geometrical model of reactor's second step

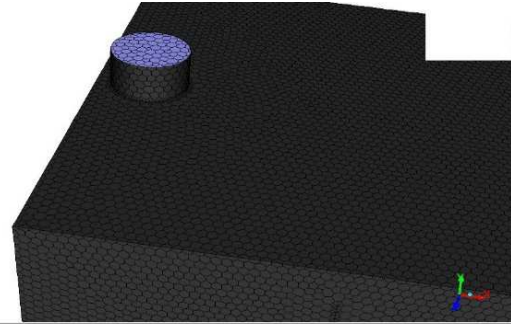

Figure 10. Modelling with hexahedral synthesis elements of reactor's second step

Modelling was based on a discretization in a number of approximately 1.5 million pyramidal elements. For a reduction of calculation volume, it was chosen to group the pyramidal elements into hexahedral elements according to figure 10.

The process inside step two of the installation consists in the penetration of a gas-water emulsion composed of nitrogen, carbon dioxide, oxygen, sulphur dioxide, and water as liquid.

This emulsion was introduced with a rate of 0.7 m/s to not generate a higher turbulence and to disturb the settling process. The emulsion flow was correlated for an average equivalent regime of the pilot burning point of 750 kWt. After performing numerical simulation tests the following results were obtained regarding gypsum formation, as it is observed in figure 11-13.

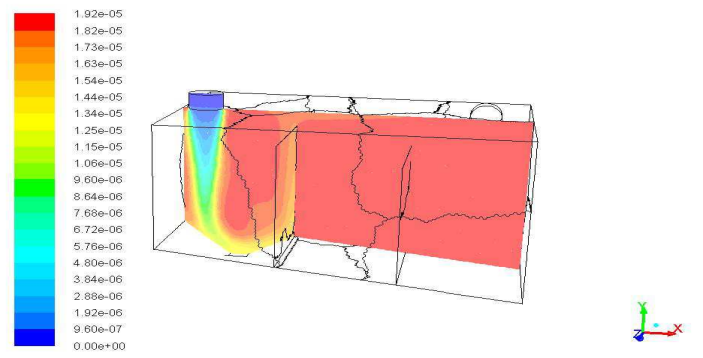

Figure 11. Late formation of gypsum.

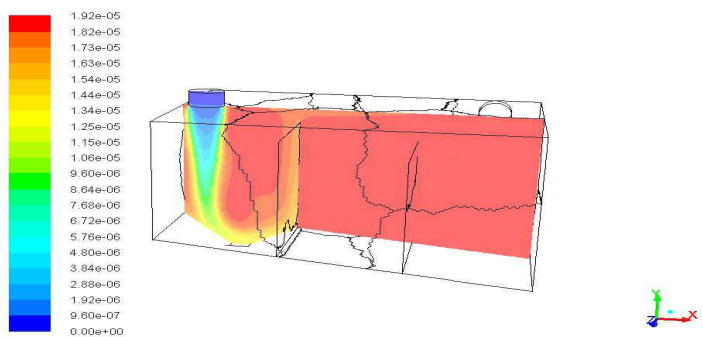

Figure 12. Rapid formation of gypsum at high turbulence.

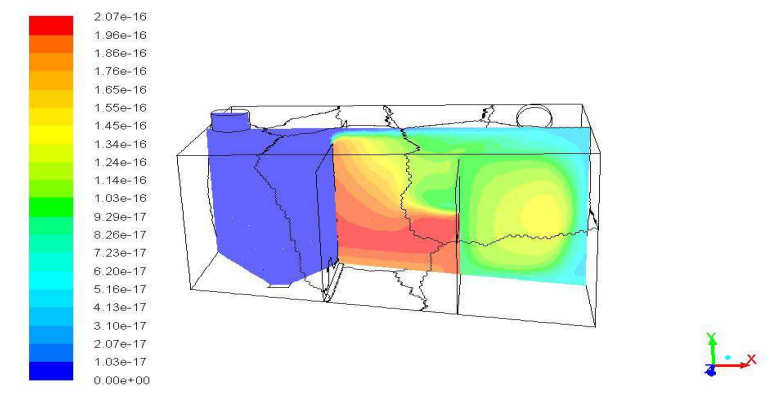

Figure 13. Normal formation of gypsum.

### 3. CONCLUSIONS

In figure 11 we can see the gypsum is formed late and settling will be difficult to be achieved. In figure 16 gypsum is formed immediately but this is due to a turbulence increase, which makes the separation difficult. In figure 17 a normal gypsum formation process is observed which allows its settling in good conditions.

#### *Acknowledgement*

*This work was supported by a grant of the Romanian National Authority for Scientific Research and Innovation, CNCS/CCCDI – UEFISCDI, project number PN-III-P2-2.1-PED-2016-0867, within PNCDI III.*

#### **References**

- [1] R. Lisnic, S. I. Jinga, Study on current state and future trends of flue gas desulphurization technologies: a review, *Romanian Journal of Materials* 2018, **48** (1), 83 – 90
- [2] Patricia Córdoba, Status of Flue Gas Desulphurisation (FGD) systems from coal-fired power plants: Overview of the physic-chemical control processes of wet limestone FGDs, *Fuel*, Vol. **144**, March 2015, 274-286
- [3] Sectorial Guidelines for EIA: Projects for Flue Gas Desulphurization Installations in large combustion plants, Joint Assistance to Support Projects in European Regions, Romania, 2014
- [4] A-M Dragomir, R. Lisnic, T. Prisecaru, M. M. Prisecaru, C. A. Vîjjan, D. C. Năstac, Study on synthetic gypsum obtained from wet flue gas desulphurisation in thermal power plants, *Romanian Journal of Materials* 2017, **47** (4), 551 – 556
- [5] M. Ploscaru, A.S. Sandulescu, Studiu privind utilizarea tehnologiilor de desulfurare la CTE din bazinul Oltenia, SERMSTudo, CD-ROM, ISBN:978-606-10-0592-5, 2013
- [6] Flue gas desulphurization wet limestone-gypsum process, KC Cottrell Co., Ltd., 2016
- [7] M. C. Caillaud, F. J. Moura, Technical feasibility for use of FGD gypsum as an additive setting time retarder for Portland cement, *Journal of Material Research and Technology*, 2017
- [8] G. Tzouvalas, G. Rantis, S. Tsimas, Alternative calcium-sulfate-bearing materials as cement retarders: Part II. FGD gypsum, *Cement and Concrete Research*, **34** (11), 119-125, 2004
- [9] R. P. Borg, C. Briguglio, V. Bocullo, D. Vaičiukynienė, Preliminary investigation of geopolymer binder from waste materials, *Romanian Journal of Materials* 2017, **47**(3),370-378

# ENERGETIC PERFORMANCE INCREASE OF AN ENGINE-ELECTRIC GENERATOR GROUP

Radoescu Petrisor<sup>1</sup>, Pana Constantin, Negurescu Niculae, Cernat Alexandru, Nutu Cristian

University Politehnica of Bucharest

## ABSTRACT

The main objective of the paper is the energetic performance increase of a diesel engine that drives an electric generator, the engine-generator group being destined to be used in isolated areas.

In this sense, the authors recommend two solutions: the use of LPG as fuel for engine and the use of heat from the engine cooling and exhaust gas systems for domestic hot water / heating for a single dwelling place. Because of the high self-ignition resistance of LPG (CN = -2 ... 3) a diesel engine with the displacement of 2,216 L was converted into a spark ignition engine, the compression ratio being reduced from 23.3: 1 to 12.25: 1. A simulation of the thermo-gas dynamics processes into engine cylinder with AVL Boost software has been carried to highlight the LPG influences on engine operation. The results of the modeling revealed both the increase of engine thermal efficiency as and the sharp reduction of the pollutants emissions, especially the NO<sub>x</sub> concentration.

## 1. INTRODUCTION

The energetic performance increase of a diesel engine that drives an electric generator can be achieved by next solutions use: the use of LPG as unique fuel and use of heat from the engine cooling and exhaust gas systems for domestic hot water / heating for a single dwelling place.

The use of LPG at the diesel engine is recommended for the fossil fuels replacing and for the pollutants emissions level decrease. The LPG is a good alternative fuel for diesel engine due to the following aspects [1], [2]: the NO<sub>x</sub> emission level is lower; CO<sub>2</sub> emission is maintained to the same level; the engine power is the same or can increase; the HC and CO emissions level decreases; the infrastructure for LPG distribution already exists [3].

Because the high self-ignition resistance of LPG is lower (CN = -2 ... 3) the LPG diesel engine fuelling can be achieved by the next methods: diesel –gas method or its converting in a spark ignition engine [3]. At the first method use, LPG is injected in gaseous phase in the engine intake and one pilot of diesel fuel is injected into combustion chamber assuring the ignition of the air-LPG mixture and the flame propagates in this mixture [3]. At the second method use, the diesel engine is converted in a spark ignition engine, the compression ratio being reduced but LPG is a single fuel [4]. The researches were works performed at University POLITEHNICA from Bucharest on an automotive diesel engine with LPG fuelled by diesel-gas. The experimental investigations results showed the NO<sub>x</sub> and smoke emissions level decrease (NO<sub>x</sub> emissions level decreases with 35 % and smoke emission decreases with 40 % ) comparative to diesel fuelling [3, 4].

The paper presents some theoretical results obtained by authors from a research developed for a diesel engine converted in ignition spark ignition fuelled wit LPG. Are presented influences of the LPG upon energetic and pollution performance. For the recovery of heat from the engine cooling system (~ 15% of the available heat) and the exhaust gases (~ 40% of the available heat) the authors recommend the construction of a system consisting of appropriately sized heat exchangers, [5].

---

<sup>1</sup>Blvd. Splaiul Independentei no. 313, +40721208201, office@generator.ro

The engine-electric generator group solution designed by the authors is viable both in terms of energy efficiency and reliability.

## 2. METHODOLOGY

The theoretical researches were carried on an engine with 2.216 L displacement, type KVT-E22 SI at the full load and 1500 rpm for different air excess ratio. The engine was obtained by converting a diesel engine, type Perkins with the compression ratio 22.5:1 in a spark ignition engine with the compression ratio 12.25:1. A simulation of the thermo-gas dynamics processes into engine cylinder with AVL Boost software has been carried to highlight the LPG influences on engine operation.

The engine was firstly fuelled with compression natural gas (CNG) and then with liquefied petroleum gas (LPG) for the same ignition timing - 24 °CA.

The results of theoretical investigations present some the energetically performance and pollution engine performance.

At full load and 1500 rpm the engine power fuelled with CNG or LPG has same value for the theoretic dosage, figure 1.

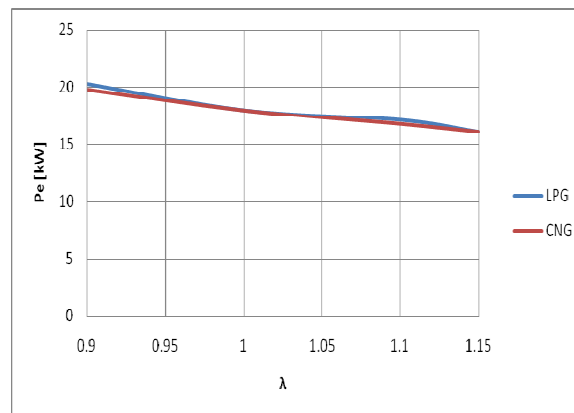

Figure 1: The engine power versus air excess ratio at 1500 rpm and 100% load

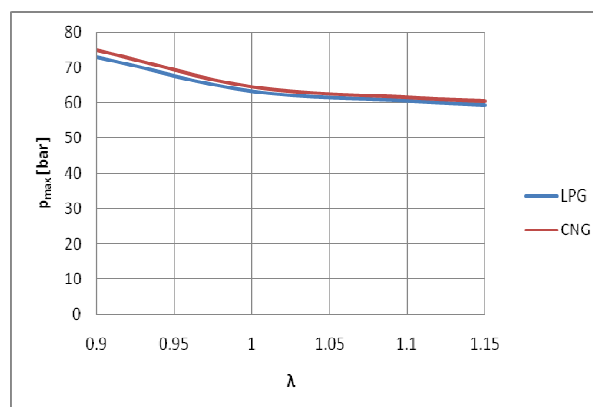

Figure 2: The maximum pressure versus air excess ratio at 1500 rpm and 100% load

At the CNG use the maximum pressure and the maximum pressure rise rate slight increase due to easy smaller heat release on volume unit, figures 2 and 3.

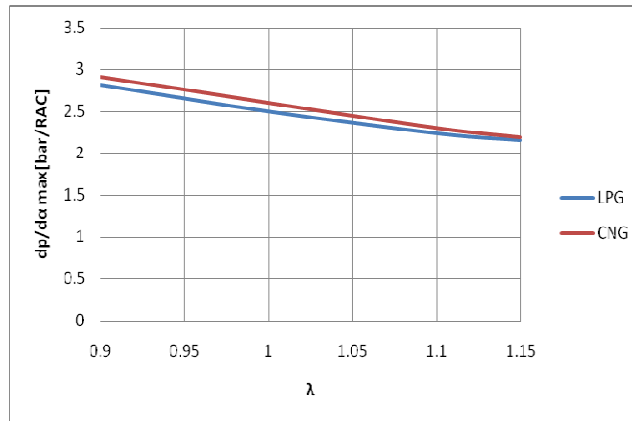

Figure 3: The maximum rate rise pressure versus air excess ratio at 1500 rpm and 100% load

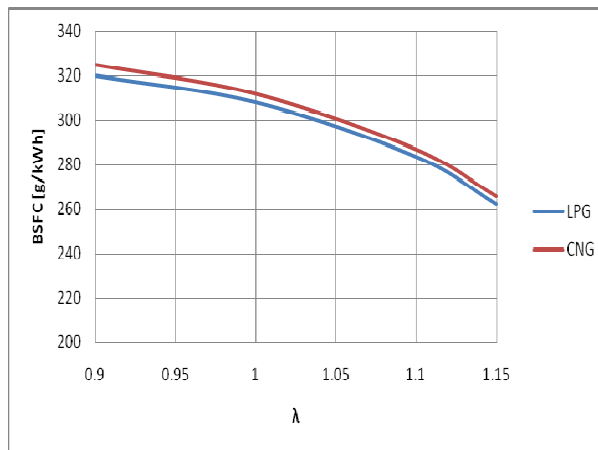

Figure 4: Brake specific fuel consumption versus air excess ratio at 1500 rpm and 100% load

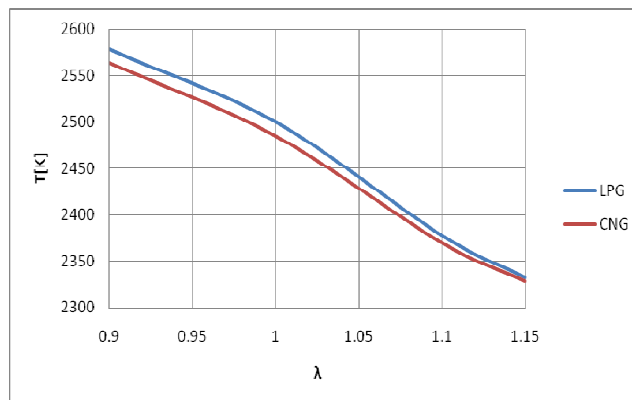

Figure 5: The gas temperature versus air excess ratio at 1500 rpm and 100% load



In the figure 4 is presented the brake specific fuel consumption (BSFC) variation with the air excess ratio. At the CNG engine fuelled, BSFC slight increases due to its smaller combustion rate comparative with LPG. The NO<sub>x</sub> emission level is smaller at the CNG engine fuelled, figure 6 because the gas temperature decreases, figure 5 (the flame temperature is smaller for CNG).

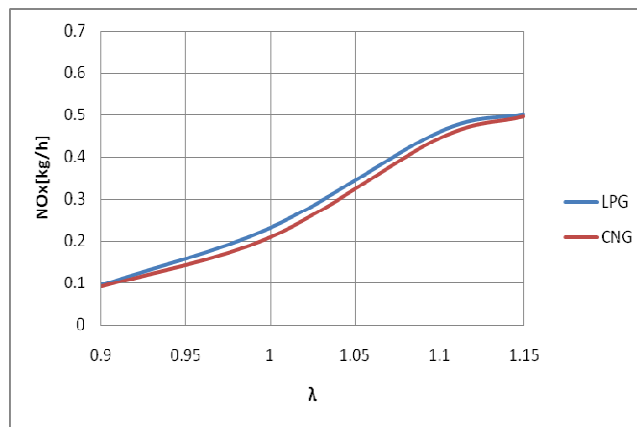

Figure 6: NO<sub>x</sub> emissions level versus air excess ratio at 1500 rpm and 100% load

### 3. CONCLUSIONS

The theoretical study shows the main characteristics of the spark ignition engine converted from diesel engine running at the fuelling with LPG. Use of LPG for engine fuelling assures its energetic performance impromevent without constructive modifications comparative to CNG use. Another advantage of LPG use is the distribution infrastructure developed.

### ACKNOWLEDGMENTS

The authors address special thanks to AVL GmbH Graz Austria for providing the necessary equipments. The work has been funded:

- by a grant of the Romanian Ministry of Research and Innovation, CCCDI-UEFSCDI, project number PN-III-P1-1.2-PCCDI-2017-0404/31PCCDI/2018 , within PNCDI III”
- by University Politehnica of Bucharest, through the “Excellence Research Grants” Program, UPB – GEX 2017. Identifier: UPB- GEX2017, Ctr. No. 62 /2017

### References

- [1] Vijayabalan, P., Nagarajan, G., “*Performance, Emission and Combustion of LPG Diesel Dual Fuel Engine using Glow Plug*”, in <http://jjmie.hu.edu.jo>
- [2] Pana, C., Negurescu, N., Popa, M.G., Cernat, A., Despa, P., Bujgoi, Fl., “Aspects of the LPG Use in Diesel Engine by Diesel-Gas Method”, FISITA World 2008, Munchen, 2008.
- [3] Pana, C., Negurescu, N., Popa, M. G., Cernat, A., “*LPG – Ecological Fuel for Automotive Diesel Engine*”, – “CONAT 2010 –International Congres son Automotive and Transport Engineering”, –Proceedings Volume III, Automotive Vehicles and Environment, pp 55-64, ISSN 2069-0401, 2010.
- [4] Pană, C., Negurescu, N., Popa, M.G., Racovitză, A., Boboc, G., *Improvement of Heavy-duty Diesel Engine Operation When Using Methanol-Diesel Double Injection Fueling Method* , 5<sup>th</sup> International Colloquium FUELS 2005”, January 12-13, 2005, Technische Akademie Esslingen, Germania, ISBN 3-924813-59-0, pp.137 -142, 2005.
- [5] \*\*\*pliant-gas-chp-10--72-kWe-2015-R1.pdf, by [www.zyraxes.ro](http://www.zyraxes.ro)

# ON THE WAY TO APPROXIMATE DIESEL ENGINES EMISSIONS: A LITERATURE REVIEW

Bogdan Radu<sup>1</sup> and Alexandru Racovitză<sup>2</sup>

University "POLITEHNICA" Bucharest, Faculty of Mechanical Engineering  
Dept. of Thermodynamics, Engines, Thermal and Refrigerant Machines

## ABSTRACT

There is a wide-spread and highly motivated preoccupation in order to offer new perspectives on limiting the main emissions of Diesel engines. Many researchers try to give a global solution concerning a multi-valuable model in predicting the emissions' genesis as a result of engine processes development. The effective measurement of emissions is basically a slow procedure, depending on a large number of variables and featuring a limited precision. Therefore, simulation models and results based on approximation functions as variations of the most sensitive engine factors could be preferable for the combustion process control. The proposed paper is offering a review of these solutions based on highly advanced modeling programs, proposed by certain authors. Finding optimal methods to adjust the combustion for reaching desirable efficiency and emissions results is presumed to highlight itself as the main goal of the presented work.

**Key Words:** Diesel Engine, Combustion and Emissions Control, Advanced Simulation, Efficiency

## 1. INTRODUCTION

Numerous research activities have strongly certified that modern Diesel engines are to accomplish complex and meanwhile opposite aims not only in stationary, but mainly in transient operating conditions, meaning that they are requested to rate high performance, to generate low emissions and featuring high operation efficiency.

The allowable limits for NO<sub>x</sub> and soot Diesel emissions have drastically decreased from Euro 1 down to Euro 6d standards, despite the fact that representative driving cycles have not significantly changed related to the applied technology update, such as the use of Diesel Oxidation Catalyst, Cooled EGR, Diesel Particulate Filter or Lean NO<sub>x</sub> Trap [1]. In order that Diesel engines main simulation emissions comply with those of real drive measurement, engines calibration made in the area of steady-state speeds and loads must extend upon the driving transient behavior, driver disturbances and transient ambient conditions.

Corresponding to a first view, phenomenological models may predict the values for the indicated mean effective pressure (IMEP) according to the rated torque and to the NO<sub>x</sub> and smoke emissions on a cycle-by-cycle analysis. Results show a well prediction for the emissions resulted from stationary operating conditions (speeds within 1500 and 3000 rpm and IMEP values between 2.5 and 7.5 bar) and a slight deviation in case of smoke emissions for transient operation, explained by a low pass characteristics of the measurement apparatus

---

<sup>1</sup> Assoc. Prof., PhD, Eng, 313 Splaiul Independentei, sect.6, 060042, Bucharest, tel.: 0040-21-4029451,  
e-mail: bobitaradu@yahoo.com

<sup>2</sup> Sr. Lect., PhD, Eng, 313 Splaiul Independentei, sect.6, 060042, Bucharest, tel.: 0040-21-4029451,  
e-mail: racovitzaalexandru@gmail.com

[2,3]. Following these ideas, charting engine maps of fuel use according to imposed values for performance and emissions referring to transient driving cycles' conditions is a novel way to cover a range of various vehicles operation. Thus, the availability of accurate engine maps across a number of vehicles (DAF, Chevrolet Cruze and Volkswagen Golf) has been verified under specific conditions, like those stipulated by the main Urban Dynamometer Driving Schedule (UDDS), by Federal Test Procedure (FTP), Highway Fuel Economy Test (HWFET) and by the high speed and aggressive US06 driving cycle [4]. These maps include: the insights into how control technologies can be tuned to reduce emissions under real driving conditions, the development of the in-use emissions factors, the identification of driving conditions corresponding to the most significant and incidental of fuel use and emissions events and the adjustment of the air-fuel mixture formation, using simulated per second emissions for vehicles operating in the urban environment or on certain road segments.

An example of a new strategy calculates set points for the Engine Management System (EMS) for controllable fuel quantities with the purpose to minimize fuel consumption for a given engine speed and requested torque profile, while keeping accumulated emissions below given limits. There were followed three (EMS) evaluating approaches, using a complete Diesel engine vehicle system model and simulating the NEDC driving cycle (the injected fuel varied from 0 to 35 mg, while speed values were taken between 750 and 2250 rpm): one is based on the steady-state methodology and two others use explicit transient compensations in terms of boost pressure and Oxygen fractions as feedback signals [5]; the conclusions were that large differences were noticed between the first and those last approaches while small differences were characterizing the results in-between the transient approaches. Much further, following the new 5-cylinders Volvo Diesel (2-liters) engine testing, a globally optimized, smoothed and regressive parameter based B-Spline function was applied in order to fit data measured in static conditions, with engine speed and injected fuel as input signals [6]. It was noticed that under the transient driving conditions the developed model was able to replicate only partially the emissions results.

For real-time applications, it is not reasonable to model the emissions only by phenomenological models, because of the large complexity of the physical and chemical reactions in the cylinder of an ECU-controlled engine. Therefore, beside phenomenological and map-based models there are semi-empirical models concerning NO<sub>x</sub> and soot estimation. These ones are based on polynomial functions, where the influence of each input parameter should be known from steady-state engine behavior [7,8,9].

There are also other modeling techniques called Artificial Neural Networks (ANN), developed as parallel processing algorithms, such as Multi-Layer Perceptron (MLP)[10], or Time-Delay Recurrent (TDNN) [11]. These networks rely upon each input data to be labeled with a target output to achieve. For a given structure, a network algorithm can be expressed by an equation whose parameters are calculated by a training process. Training a neural network means to involve input patterns from which particular adjustments derive, based on the performance of the network in that point of time [12,13]. One more example consists in the use of a Self Organizing Map (SOM). One of the SOM's advantages is the fact that the distribution of the "neurons" can be adjusted according to the requirements of the given task. It covers also statistics, signal processing and control theory [14].

Next paragraph is offering an analysis of various functions to determine emissions values, using experimental data and results obtained by advanced modeling programs. Finding certain methods to adjust the combustion for reaching desirable efficiency and emissions results represents also another goal of the presented work.

## 2. MATHEMATICAL MODELS TO EXPRESS THE EMISSIONS

The theoretical calculation of nitrogen oxides and soot formation is a far complicated issue, due not only to their genesis mechanism, largely known, but mostly because to the fact that these reactions occur in very special zones of the combustion chamber. There are two empirical formulas based on a large number of experiments in order to evaluate the two type emissions as a function of the cylinder conditions and the pressure diagram characteristics [15,16]:

$$\text{Soot (smoke number)} = K_1 \times ZV^{\alpha_1} \times \alpha_1^{\alpha_2} \times \left(\frac{dp}{d\phi}\right)_{\max}^{\alpha_3} \times \alpha_2^{\alpha_4} \times O_2^{\alpha_5} \times \left(\frac{m_{\text{Luft}}}{m_{\text{gesamt}}}\right)^{\alpha_6} \quad (1)$$

$$\text{NO}_x \text{ (ppm)} = K_2 \times ZV^{\beta_1} \times \alpha_1^{\beta_2} \times \left(\frac{dp}{d\phi}\right)_{\max}^{\beta_3} \times \alpha_2^{\beta_4} \times O_2^{\beta_5} \times \left(\frac{m_{\text{Luft}}}{m_{\text{gesamt}}}\right)^{\beta_6} \quad (2)$$

in which the symbols have the following meaning:  $K_1$ ,  $K_2$  are the proportionality coefficients, each for each emission type;  $ZV$  is the autoignition delay;  $\alpha_1$  is the angle formed with the horizontal axis by the line between the combustion starting point and the highest point of the heat release characteristic;  $\alpha_2$  is the angle formed with the horizontal axis by the line between the combustion ending point and the highest point of the heat release characteristic (see Figure 1);  $(dp/d\phi)_{\max}$  is the maximum rate of the pressure increase, peaked from the pressure diagram;  $O_2$  is the oxygen concentration from the exhaust gas;  $(m_{\text{air}}/m_{\text{fresh charge}})$  is the ratio between the air quantity and the entire fresh charge;

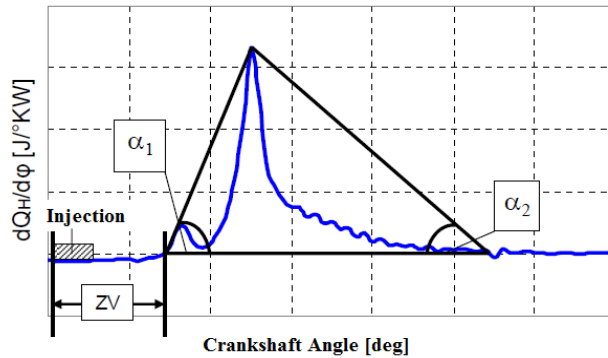

Fig.1. Diesel Engine heat release characteristic

Other studies, relying on numerous experimental points obtained by testing a 4-stroke, single cylinder, L70 Diesel engine (4,5 kW output at 3000 rpm) and fueled also by Palm-tree Oil based Biodiesel established high-confidence prediction equations for  $\text{NO}_x$  and soot formation [g/kWh], as for the engine BSFC [g/kWh] and Rated Power [kW], expressed as linear combinations between certain of the engine most influencing parameters, for each of the tested fuels (Diesel and Biodiesel) [17]:

$$\text{NO}_x, \text{Soot}, \text{BSFC}, \text{Rated Power} = F_k(ES, AF, CR, HD, RP, IT, EC, II) \quad (3)$$

in which:  $ES$  is the engine speed [rpm],  $AF$  is the air-fuel ratio [-],  $CR$  is the compression ratio [-],  $HD$  is the injector hole diameter [mm],  $RP$  is the rail pressure [bar],  $IT$  is the injection timing [°CA ATDC],  $EC$  is the exhaust valve clearance [mm] and  $II$  is the intake inner valve seat [mm].

### 3. CONCLUSIONS

Nowadays, the trend in estimating the impact of the emissions' levels is to train massive neural networks build on high-scale numbers of experimental reference points. As main variables, besides engine types and engine parameters, other completely new influences are studied, as changing driving cycles' operations and users' behavior, during non-stationary conditions.

Other conventional approaches maintain certain sorts of mathematical functions in order to provide by reasonable prediction range the emissions numbers related to particular engine types and their operation, steady-state or transient.

The authors of this proposed work inscribe all along their efforts to join nevertheless the second research point of view which is by the time well enough conclusive when reasonably limiting the more increasing number of the analysis variables.

### References

- [1] COMMUNICATION FROM THE COMMISSION TO THE EUROPEAN PARLIAMENT, THE COUNCIL, THE EUROPEAN ECONOMIC AND SOCIAL COMMITTEE AND THE COMMITTEE OF THE REGIONS CARS 2020: Action Plan for a competitive and sustainable automotive industry in Europe, <http://eur-lex.europa.eu/legal-content/EN/TXT/?uri=celex%3A52012DC0636>
- [2] Makovicki, T., Bitzer, M., Kotman, P., Graichen, K. – *A Combustion Cycle Model for Stationary and Transient Engine Operation*, IFAC Papers OnLine 49-11 (2016), pp.469-475.
- [3] Makovicki, T., Bitzer, M., Godde, S., Graichen, K. – *Cycle-by-Cycle Optimization of the Combustion During Transient Engine Operation*, IFAC – Papers OnLine, 50-1 (2017), pp.11046-11051.
- [4] Bishop, J.D.K., Stettler, M.E.J., Molden, N., Boies, A.M. – *Engine Maps of Fuel Use and Emissions from Transient Driving Cycles* – ELSEVIER Applied Energy 183 (2016), pp.202-217.
- [5] Grahn, M., Johansson, K., McKelvey, T. – *A Transient Diesel EMS Strategy for Online Implementation*, Proceedings of the 19-th World Congress of IFAC, Cape Town, South Africa, August 24-29, 2014, pp.11842-11847.
- [6] Velmurugan, D.V., Grahn, M., McKelvey, T. – *Diesel Engine Emissions Model Transient Cycle Validation*, IFAC Papers OnLine, 49-11 (2016), pp.001-007.
- [7] Tschanz, F., Amstutz, A., Onder, C.H., Guzzella, L. – *A Real-time Soot Model for Emissions Control of a Diesel Engine*, 6-th IFAC Symposium of Advances in Automotive Control, 2010, pp.222-227.
- [8] Mrosek, M., Sequenz, H., Isermann, R. – *Control Oriented NO<sub>x</sub> and Soot Models for Diesel Engines*, 6-th IFAC Symposium of Advances in Automotive Control, 2010, pp.234-239.
- [9] Tschanz, F., Amstutz, A., Guzzella, L., Barro, C., Obrecht, P., Boulouchos, K. – *Control of the PM and NO<sub>x</sub> Emissions in Diesel Engines Using a Virtual Soot Sensor* – 21-st Aachen Colloquium in Automobile and Engine Technology, 2012, pp.1261-1286.
- [10] [https://en.wikipedia.org/wiki/Multilayer\\_perceptron](https://en.wikipedia.org/wiki/Multilayer_perceptron)
- [11] [https://en.wikipedia.org/wiki/Time\\_delay\\_neural\\_network](https://en.wikipedia.org/wiki/Time_delay_neural_network)
- [12] Arsie, I., Marra, D., Pianese, C., Sorrentino, M. – *Real-time Estimation of Engine NO<sub>x</sub> Emissions via Recurrent Neural Networks*, 6-th IFAC Symposium of Advances in Automotive Control, 2010, pp.228-233.
- [13] Henningson, M., Tunestal, P., Johansson, R. – *A Virtual Sensor for Predicting Diesel Engine Emissions from Cylinder Pressure Data*, 2012 IFAC Workshop on Engine and Powertrain Control, Simulation and Modelling, pp.424-431.
- [14] Fischer, M. – *Transient NO<sub>x</sub> Estimation Using Artificial Neural Networks*, The 7-th IFAC Symposium on Advances in Automotive Control, Sept.4-7, 2013, Tokyo, Japan, pp.101-106.
- [15] Wenzel, S.,P., *Modellierung der Russ und NO<sub>x</sub> Emissionen des Dieselmotors*, Dissertation zur Erlangung des akademischen Grades Doktoringenieur, Magdeburg Universitat 2006.
- [16] Radu, B., Chiriac, R., Racovitza, A., *Soot and smoke emissions numerical evaluation for a direct injection (DI) Diesel engine*, MSE International Conference, June 2017, ULBS, Sibiu, ROMANIA.
- [17] Jo-Han, Ng., Jing, H.K., Wong, K.W., Srithar, R., Chang, C.T., *Statistical Analysis of Engine System-Level Factors for Palm Biodiesel Fueled Diesel Engine Responses*, The 7-th International Conference of Applied Energy – ICAE 2015, Energy Procedia 75(2015), pp.99-104

# RESULTS FROM AN ENERGY AUDIT OF A JOINT-STOCK COMPANY “MEDICA AD”, BULGARIA

Violeta Rasheva<sup>1</sup>, Veselka Kamburova<sup>2</sup>, Michail Velikanov<sup>3</sup>

<sup>1</sup>University of Food Technologies, Bulgaria, <sup>2</sup>University of Ruse “Angel Kanchev”, Bulgaria;  
<sup>3</sup>Encon Services International, USA

## ABSTRACT

The proposed energy efficiency project includes modernization of the indoor air conditioning and ventilation systems and a solar water heating system in company produces medical supplies. Some of the company’s main products include band-aids and bandages. The total investment is EUR 560,136. As a result of the investment, the energy usage declines by 413 MWh per year or by 35,4% and CO<sub>2</sub> emissions decline by 159 tons CO<sub>2</sub> per year or by 32,2%.

## 1. INTRODUCTION

Europe's energy policy forms part of the overall objectives of the EU's economic policy. The starting points of the European energy policy are three: limiting climate change, promoting growth and jobs, and limiting EU dependence on imported natural gas and petroleum products. European policy is geared towards ensuring security of energy supply and introducing an integrated approach to energy efficiency. Energy saving is the most direct and economically effective way to address these energy challenges [13 , 14]. That is why the Bulgarian national policy follows the priorities and the long-term goals of the European policy for sustainable energy development [4, 5].

**The aim** of this study is to establish the possibilities for reduction of energy consumption and CO<sub>2</sub> emissions in “Medica JSC” through implementation of appropriate cost effective energy conservation measures (ECM) and to ensure the normative parameters in the working premises.

## 2. METHODOLOGY

The subject of study is the pharmaceutical company “Medica JSC”. The company is located in the town of Sandanski, located in southwestern Bulgaria, about 156 km away from Sofia. Some of the company’s main products include band-aids and bandages. The company is a legal entity with an annual turnover of EUR 9,635,807 and total assets of EUR 13,771,647. The total number of staff is 236. The company is classified as a SME.

The one-storey building occupies an area of 1,811 m<sup>2</sup> and the heated volume of the building is 5,434 m<sup>3</sup>. The energy audit and model study of the building was done according to the standardized method for determination of annual energy consumption in buildings BDS EN 13790 and was carried out with EAB software in compliance with the normative documents in the field of energy efficiency [3, 8, 9, 10, 11]. The conversion factor of final energy to primary energy is 3 for electricity and 1.1 for LPG and conversion factor of final energy to CO<sub>2</sub> emissions is 0.683 tCO<sub>2</sub>/MWh for electricity and 0.272 tCO<sub>2</sub>/MWh for LPG [1, 6].

For the purpose of the model study, the building is considered an integrated system with the main components: building envelope structures and elements, microclimate maintenance systems, internal heat sources, occupants and climatic conditions [2, 3, 7].

---

<sup>1</sup>Professor PhD University of Food Technologies, Bulgaria; tel:+359897910737; e-mail: v\_rasheva@abv.bg

### 3. ANALYSIS OF THE TECHNICAL CONDITIONS AND OPERATION OF BUILDING AND EQUIPMENT INSTALLED IN IT

Energy consumption: "Medica JSC" consumes electricity and LPG (propane-butane). The analysis of energy consumption is based on data provided by the accounting department of the company. The annual energy consumption for the period 2011 - 2013 is presented in Table 1. Fig. 1 shows the monthly distribution of the electricity consumed for the same period. The monthly consumption of LPG for the period 2011 - 2013 is presented in Fig. 2.

Table 1: The electricity and LPG consumption for the period 2011 - 2013

Year	Electricity	propane-butane
	MWh/year	t/year
2011	1,522,922	77.48
2012	1,785,955	98.18
2013	1,597,384	70.50

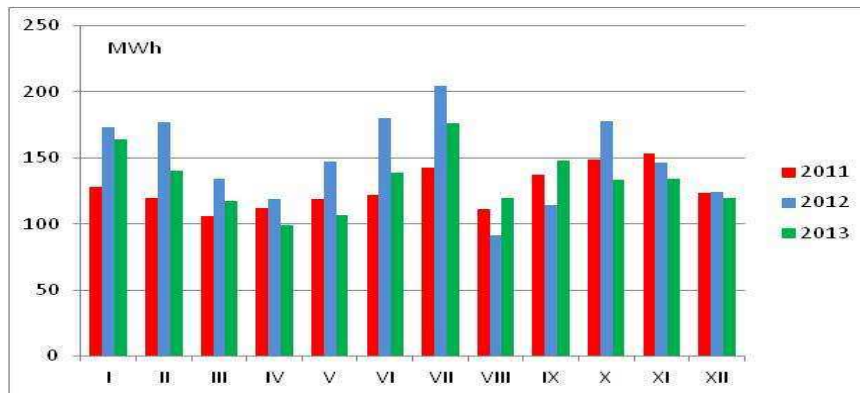

Figure 1: Electricity monthly consumption for the period 2011 - 2013



Figure 2: LPG monthly consumption for the period 2011 - 2013

The highest electricity consumption is observed during the summer months (June and July), which is related to the air conditioning of the work premises. In August, most of the staff has its annual leave, and some of the work premises do not work for a certain amount of time, that is why less energy is consumed during this month. Energy consumption during the winter months (January and February) rises due to lower outside temperatures. In December, the energy consumption is lower than in other winter months due to the closure of work premises for Christmas and New Year holidays.

LPG as an energy carrier is used to produce steam with the parameters required for the technological lines. Besides for industrial purposes, heat is also consumed for heating and domestic hot water (DHW). The analysis of LPG consumption for the 2011-2013 period shows that the smallest consumption is in August, which is related to the staff annual leave and shutdown the equipments for a certain amount of time. The biggest consumption of LPG is in winter months when the heat produced by boilers is used for premises heating.

The building and the production facility operates 5 days per week for 9 hours per day. It is heated using an existing propane-butane fired steam boiler (efficiency assumed to be 90%). The building's design indoor temperature during the heating season is +22°C. The company uses the existing LPG fired boiler for heating DHW. The estimated energy consumption for heating is 16,936 kWh per year (or 18,630 kWh/yr. primary energy equivalents).

The building is cooled using the existing ventilation and air conditioning system (for cooling only, EER=2.2 W/W). The building's design indoor temperature during the cooling season is +25°C. Various production areas have different requirements for air purity and air exchange. The mounted ventilation system has a total fans output of 137 kW.

The building interior is lit by luminescent and halogen lamps, depending on the desired light conditions in each specific production area. The total installed lighting capacity is 18.382 kW.

The annual energy use for space heating is estimated to be 184,460 kWh. The annual energy use for heating the fresh air for ventilation is estimated to be 537,489 kWh or in total 722,309 kWh/yr. energy from LPG and 794,540 kWh in primary energy equivalents.

The annual energy use for cooling is estimated to be 51,275 kWh. The annual energy use for cooling the fresh air for ventilation is estimated to be 376,432 kWh or in total 427,707 kWh/yr. of in primary energy equivalents 1,283,121 kWh/yr.

The existing system's estimated total annual energy consumption for all the systems is 1,166,952 kWh (or 2,096,291 kWh/yr. of primary energy). The annual CO<sub>2</sub> emissions are 488.59 tons. The data of present energy consumption are presented in Table 2.

Table 2: Present energy consumption

Sector	Energy consumption	Primary Energy Consumption	CO <sub>2</sub> Emissions
-	kWh/yr.	kWh/yr.	t <sub>CO2</sub> /yr.
Heating	722,309	794,540	196.5
Cooling	427,707	1,283,121	292.1
Domestic hot water	16,936	18,630	4.61
Total	1,166,952	2,096,291	493.2

**Building envelope:** *The outside walls* of the building are constructed of thermo-insulated panels made of an insulating material, covered by inner and outer metal sheets.

*The floor* of the building is made of reinforced concrete plates, which are 15 cm thick. Under the plates is a layer of rammed earth (15 cm in thick).

*The roof* is made of insulated plates. There is hydro-insulation installed on the outer side of the plates.

*The windows and the doors:* The building's windows have PVC frames and double glazing. The total area of the windows is 13 m<sup>2</sup>. There are two doors with PVC frames with insulating material between the frames. The total area of these doors is 15 m<sup>2</sup>.

In general, the condition of the building shell (facades, floor, roofs and windows) is good. The building shell's heat transfer coefficients do meet the current requirements, set on [12].

The area, the heat transfer coefficients and direction of the elements of the building shell are presented in Table 3.



Table 3: The area, the heat transfer coefficients and direction of the building shell elements

Building shell elements	U values	Directions			
		south-east	north-east	south- west	north-west
	W/m <sup>2</sup> K	m <sup>2</sup>			
Walls	0.20	309	87	90	296
Windows	2.25	6	3	0	4
Doors	2.70	0	0	0	15
Floor	1.00	1,811			
Roof	0.35	1,811			

#### 4. SUGGESTIONS FOR ENERGY EFFICIENCY IMPROVING

Two energy saving measures (ECM) are foreseen:

##### **ECM 1: Replacement of air conditioning and ventilation system**

The building has an existing heating, ventilation and air conditioning system (HVAC), but it has not been renovated since it was first installed in 2002. It does not meet the modern requirements for thermal comfort and process conditions, which is why its replacement is recommended. There is no system for recovery of exhaust air.

The installation of heat exchangers for heat recuperation will reduce the cost of building heating and cooling. The project envisages renovating and replacing portions of the building's space heating, water heating and cooling and ventilation systems as well as installation of a new modern building management system.

The company intends to reduce the energy consumption of the building by installing: New chiller; New ceiling-mounted four way convection units; New ventilation grids; New Building Monitoring System (BMS) for monitoring and controlling the building's indoor climate systems; New piping required to ensure the normal functioning of the new convection units; New ventilation air-preparation units for the different indoor climate zones; Heat recovery unit; New auxiliary items, needed for normal functioning of the new systems

The project will replace the existing chiller system and will include all the necessary auxiliary piping and control systems, as well as indoor cooling and heating units. This will allow the use of a more advanced chiller, with a higher EER (Energy Efficiency Ratio). The new chiller will significantly reduce the energy required for cooling the water for air conditioning. In combination with the new and improved ventilation system the total energy consumed for air conditioning and cooling of fresh air for ventilation will decrease.

As for the building's heating needs, the project includes a heat recovery system to further reduce energy consumption. Since the company will use their existing LPG boiler the effect of the heat recovery system will be to reduce the energy consumption by preheating the fresh air with the exhaust air that would otherwise be released into the atmosphere, during the heating season.

**ECM 2: Installation of new solar collectors for DHW.** DHW for dressing rooms and other living rooms is heated with steam-water heat exchanger. That's way it is proposed to be installed solar collectors, which will lead to the saving of propane butane.

Solar panels for heating domestic water will be installed on the roof of the building, as well as all necessary system components and will decrease the energy required for heating water.

#### 5. RESULTS

According to the calculation model, after the building improvements, the annual energy consumption for heating is 185,664 kWh and for heating the fresh air is 243,431 kWh The total energy consumption for heating will decrease to 429,075 kWh/yr. or primary energy equivalent of 471,983 kWh/yr.

The energy savings from domestic hot water (DHW) after the installation of the new solar system is 6,464 kWh/yr. (or 7,110 kWh/yr. primary energy). This will result in decrease of LPG used by the boiler by 498.8 kg/yr. In addition, electricity consumption will increase due to the solar system's pump, required for its normal functioning. The amount of this increase will be 847 kWh/yr. or 2,541 kWh/yr. in primary energy.

For cooling the required energy will decrease to 37,601 kWh/yr. and for cooling the fresh air from the ventilation system - 276,050 kWh/yr. The total energy consumption for cooling will decrease to 313,651 kWh/yr. or in equivalent primary energy – 940,953 kWh/yr.

The LPG consumption will decrease to 439,547 kWh/yr. and the electricity consumption for cooling and hot water will decrease to 314,498 kWh/yr. The total energy consumption will decrease to 754,045 kWh/yr. or in equivalent primary energy to 1,424,454 kWh/yr. The total energy savings from LPG are 299,698 kWh/yr. or (329,668 kWh/yr. primary energy), while the electricity savings are 113,209 kWh/yr. The data about expected energy consumption after ECMs are presented in Table 4 and expected energy savings are presented in Table 5. The Project's cost breakdown is presented in Table 6.

Table 4: Expected energy consumption

Sector	Energy consumption	Primary Energy Consumption	CO <sub>2</sub> Emissions
-	kWh/yr.	kWh/yr.	t <sub>CO2</sub> /yr.
Heating	429,075	471,983	116.7
Cooling	313,651	940,953	214.2
Domestic hot water	11,319	14,060	3.4
Total	754,045	1,424,454	334.4

Table 5: Annual energy savings

	Final energy	Primary energy	CO <sub>2</sub> Emissions
	kWh/yr.	kWh/yr.	t <sub>CO2</sub> /yr.
Old equipment	1,166.9	2,096.3	493.2
New equipment	754.1	1,424.5	334.4
Savings	412.9	671.8	158.8
Savings	35.38 %	32.05%	32.2%

Table 6: Project Cost Breakdown

Project Costs*)	BGN	EUR
Heating and cooling centers	311,718	159,379
Solar system for DHW	8,827	4,513
Ventilation in clean rooms	153,295	78,378
Ventilation in industrial area	93,943	48,032
Ventilation in weaving section	60,661	31,015
Ventilation in storage and sterilization area	128,250	65,573
Ventilation in auxiliary rooms	14,259	7,290
Building management system (BMS)	324,579	165,955
<b>Total Project Cost</b>	<b>1,095,136</b>	<b>560,136</b>

Note: \* w/o VAT

The system will not increase production, because the proposed equipment is not related to the plant's production process.

## 6. CONCLUSIONS

An Energy Audit of "Medica JSC" was completed. The project will improve the energy efficiency of the company. The building's installations renovation will save significant amounts of energy and reduce CO<sub>2</sub> emission. For all the systems to function efficiently the project includes a new state-of-the-art building monitoring system (BMS). This will further decrease the building's energy consumption by optimizing the work regimes of the different components as well as the interactions between them.

The final energy savings from LPG are 299,698 kWh per year (or 329,668 kWh/yr. primary energy), while the final electricity savings are 113,209 kWh per year (or 339,627 kWh/yr. primary energy). The total energy savings are 412,907 kWh per year (or 671,836 kWh/yr. primary energy). Energy saving ratio is 35.4%. Energy savings were calculated using data about the working regimes of the company and electricity consumption of old and new equipment.

The CO<sub>2</sub> emissions savings from LPG are 81.52 tCO<sub>2</sub>/yr. while the CO<sub>2</sub> emissions savings from electricity are 77.32 tCO<sub>2</sub>/yr. The total CO<sub>2</sub> emissions savings are 158.84 tons per year or 32.2%.

The estimated lifetime of the implemented equipments is 15 years (based on the typical life of such equipment).

Another possibility for reduction of energy costs is the gasification of the plants. Thus, LPG, which is transported to the plant, will be replaced by natural gas.

## References

- [1] *Electricity Emission Factors Review*, November 2009, developed by MWH S.p.A и Commission Decision of 29.01.2004 Establishing guidelines for the monitoring of green house gas emissions pursuant to Directive 2003/87/EC of the European Parliament and of the Council.
- [2] Iliev, I, N. Kaloyanov, P. Gramatikov, V. Kamburova, A. Terziev, I. Palov, S. Stefanov, K. Sirakov. *Energy Efficiency and Energy Management Handbook, Bulgaria Energy Efficiency for Competitive Industry Financing Facility (BEECIFF): Project Preparation, Capacity Building and Implementation Support*. Sofia, Ministry of Economy, Energy and Tourism ("MoEET"), 2012.
- [3] Kaloianov, N., V. Sharankov and others. *Guide to Energy Efficiency Audits and Certification of Buildings*. TU - Sofia, 2006.
- [4] *Law of energetics*, <https://www.me.government.bg/bg/library/zakon-za-energetikata-256-c25-m0-1.html>
- [5] *Law on energy efficiency*, [http://www.seea.government.bg/documents/ZEE\\_30.12.2016.pdf](http://www.seea.government.bg/documents/ZEE_30.12.2016.pdf)
- [6] *Methodology for determining the harmful gases emitted into the atmosphere in balance method issued by the Ministry of Environment and Water* in 2000.
- [7] Rasheva, V., *Energy-technological analyses of industrial systems*. Academic Publishing House of UFT, Plovdiv, 2011 (in Bulgarian).
- [8] *Regulation № E- PД-04-05* of September 8, 2016 for the determination of energy consumption indicators, energy performance of enterprises, industrial systems and external lighting systems, as well as for setting the terms and conditions for conducting energy efficiency audits and preparation of energy savings assessment;
- [9] *Regulation № E-PД-04-1* of 22.01.2016 on energy efficiency audits, certification and assessment of energy savings of buildings;
- [10] *Regulation № E-PД-04-2* from 22.01.2016 on the indicators for energy consumption and energy performance of buildings;
- [11] *Regulation № PД-16-932* of 23 October 2009 on terms and conditions for carrying out the verification of energy efficiency for hot water boilers and air conditioning installations under article 27, al. 1 and article 28, al.1 of the law on energy efficiency and for establishing, maintenance and use of the basis data about them;
- [12] *Regulation № 7* of 2004 on Energy Efficiency of Buildings.
- [13] <https://ec.europa.eu/energy/en/topics/energy-strategy-and-energy-union/2030-energy-strategy>
- [14] <http://www.seea.government.bg/>

# THE USE OF LOW TEMPERATURE GEOTHERMAL ENERGY AT HISTORICAL BUILDINGS - CASE STUDY FOR A HOTEL

Paula TUDOR<sup>1</sup>, Victor-Eduard CENUȘĂ<sup>2</sup>, Diana BAN (TUȚICĂ)<sup>3</sup>, Iulian DUȚU<sup>4</sup>  
University Politehnica of Bucharest

## ABSTRACT

The use of geothermal low-temperature sources in historic buildings depends both on the geothermal potential of the area and on the restrictions imposed by the protection of the building's artistic elements. The paper presents various solutions for the heat supply of a historic building by using geothermal low temperature potential. The paper also details the results obtained from the calculation of the sizing of the floor heating system and the heat exchange surface between the geothermal fluid and the secondary fluid that transmits the heat inside the building.

## 1. INTRODUCTION

The use of renewable energies in historic buildings must take into account a number of factors including: the potential of renewable sources in the area, the climate characteristic of the area to which the building is part, the legislation on historical buildings by keeping intact the architectural elements [1, 2], the energy efficiency of the building and the search for ways to increase it [4, 5], etc. Also, the use of heat pumps increases the thermal level of heat utilization, its quantity and the possibility of using them for cooling [5]. Solutions for the production of several forms of energy need to be considered according to local requirements [6]. It is therefore necessary to carry out case studies that take into account the characteristics of each historic building and the energy potential of the area in which it falls.

## 2. CASE STUDY

The analyzed building, in the case study, is part of a tourist complex located in Baile Herculane resort, in south-western Romania. It was built in the 18th century and rebuilt in 1906. Currently, the building is declared a historic monument and is part of a rehabilitation process. In figure 1 is presented a picture that highlights both the exterior appearance of the building and the degree of degradation of the facade, as well as the size, which is done on 6 levels in the structure: basement, ground floor, mezzanine and 3 floors.

Near the building, which is part of the imperial center of the Herculane Baths, there is a source of geothermal water from two drillings with a temperature of about 55 °C. Taking into account this particularity of the site, the solutions proposed in this paper for the achievement of the heating are as follows:

A. Floor heating + radiant panels:

- floor heating, using the heat of the water from the geothermal wells;
- use of radiant panels to cover peak thermal demand;

B. Floor heating + heat pumps:

- underfloor heating, using heat from geothermal wells;

---

Splaiul Independenței 313, Bucharest, Romania, +0214029434, <sup>1</sup>[paulavoicu85@yahoo.com](mailto:paulavoicu85@yahoo.com), <sup>2</sup>[cenusa\\_victor@yahoo.com](mailto:cenusa_victor@yahoo.com),  
<sup>3</sup>[dianatutica@gmail.com](mailto:dianatutica@gmail.com), <sup>4</sup>[iulian\\_claudiu.dutu@upb.ro](mailto:iulian_claudiu.dutu@upb.ro)

- use of heat pumps to cover the peak heat demand, having as a cold source the heat of the water from the geothermal wells;

C. Heat pumps:

- use of heat pumps to cover all heat demand, having as a cold source the heat of the water from the geothermal wells.



Figure 1: External view of the analyzed enclosure

### 3. TECHNICAL ANALYZES

Taking into account the climatic characteristics during the winter of the area where the analyzed building is part, we obtain the following reference values [7]:

- outdoor calculation temperature ( $t_{e,c}$ ):  $-12\text{ }^{\circ}\text{C}$ ;
- the duration of the heating period ( $\tau_{i,c}$ ): about 180 days / year, considering an outside temperature of  $11\text{ }^{\circ}\text{C}$  from which the heater starts;
- number of degrees-days ( $N_d$ ): 3000.

For inside calculation temperature ( $t_{i,c}$ ) of  $20\text{ }^{\circ}\text{C}$ , average outdoor temperature over the heating period ( $t_{e,md}$ ), calculated with the formula (1) is of  $3.3\text{ }^{\circ}\text{C}$ .

$$t_{e,md} = t_{i,c} - N_d / \tau_{i,c} \quad (1)$$

Considering the underfloor heating solution using geothermal well water heat, this involves the existence of a surface heat exchanger that transmits heat from the geothermal fluid (primary fluid) to the water flowing through the interior of the coils (secondary fluid). The secondary fluid will pass the heat through the floor to the inside of the enclosure. Taking into account the temperature limitations given by floor heating, this solution provides minimum temperature differences between the primary and secondary fluid. The temperature of the secondary fluid at the exit of the heat exchanger was considered  $45\text{ }^{\circ}\text{C}$ . The heating system can be pre-dimensioned using both fluid flow equations and heat transfer equations [8]. Further are presented the values obtained from the calculations.

Considering that the average usable area for an apartment is about  $50\text{ m}^2$ , we have chosen two parallel heating circuits (sections), each with  $25\text{ m}^2$ . For a unit thermal flow transmitted by floor of  $100\text{ W/m}^2$ , the thermal power will be  $2500\text{ W}$  on each section and  $5000\text{ W}$  per apartment.

Choosing the inner diameter of the pipes ( $d_i$ ), of the secondary circuit, of  $0.016\text{ m}$  and the speed of water through them ( $v_w$ ) of  $0.5\text{ m/s}$  the flow of fluid through each section ( $\dot{m}$ ) is of

0.1 kg/s and water temperature difference in the secondary circuit ( $\Delta t$ ) of 6 °C. It was considered that the density of water, at the average pressure and temperature in the pipes, is 990 kg/m<sup>3</sup>. For  $d_i = 0.014$  m, results  $\dot{m} = 0.076$  kg/s and  $\Delta t = 7.8$  °C, if the same water flow rate is considered. For  $v_w = 0.6$  m/s temperature differences of 4.98 °C are obtained, respectively of 6.5 °C and water flows of 0.12 kg/s, respectively of 0.091 kg/s. Any of the previous variants can be selected, but taking into account that the optimal temperature difference is 5 °C, we choose the variant:  $d_i = 0.016$  m,  $v_w = 0.6$  m/s,  $\dot{m} = 0.12$  kg/s.

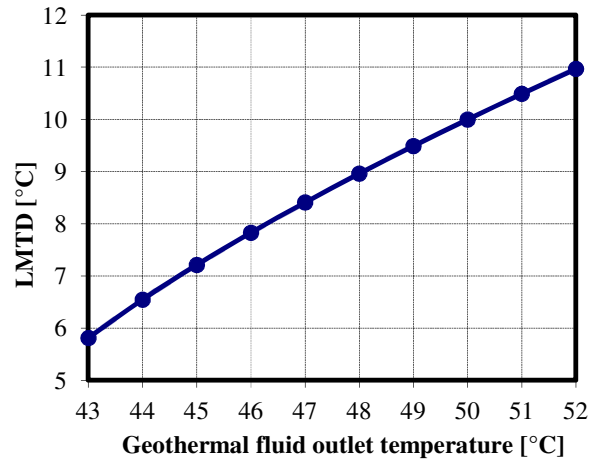

Figure 2: LMTD vs. geothermal fluid outlet temperature

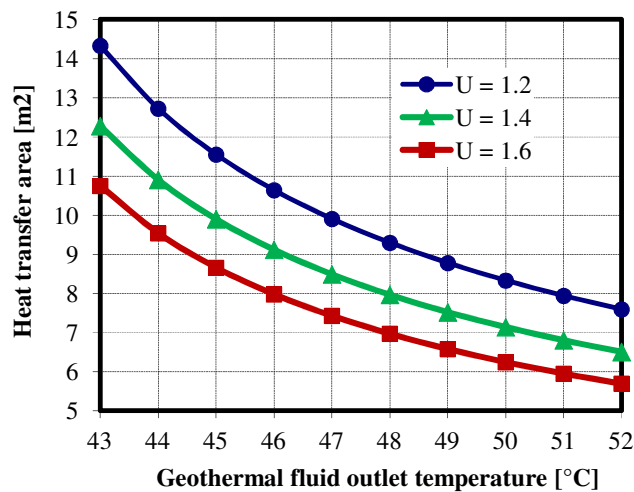

Figure 3: Heat transfer area vs. geothermal water outlet temperature

Therefore, the temperatures of flow and return of the secondary fluid will be 45 °C, respectively of about 40 °C. For the sizing of the heat exchanger, we will make calculations for a reference heating surface of 1000 m<sup>2</sup>, equivalent to 20 apartments. The total secondary fluid flow will be 4.8 kg / s in this case and the total thermal power required for heating the considered area will be about 100 kW. The Reynolds number of about 15000 indicates a turbulent flow regime inside the heat exchanger pipes.

The variation of the logarithmic mean temperature difference (LMTD) with the geothermal fluid outlet temperature has been showed in the Figure 2.

Considering the heat exchanger overall heat transfer coefficient ( $U$ ) between 1.2 and 1.4 kW/m<sup>2</sup>/K, the total heat transfer area has been computed depending on the geothermal fluid outlet temperature from the heat exchanger and  $U$  (Figure 3).

#### 4. CONCLUSIONS

In the paper there were presented several possible options of heating a hotel ranked as a historic building, using the area's low-temperature geothermal potential. The building analyzed in the case study is part of the Imperial center of Herculane Baths.

According to the calculations both the floor heating system and heat exchange surface required to take heat from the geothermal fluid, were dimensioned. It has been observed that for the heating of 20 rooms, the size of this area varies between 5 și 15 m<sup>2</sup>, depending on the choice of the geothermal fluid temperature at the heat exchanger (between 43 °C and 52 °C) and the global exchange coefficient (between 1.2 and 1.4 kW /m<sup>2</sup>/K).

#### Acknowledgements

This work has been funded by University Politehnica of Bucharest, through the “Excellence Research Grants” Program, UPB – GEX 2017. Identifier: UPB- GEX2017, Ctr. No. 106 /2017 (EFIHIST).

#### References

- [1] Tuțică D., Cenușă V.E., Alexe, F.N., Darie G., *Increasing energy efficiency and thermal comfort in historical buildings – Case study for Romania*, 17th International Multidisciplinary Scientific GeoConference SGEM 2017, Albena, 29 June - 5 July, 2017, Vol. 17, Issue 42, pp 345-352.
- [2] Tudor, P., Tuțică, D., Ionescu, S.C., Cenușă, V.E., Grigore, M.C., *Thermal comfort assurance in historical buildings study case for touring facility*, 17th International Multidisciplinary Scientific GeoConference SGEM 2017, Vienna, 27 - 29 November, 2017, Vol. 17, Issue 63, pp 717-724.
- [3] Ionescu, C., Baracu, T., Vlad, G. E., Necula, H., Badea, A., *The historical evolution of the energy efficient buildings*, Renewable and Sustainable Energy Reviews, Vol. 49, pp 243-253, 2015.
- [4] Minciuc, E., Pătrașcu, R., Diaconescu, I., Tanasiev, V., *Energy Management for Local Communities, Quality - Access to Success*, Vol. 17, Issue 155, pp. 106-110, Dec. 2016.
- [5] Yilmaz, C. *Thermodynamic and economic investigation of geothermal powered absorption cooling system for buildings*. Geothermics, Vol. 70, pp. 239-248, 2017.
- [6] Norișor, M., Bădicu, A., Minciuc, E., Necula, H. *Increasing the operational efficiency of a heat engine plant through implementation of trigeneration*. 2017 International Conference on ENERGY and ENVIRONMENT (CIEM), pp. 520-523, IEEE, 19-20 Oct. 2017.
- [7] Athanasovici, V. et al., *Treaty of thermal engineering. Heat supply. Cogeneration (Tratat de inginerie termică. Alimentări cu căldură. Cogenerare)*, AGIR, Bucharest, 2010.
- [8] Ilina, M. et al., *Installation manual, Warming systems (Manualul de instalații, Instalații de încălzire)*, Vol. 1, ARTECNO, Bucharest, 2002.

# INCREASING THE EFFICIENCY OF THERMAL COLLECTORS BY USING THERMAL TUBES

Krisztina Uzuneanu  
“Dunarea de Jos” University of Galati, Faculty of Engineering  
47 Domneasca St., Galati, Romania  
kuzuneanu@ugal.ro

## ABSTRACT

To achieve a maximum efficiency of solar energy collection, thermal tubes are used associated with a highly effective alternative, namely the inclusion of thermal tube inside the vacuum tubes which minimize the energy losses in the external environment. Thus the most effective solar power devices are achieved. Using thermal tubes in the solar panels is a very effective solution due to their obvious advantages in terms of heat transfer with the highest density of the heat flow. The paper presents thermodynamic analysis of the processes in thermal tubes for solar collectors.

## 1. INTRODUCTION

Many benefits of renewable energy are known: they contribute to combat climate change, they are a secure supply of energy and serve economic interest for a long time. Solar energy is the most important form of renewable energy. Solar radiation can be converted into electricity or into heat by solar collectors. These ones can be non-concentrating or concentrating and they can be stationary or tracking the sun.

Flat plate collectors deliver energy at low temperatures and for some applications it is necessary to deliver energy at higher temperatures. This is possible by interposing an optical device between the source of radiation and absorber, to raise the level of incidence radiation on the relatively small absorber. The efficiency of solar collector depends on many factors: design, construction, position, orientation, climatic condition of the place, application for they are used.

The sun's position during one day and the collector orientation highly influence the performance of the collectors. The best solution to collect solar radiation for a long time during the light day is to use tracking systems to follow the sun. However this solution is not preferred because of the cost of these systems and the supplementary needs for maintenance.

## 2. THERMAL MODELING OF A THERMAL TUBE

Thermal modeling of a gravity heat tube is generated by applying a simple electrical analogy. Total heat flow is proportional to the temperature difference between the evaporation area  $T_e$  and the condensation area  $T_c$  and is inversely proportional to the equivalent thermal resistance between the two areas. By analogy with Ohm's law it can be written [19], [20]:

$$\dot{Q} = \frac{T_e - T_c}{R_t} \quad (1)$$

The equivalent thermal resistance between the hot source (where vaporization takes place) and the cold one (where vapors condense) is given by the relation:

$$R_t = R_1 + R_2 + R_3 + R_4 + R_5 + R_6 + R_7 + R_8 \quad (2)$$



The thermal model is given in the figure below [21], [19]:

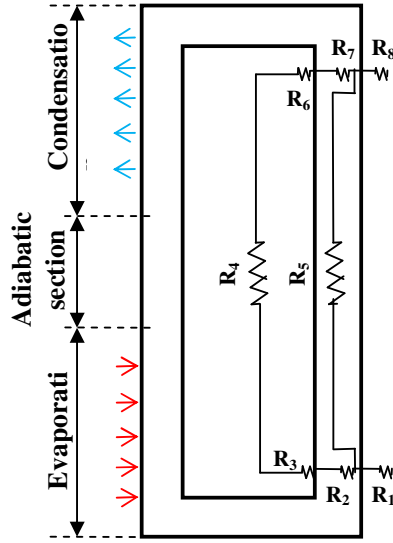

Figure 1: Thermal model of the conventional thermal tube

Thermal resistances are given by the following relations:

- Thermal resistance between the heat source and the external surface of the evaporator

$$R_1 = \frac{1}{h_{ee}A_{ee}} \quad (3)$$

where:

$A_{ee}$  - external surface area of the vaporization zone [m<sup>2</sup>];  
 $h_{ee}$  - heat exchange coefficient by convection [W/m<sup>2</sup>K].

- Thermal resistance in the evaporator wall:

$$R_2 = \frac{\ln \frac{D_e}{D_i}}{2\pi L_e k} \quad (4)$$

where:

$D_e, D_i$  – outer and inner diameter of the wall [m];  
 $L_e$  – length of the vaporization zone [m];  
 $k$  – thermal conductivity [W/mK].

- Inner thermal resistance of the fluid at the boiling point:

$$R_3 = \frac{1}{h_{ei}A_{ei}} \quad (5)$$

where:

$A_{ei}$  – internal surface area of the vaporization zone [m<sup>2</sup>];  
 $h_{ei}$  - heat exchange coefficient by convection [W/m<sup>2</sup>K].

- Thermal resistance due to vapor pressure drop between the vapor and condensation zones. This resistance is the ratio of temperature drop between the evaporator and condenser and the heat flow:

$$R_4 = \frac{T_{sat}}{Q} \quad (6)$$

- Thermal resistance along the thermal tube:

$$R_5 = \frac{0.5 L_e + L_a + 0.5 L_c}{Ak} \quad (7)$$

where:

$L_e, L_a, L_c$  – length of the vaporization adiabatic and condensing zone [m]

- Internal thermal resistance of the condensed fluid :

$$R_6 = \frac{1}{h_{ci}A_{ci}} \quad (8)$$

where:

$A_{ci}$  - internal surface area of the condensing zone [m<sup>2</sup>];

$h_{ci}$ - heat exchange coefficient by convection [W/m<sup>2</sup>K].

- Thermal resistance in the condenser wall:

$$R_7 = \frac{\ln \frac{D_e}{D_i}}{2\pi L_c k} \quad (9)$$

where:

$D_e, D_i$  – outer and inner diameter of the wall [m];

$L_c$  – length of the condensing zone [m];

- Thermal resistance on the external surface of the condenser:

$$R_8 = \frac{1}{h_{ee}A_{ee}} \quad (10)$$

where:

$A_{ce}$  - external surface area of the condensing zone [m<sup>2</sup>];

$h_{ce}$  - heat exchange coefficient by convection [W/m<sup>2</sup>K].

### 3. ADVANTAGES OF USING HEAT - PIPE SOLAR PANELS

Using thermal tubes/heat pipes in the solar panels is a very effective solution due to their obvious advantages in terms of heat transfer with the highest density of the heat flow.

To achieve a maximum efficiency of solar energy collection, heat pipes are used associated with a highly effective alternative, namely the inclusion of heat pipe inside the vacuum tubes which minimize the energy losses in the external environment. This is the most effective solar power devices are achieved.

The vacuum tubes capture and convert solar radiation into heat, warming the lower end of the heat pipes acting as vaporizer for the heat agent within it. Heat is then transported to the top of the heat tube by the vapors in the evaporator and it is subsequently sent to the fluid outside the tube by condensing the vapors (Fig.2.).

The heated fluid, which is usually propylene glycol resistant to frost, is circulated in closed circuit by a pump flow between solar collector where it picks up the heat and the storage tank, where it gives the heat off.

From this storage tank heat is transmitted to the hot water circuit for the final users.

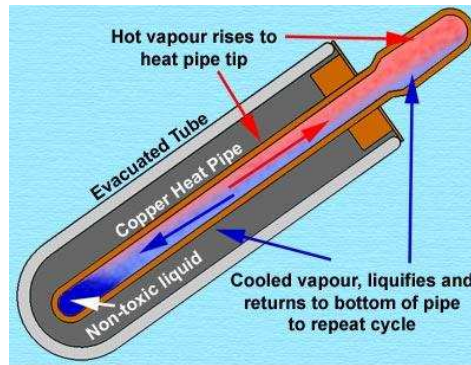

Figure 2: Vacuum tube and heat tube collector

#### 4. CONCLUSIONS

Thermal tubes have advantages, such as:

They work regardless of outside temperature, even in winter;

Vacuum tubes provide good performance during cloudy days, being able to capture infrared rays penetrating the clouds;

A heat- pipe solar collector can be up to 40% more efficient than traditional flat solar heater;

Heat pipe solar collectors remove the need for antifreeze additives due to the very good insulation provided by the vacuum and can work up to at least  $-300\text{ C}$ ;

The panel still works even if one or more tubes are broken;

Damaged tubes are easy to change;

Provide energy efficiency all year round and provides zero-cost with conventional fuels for at least 5 months per year;

The energy provided by the panels is clean/ecologic energy and do not pollute the environment;

They feature the best quality - price ratio on the market.

#### References

- [1] H. Moghadam, et al., „*Optimization of solar flat collector inclination*”, Desalination, 2010.
- [2] Adnan Shariah, M-Ali Al-Akhras, I.A. Al-Omari , „*Optimizing the tilt angle of solar collectors*” , Renewable Energy 26, 2002.
- [3] Kamal Skeiker, „*Optimum tilt angle and orientation for solar collectors in Syria*”, Energy Conversion and Management 50, 2009.
- [4] Huseyin Gunerhan, Arif Hepbasli, „*Determination of the optimum tilt angle of solar collectors for building applications*” , Building and Environment 42, 2007.
- [5] Hamdy K. Elminir, Ahmed E. Ghitas, F. El-Hussainy, R. Hamid, M.M. Beheary, Khaled M. Abdel-Moneim, „*Optimum solar flat-plate collector slope: Case study for Helwan, Egypt*”, Energy Conversion and Management 47, 2006.
- [6] Mohd Azmi bin Hj Mohd Yakup , A.Q. Malik, „*Optimum tilt angle and orientation for solar collector in Brunei Darussalam*”, Renewable Energy 24, 2001.
- [7] Runsheng Tang, Maogang Wu, Yamei Yu, Ming Li, „*Optical performance of fixed east–west aligned CPCs used in China*”, Renewable Energy 35, 2010.
- [8] J.M. Pinazo, J. Canada, F. Arago, „*Analysis of the Incidence Angle of the Beam Radiation on CPC*”, Solar Energy 49, 1992.
- [9] Boletim Actinometrico de Portugal, Instituto Nacional de Meteorologia e Geofisica, ISSN 0870– 4740, 1989.
- [10] Robert E. Parkin „*Solar angles revisited using a general vector approach*”, Solar Energy 84, 2010.
- [11] J.A. Duffie, W. A. Beckman „*Solar Engineering of Thermal Processes*”, 1980.

# ENERGY FROM BIOMASS OBTAINING IN THE GASIFICATION PROCESS – MODULAR CONSTRUCTION OF THE GASIFICATION MACHINE

Grzegorz Wieczorkiewicz<sup>1</sup>, Krzysztof Jesionek<sup>2</sup>, Michał Rychlik<sup>3</sup>, Robert Roszak<sup>3</sup>

<sup>1</sup>CAD-MECH Company Ltd, Poland, <sup>2</sup>Faculty of Technical and Engineering Wrocław University of Science and Technology, Poland, <sup>3</sup> Department of Virtual Engineering Poznan University of Technology, Poland

**Abstract-** The paper presents an innovative solution of modern equipment for gasification of biomass and production of electric power. Motivation to develop this installation were European Union directives related to waste management and supporting activities for reducing problems related to the "low emission". Demonstration installation called "EKOMPAKT" was performed as part of the project Demonstrator + under the title "Developing and testing on a demonstration scale an innovative, compact module for the production of power from biomass".

The article presents the process of gasification used in the project and describes the concept and operation scheme of the device. Furthermore the machine was started and the selected parameters and the results of the tests were presented and discussed in the work.

**Keywords-** Biomass, Economic efficiency, Gasification process, Light mobility installation

## 1. INTRODUCTION

The researches for alternative energy sources have been studied in the world for many years. Nowadays, works has been carried out with particular emphasis on obtaining energy from waste and biomass. As a result, many technical solutions for conducting the process of biomass gasification were created. Usually, most of the professional devices are large stationary installations, capable of processing large amounts of biomass, acting alone or in cogeneration with systems based on fossil fuels.

Such systems, have usually status of "ECO" (acronym: ecology), but are ecologically only from theoretical point of view, because they are based on the processing of biomass supplied to the gasification site with systems based on fossil fuels. In addition, the rising costs of extraction and transport of fossil fuels result in increasingly inexpensive waste processing and simultaneously minimizing environmental waste production.

The paper presents an innovative solution of modern equipment for gasification of biomass and production of electric power. Motivation to develop this installation were European Union directives related to waste management and supporting activities for reducing problems related to the "low emission". Demonstration installation called "EKOMPAKT" was performed as part of the project Demonstrator + under the title "Developing and testing on a demonstration scale an innovative, compact module for the production of power from biomass".

Additionally strong motivation element to develop a demonstration plant for gasification of biomass is a noticeable and increasingly prominent issue in the European Union's structures related to waste management, renewable energy supporting the development of distributed sources of electricity (including renewable energy sources) and supporting activities significantly reducing problems related to the so- "Low emission". Consequently,

---

<sup>1</sup> CAD-MECH Company Ltd, Poland, tel.: +48 71 797 52 83, e-mail: grzegorz.wieczorkiewicz@cadmech.pl

the objectives of the project have adopted the main assumptions for the current local and strategic needs of the directions set out in the EU directives. These directives are: Directive 2008/50 / EC on air quality and cleaner air for Europe; Directive 2008/98 / EC on waste and repealing certain directives; Directive 2009/28 / EC on the promotion of the use of energy from renewable sources;

- Utilization of waste at their place of origin and hence a significant reduction of waste disposal costs by reducing the need for waste transport to waste treatment plants and thereby significantly reducing "low emissions" (particles smaller than 10 $\mu$ m)
- Consumption of energy (heat and electricity) produced from biomass at the place of its production and hence reduction of costs of purchasing power from the central power grid, reduction of transmission charges, reduction of CO<sub>2</sub> emissions, additional revenue from the sale of electricity and heat,
- The consumption of heat in the immediate vicinity of its production by inserting it into the local heating network, or by direct supplying, for example, utilities, significantly affects the local reduction of "low emissions"
- The possibility of connecting the system to the main power energy grid and thus obtaining additional revenue from the sale of generated electricity.

Demonstration installation was performed as part of the project Demonstrator + - "Developing and testing on a demonstration scale an innovative, compact module for the production of power from biomass" called "EKOMPAKT". Project co-financed by the European Union from the European Regional Development Fund, Project implemented in cooperation with the Faculty of Mechanical Engineering of the Wroclaw University of Technology. As part of the project, it is assumed that, on the basis of the experience gathered, it will be designed and tested in complete simulations and then built innovative, compact and mobile module for converting biomass (especially waste) into the power energy. In this context, it will be possible to completely recycle the heat generated, with the aim of eliminating the conversion of "waste into the waste" At the same time, it provides a great opportunity for individual modifications of the installation.

## **2. GASIFICATION PROCESS OF BIOMASS**

According to [1], [7] gasification is a process in which solid or liquid raw materials are converted into more useful and convenient gas fuel. The resulting gas is used to generate of power energy. Gasification, unlike combustion, involves the formation of chemical bonds in gaseous products to produce the power energy, while burning involves destroying these bonds to produce energy. The gasification process adds hydrogen and collects carbon from the raw material thus creating a gas with a higher hydrogen to carbon ratio.

Typical gasification processes include the parts:

- desiccation
- thermal decomposition or pyrolysis
- partial combustion gases, vapors and decolourizing coal
- gasification of products decay

Gasification requires a factor gasification to change the structure of the gas to be converted into gas or liquid The gasifying factor reacts with coal and hydrocoal to transform it into low molecular weight gases such as CO or H<sub>2</sub>, therefore the gasification factor is essential for gasification. Oxygen, steam and air are the most common. Oxygen is a very popular gasifier, although it is primarily used during the combustion stage. It can be applied to the gasifier in pure

form or in the form of air (confuse of oxygen and nitrogen). The three-component scheme (Fig. 1) present the pathways for the formation of different combustion products depending on the amount of hydrogen carbon and oxygen in the fuel and depending on the gasification factor used. If pure oxygen is used as the gasification agent, the conversion path is shifted towards the corner with oxygen (right bottom corner in Fig. 1). Then the combustion products contain CO for a small amount of oxygen and CO<sub>2</sub> for more oxygen. When the amount of oxygen exceeds a certain (stoichiometric) value, the process changes from gasification to combustion, and consequently gas is produced instead of gas. In this case, neither the combustion gases nor the combustion products have a significant calorific value when cooled. Providing more oxygen leads to a reduction in the amount of hydrogen and an increase in the amount of carbon compounds - ie CO and CO<sub>2</sub>, as the gasification product. If air is used instead of oxygen, the nitrogen atom significantly weakens the calorific value of gasification products. instead of oxygen, steam is used as the gasifying agent, then the gasification path in Fig. 1 will move to the hydrogen corner. Gasification products then contain more hydrogen per unit of carbon. Sometimes indirect reaction products (ie, CO, H<sub>2</sub>) also help in the coal gasification process [1],[2],[3],[7]

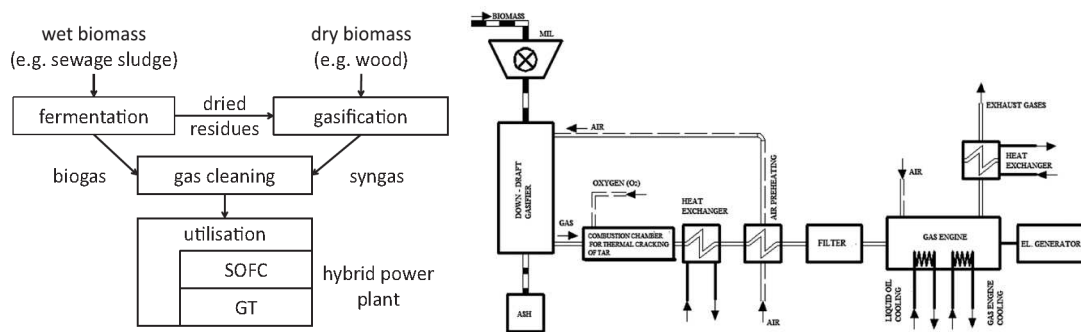

Figure 1. Scheme of the biomass conversion and power generation process [7] and principle scheme of biomass gasification plant [6]

The choice of the gasification factor is therefore of paramount importance in the gasification process because it represents the calorific value of the gas obtained after the process. The estimated gas calorific value of the gas depending on the gasification factor is given in Table 1 [1], [2].

Table 1. Calorific value of gaseous products depending on the gasification factor (Basu P., 2010) (Zhang W., 2010)

No	Gasification factor	Calorific value $\frac{MJ}{m^3}$
1	Air	4-7
2	Steam	10-18
3	Oxygen	12-28

The typical gasification process follows the steps below. The diagram of biomass gasification is shown in Figure 1. The basic process of gasification of biomass assumes preheating (drying of biomass) followed by thermal degradation or pyrolysis. Pyrolysis products (ie gas, solid and liquid) react with each other and with the gasification agent to form gasification products. In most gasification machines available in the industry, the heat energy required for drying biomass, pyrolysis and endothermic reactions is derived from the exothermic combustion reactions produced in the gasifier machines [4], [5], [6].

Typical installation of gasification includes a gas generator reactor and its auxiliary equipment, consisting of the parts:

- biomass handling system
- biomass feeding system
- gas cleaning system
- cinder and particulate removal system.

### 3. CONCEPT OF GASIFICATION MACHINE “EKOMPAKT”

The "EKOMPAKT" machine performed within the project Demonstrator+ is a device designed to process biomass in the amount of 300kg/h and consists of the following modules (Fig. 2):

- biomass preparation module: shredder and intermediate tank (I)
- reactor module (II)
- gas cleaning module: cyclones, catalyst (III)
- gas conditioning module (IV)
- generator module (V)

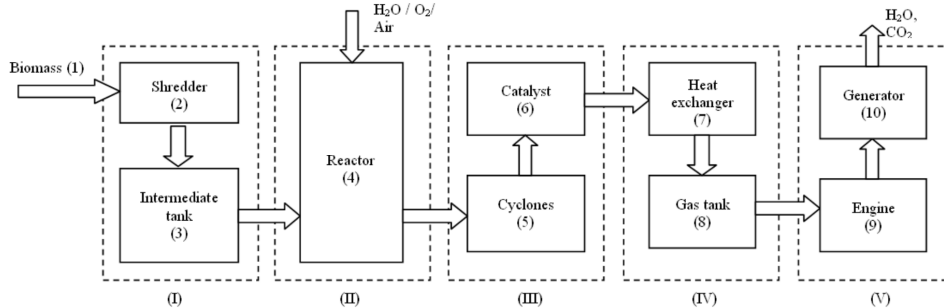

Figure 2. Idea of "EKOMPAKT" gasification machine - technological modules

Separate components of the installation are built in 20-foot containers, which allows easy expansion of the system by multiplication of individual modules. Demonstration installation allows verification and optimal selection of the gasification process for the given fuel type by means of the possibility of checking the gasification process downstream and upstream, and also with recovery and without recovery of heat from the exhaust. Demonstration installation allows to verify and optimum gasification process for a particular type of fuel by checking the simultaneous and counter-current gasification process as well as with recovery and without heat recovery from exhaust, and non-recovery. Such a real-time verification of the process gives great security to obtain and develop optimal gasification parameters for a given fuel and achieve optimum financial benefits from this process. Commercial installations that are currently in a very advanced design stage will also be equipped with a remote monitoring system. Information about the level of emissions can be made available to individual institutions and local governments, giving them the opportunity to apply for the "EKO" status, ie. environmentally friendly.

The feed material, oak wood blocks, comes from a Poland, The blocks are cut into an average size 3 cm3 cm3 cm by hand. Its density is 720 kg/m3,. Its ultimate and proximate analysis is presented in Table 2.

Table2. Proximate and ultimate analysis of oak wood blocks

Parameter	Value
Moisture content (wt% wet basis)	8
Higher heating value (kJ/kg)	20,540
Proximate analysis (wt% dry basis)	
Volatile matter	82
Fixed carbon	17.16
Ash	0.55
Ultimate analysis (wt% dry basis)	
C (carbon)	50.54
H (hydrogen)	7.08
O (oxygen)	41.11
N (nitrogen)	0.15
S (sulfur)	0.57

#### 4. SCHEME OF OPERATION

The biomass by transport system (1) is transported to the shredder (2), which processing the biomass to produce a material up to 3x3x3 cm in size (Fig. 2). This size of material allows for a smooth gasification process. From the shredder (2) the fuel is transported to the intermediate tank (3), where it is premixed to pre-homogenize the fuel, which also has a significant effect on the smooth gasification process. In this tank, the fuel can be pre-heated to increase the efficiency of the gasification process and additionally dried to obtain an optimum level of fuel humidity. From the tank (3) the fuel is transported to the reactor (4), where the gasification process occurs. Depending on the type of fuel, additional carrier gases H<sub>2</sub>O or O<sub>2</sub> or air are added to the reactor. Mineral compounds remaining after gasification are removed from the gasifier outside the installation. Syngas from the reactor (4), due to the possibility of contamination with solid particles, is transported to the cyclones system (5), where it is cleansed. From cyclones (5), the syngas is transported to a catalyst (6), which is used to interception of the particles that have not been trapped in cyclones and shorten the hydrocarbon chains to a level that will remain gas when the temperature of the syngas decreases. Syngas from cyclones (6) are transported to a heat exchanger (7) in which the gas is shocked cooled to prevent re-forming of long hydrocarbon chains that remain liquid or tar at ambient temperature. From the heat exchanger (7), the gas is transported to the set of tanks (8), in addition it is mixed, in order to homogenize its chemical composition, to ensure stable operation of the internal combustion engine (9). Internal combustion engine powered by Syngas drives the generator (10) that generates power electricity. The installation is described as a self-sufficient installation, which, when activated and powered by biomass, generates heat and power electricity for its own use and sale.



Figure 3. Real construction of gasification machine "EKOMPAKT"



The presented idea of operation was used in the final stage to build a real machine. On figure 3 the construction of the machine is presented. The energy efficiency of the "EKOMPAKT" machine is 1kW/1kg of biomass. The calorific value of gas obtained during tests from the gasification process was at the level of 11MJ/m<sup>3</sup>.

## 5. CONCLUSION

Demonstration gasification machine "EKOMPAKT", through to its container construction, is a mobile device and easily scalable. This is consistent with the development strategy defined by the European Union directive. It also responds to local and social needs related to waste reduction and low emission reduction. In addition, the gasification machine "EKOMPAKT" device reduces the cost of the enterprises involved in waste disposal and also reduces the costs associated with the purchase of energy. For local governments, as well as entrepreneurs, the "EKOMPAKT" installation is a demonstration of the policy of conducting business in an environmentally friendly way. Currently, the device works using oak wood as fuel for technical testing purposes. Further tests with other types of biomass (fuels) are in preparation.

## 6 ACKNOWLEDGEMENT

Project Co-financed by the European Union from the European Regional Development Fund GRANTS FOR INNOVATIONS - Demonstrator+ Program Project title: "Developing and testing on a demonstration scale an innovative, compact module for the production of power from biomass"

## 7. REFERENCES

- [1] Basu P. (2010). Biomass gasification and pyrolysis – practical design and theory. Book of Elsevier, Burlington, USA, 27-40
- [2] Zhang W. (2010). Automotive fuels from biomass via gasification. *Fuel Process Technol.* 2010;91(8):866–76.
- [3] Catallo WJ. & Shupe TF. & Eberhardt TL. (2008). Hydrothermal processing of biomass from invasive aquatic plants. *Biomass Bioenergy*, 32(2), 140–5
- [4] Sun Y-I. & Yoon SJ. & Kim YK. & Lee J-G. (2011). Gasification and power generation characteristics of woody biomass. *Biomass Bioenergy*, 35(10), 4215–20
- [5] Akhtar J. & Amin N. (2011). A review on process conditions for optimum bio-oil yield in hydrothermal liquefaction of biomass. *Renew Sust Energ Rev*, 15(3), 1615–24.
- [6] G. Janke\*, M. Trninić, M. Stamenić, T. Simonović, N. Tanasić, And J. Labus, Biomass Gasification With Chp Production, A Review of the State-of-the-Art Technology and Near Future Perspectives, *THERMAL SCIENCE*, 2012, Vol. 16, pp. S115-S130
- [7] T. Methling, N. Armbrust, T. Haitz, M. Speidel, N. Poboss, M. Braun-Unkhoff, H. Dieter, B. Kempter-Regel, G. Kraaij, U. Schliessmann, Y. Sterr, A. Wörner, T. Hirth, U. Riedel, G. Scheffknecht, Power generation based on biomass by combined fermentation and gasification – A new concept derived from experiments and modelling, *Bioresource Technology*, 2014; 169, pp 510-517.

# ANALYTICAL HEAT CONDUCTION SOLUTION FOR TWO-DIMENSIONAL CARTESIAN SLAB UNDER THE EFFECT OF A LASER PULSE

Wisam A. Abd Al-wahid<sup>1</sup>, Qahtan A Abed<sup>2</sup>

<sup>1,2</sup> Dr. Eng. Al-Furat Al-Awsat Technical University, Engineering Technical College- Najaf, Iraq.

## Abstract

The analytical solution of two-dimensional transient heat conduction in two slabs bounded to each other presented in this paper appears. They are exposed to the pulse of the laser beam. The heat transfer coefficients of the two slabs are supposed to change with direction. The separation of variables method is used in the sense it is easy and effective with these types of problems. The results showed an easy and elegant analytical solution. These results compared with the data obtained by the numerical solution of the same problem by using COMSOL Multiphysics 5.2. They showed a good agreement with the numerical solution, the behaviour of the heat propagation occurs over time in the field.

**Keywords:** conduction heat transfer, separation of variables, transient, directional conduction coefficient.

## 1- INTRODUCTION

A great attention given to study multi-layers combinations of different materials due to their wide applications in industry. Heat conduction takes greatest share of that attention for these combinations weather the materials were isotropic or anisotropic, steady or transient. Therefore, many kinds of analytical and numerical solutions appeared due to that attention. Focus on analytical solutions taken, since present work is in that field. One can find books dealing with kinds of analytical solutions for enormous cases [1 and 2]. However, accurate details in the application cases led to different kinds of solutions in literatures for each case. Weather solutions were steady [3, 4, and 5], or transient [6, 7, 8, 9, 10, 11, 12, and 13], Cartesian [3, 5, 7, 8, 10, and 13], cylindrical [4, 6, 11, and 12], or spherical coordinates [9], analytical solution changes according to nature of each case. Solution may be based on series [5, 9, and 13], transformation [3, 6, 7, 8, and 11], or by using separation of variables [3, 10, and 12]. However, it is appeared hear that analytical solutions need mathematical skills to conduct the complex solution of complex geometries or boundary and initial conditions. Nevertheless, still, these kinds of solutions are attractive due to their elegance and accuracy.

In present work, anisotropic, two-dimensional, Cartesian, two-layered slab taken under influence of a pulse of laser beam in center of that slab as shown in figure 1.

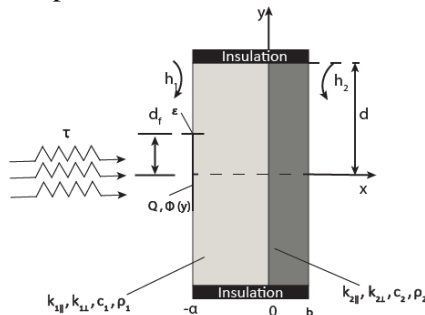

Figure 1. Problem of the present work.

<sup>2</sup> Corresponding author, email [qahtan77@yahoo.com](mailto:qahtan77@yahoo.com)

The solution conducted is analytical by the use of separation of variables, where the solution compared to numerical procedure to validate the solution.

## 2- MATHEMATICAL ANALYSIS

The problem solved analytically starting from basic equations of Fourier's equation of conduction heat transfer for two-dimensional Cartesian coordinates:

$$\frac{\partial}{\partial x} \left( k_{h1} \frac{\partial T_1}{\partial x} \right) + \frac{\partial}{\partial y} \left( k_v \frac{\partial T_1}{\partial y} \right) = \rho_1 C_{p1} \frac{\partial T_1}{\partial t} \quad (1)$$

$$\frac{\partial}{\partial x} \left( k_{h2} \frac{\partial T_2}{\partial x} \right) + \frac{\partial}{\partial y} \left( k_v \frac{\partial T_2}{\partial y} \right) = \rho_2 C_{p2} \frac{\partial T_2}{\partial t} \quad (2)$$

Where:  $k_h$  and  $k_v$  are directional heat conduction coefficient [W/ (m. K)].  $C_p$  is heat transfer capacity [J/kg. K].  $T$  is temperature [K].

Note that heat transfer coefficient anisotropic with direction. Boundary and initial conditions according to the problem are:

$$k_{h1} \frac{\partial T_1(-l, y, t)}{\partial x} = h_1 T_1(-l, y, t) \quad (3)$$

$$k_{h2} \frac{\partial T_2(b, y, t)}{\partial x} = h_2 T_2(b, y, t) \quad (4)$$

$$k_{h1} \frac{\partial T_1(0, y, t)}{\partial x} = k_{h2} \frac{\partial T_2(0, y, t)}{\partial x} \quad (5)$$

$$T_1(0, y, t) - T_2(0, y, t) = 2bk_{h1} \frac{\partial T_1(0, y, t)}{\partial x} \quad (6)$$

$$\frac{\partial T_1(x, 0, t)}{\partial y} = 0 \quad (7)$$

$$\frac{\partial T_2(x, 0, t)}{\partial y} = 0 \quad (8)$$

$$\frac{\partial T_1(x, d, t)}{\partial y} = 0 \quad (9)$$

$$\frac{\partial T_2(x, d, t)}{\partial y} = 0 \quad (10)$$

With initial conditions:

$$T_2(x, 0, t) = 0 \quad (11)$$

$$T_1(x, 0, t) = \begin{cases} \phi(y) = F & 0 \leq y \leq \varepsilon \\ 0 & \varepsilon \leq y \leq d \end{cases} \quad (12)$$

Where:  $h$  is heat convection coefficient  $\frac{W}{m^2.K}$ .  $F$  is pulse parameter.  $\varepsilon$  is thickness of laser beam  $m$ .

The above initial condition (12) assumes opaque slab and no penetration in deep layers of slab. In addition, initial condition is not continuous where a sharp change in formula at boundaries. For this reason, the formula changed by an equivalent Fourier series as shown below:

$$\phi(y) = F \left[ \frac{2\varepsilon}{d} + \frac{2}{\pi} \sum_{m=1}^{\infty} \frac{\sin(\frac{2m\varepsilon}{d})}{m} \cos(\frac{m\pi y}{d}) \right] \quad (13)$$

In order to solve differential equations (1) and (2), separation of variables proposed by following assumption:

$$T_1(x, y, t) = X_1(x) \cdot Y_1(y) \cdot \Gamma_1(t) \text{ and } T_2(x, y, t) = X_2(x) \cdot Y_2(y) \cdot \Gamma_2(t)$$

Substitution the above assumptions in the differential equations led to:

$$\alpha_1 \frac{x_1''}{x_1} + \frac{y_1''}{y_1} = \frac{1}{\alpha_{v1}} \frac{t_1'}{t_1} \quad (14)$$

$$\alpha_2 \frac{x_2''}{x_2} + \frac{y_2''}{y_2} = \frac{1}{\alpha_{v2}} \frac{t_2'}{t_2} \quad (15)$$

$$\text{Where: } \alpha_1 = \frac{k_{h1}}{k_{v1}}, \alpha_2 = \frac{k_{h2}}{k_{v2}}, \alpha_{v1} = \frac{k_{v1}}{\rho_1 c_{v1}} \text{ and } \alpha_{v2} = \frac{k_{v2}}{\rho_2 c_{v2}}$$

In order to solve differential equations (14 and 15), Eigen parameters introduced to help in solution, which leads to the following sub-differential equations:

$$\alpha_{v1} \frac{\Gamma_1'}{\Gamma_1} = -\beta^2 \quad (16)$$

$$\alpha_{v2} \frac{\Gamma_2'}{\Gamma_2} = -\beta^2 \quad (17)$$

$$\frac{x_1''}{x_1} = \gamma^2 \quad (18)$$

$$\frac{x_2''}{x_2} = -\gamma^2 \quad (19)$$

$$\frac{y_1''}{y_1} = -\lambda^2 \quad (20)$$

$$\frac{y_2''}{y_2} = \eta^2 \quad (21)$$

$$\text{Where: } -\lambda^2 = \frac{-\beta^2}{\alpha_{v1}} + \alpha_1 \gamma^2 \text{ and } -\eta^2 = \frac{-\beta^2}{\alpha_{v2}} + \alpha_2 \gamma^2$$

The solutions of differential equations (16-21) are:

$$\Gamma_1 = C_1 e^{-\frac{\beta^2}{\alpha_{v1}} t} \quad (22)$$

$$\Gamma_2 = C_2 e^{-\frac{\beta^2}{\alpha_{v2}} t} \quad (23)$$

$$X_1 = C_3 \sin(\gamma x) + C_4 \cos(\gamma x) \quad (24)$$

$$X_2 = C_5 \sin(\gamma x) + C_6 \cos(\gamma x) \quad (25)$$

$$Y_1 = C_7 \sin(\lambda y) + C_8 \cos(\lambda y) \quad (26)$$

$$Y_2 = C_9 \sin(\eta y) + C_{10} \cos(\eta y) \quad (27)$$

Substitution of boundary conditions (7-10) in equations (26 and 27) lead to:

$$Y_1 = \sum_{n=0}^{\infty} C_{8n} \sin(\lambda_n y) \quad (28)$$

$$Y_2 = \sum_{n=0}^{\infty} C_{9n} \sin(\eta_n y) \quad (29)$$

$$\text{Where Eigen values: } \lambda_n = \frac{(2n+1)\pi}{2} \text{ and } \eta_n = \frac{(2n+1)\pi}{2}$$

Substitution of boundary conditions (3-6) in differential equations (24 and 25) lead to:

$$X_1 = C_4 [b_1 \sin(\gamma x) + \cos(\gamma x)] \quad (30)$$

$$X_2 = C_5 [\sin(\gamma x) + b_2 \cos(\gamma x)] \quad (31)$$

$$\text{Where: } b_1 = \frac{h_1 \cos(\gamma l) + k_{h1} \gamma \sin(\gamma l)}{h_1 \sin(\gamma l) + k_{h1} \gamma \cos(\gamma l)} \text{ and } b_2 = \frac{\gamma \cos(\gamma b) + \frac{h_2}{k_{h1}} \sin(\gamma b)}{\gamma \sin(\gamma b) - \frac{h_2}{k_{h1}} \cos(\gamma b)}$$

Application of boundary conditions (3 and 4), lead to:

$$C_4 = \frac{2b b_1 a_1 \gamma^{k_{h1}}}{D_2 - a_1} \quad (32)$$

$$C_5 = \frac{2bb_1r^k h_1}{b_2 - a_1} \quad (33)$$

The final solution became:

$$T_1(x, y, t) = \sum_{n=1}^{n=\infty} C_{11n} \sin(\lambda_n y) (b_1 \sin(\gamma_n x) + \cos(\gamma_n x)) e^{-\frac{g^2}{\alpha_{v1}} t} \quad (34)$$

$$T_2(x, y, t) = \sum_{n=1}^{n=\infty} C_{12n} \sin(\lambda_n y) (\sin(\gamma_n x) + b_2 \cos(\gamma_n x)) e^{-\frac{g^2}{\alpha_{v2}} t} \quad (35)$$

Where:  $C_{11n} = C_1 C_{3n} C_{4n}$  and  $C_{12n} = C_2 C_{5n} C_{9n}$

Substitution of initial condition (12) in equation (24) as well as using orthogonally:

$$C_{11n} = \frac{\int_{-l}^0 \int_0^d \phi(y) \sin(\lambda_n y) (b_1 \sin(\gamma_n x) + \cos(\gamma_n x)) dy dx}{\int_{-l}^0 \int_0^d \sin^2(\lambda_n y) (b_1 \sin(\gamma_n x) + \cos(\gamma_n x))^2 dy dx} \quad (36)$$

The solution of above double integration is:

$$C_{11n} = \frac{b_1 (\cos(\gamma_n l) + \frac{1}{b_1} \sin(\gamma_n l) - 1)}{\gamma_n d \lambda_n (C_{13n} + C_{14n} \sin(\gamma_n l) + \cos(\gamma_n l))} [2\lambda_n \cos(\lambda_n d)] \left[ \frac{F\epsilon}{d\lambda_n^2} (\sec(\lambda_n d) - 1) + \frac{P_1(1 + \sec(\lambda_n d))}{d - \lambda_n^2} + \frac{P_2(\sec(\lambda_n d) - 1)}{\frac{4\pi^2}{d^2} - \lambda_n^2} + \frac{P_3(1 + \sec(\lambda_n d))}{\frac{9\pi^2}{d^2} - \lambda_n^2} \right] \quad (37)$$

Where:  $C_{13n} = b_1 - \frac{l\gamma_n}{2}(b_1^2 + 1)$ ,  $C_{14} = 1 - \frac{b_1^2}{2}$ ,  $P_1 = \frac{2F}{\pi} \sin(\frac{\pi\epsilon}{d})$ ,  $P_2 = \frac{F}{\pi} \sin(\frac{2\pi\epsilon}{d})$  and  $P_3 = \frac{2F}{3\pi} \sin(\frac{3\pi\epsilon}{d})$

The same principle of orthogonally lead to:

$$C_{12n} = \frac{C_{11n}(1 - b_1 \gamma_n)}{b_2} \quad (38)$$

### 3- NUMERICAL SOLUTION:

In order to validate analytical solution, problem solved numerically using COMSOL Multiphysics 5.2 program. A transient solution of heat transfer in solids used. An extra fine mesh for element size chosen with Physics- controlled mesh as shown below.

Time interval for transient solution is 0.01 sec. Conduction heat transfer coefficient taken constant with direction, for simplicity of the solution. The left slab taken to be Aluminum while the other is Copper. Heat transfer parameters assumed constant. Pulse of heat input to medium taken to be 30kW of heat as initial condition of the problem. Table 1 below shows comparison of numerical solution with that found numerically. Data taken for a point in the middle of domain of  $x=0$ , and  $y=0.5$ , for periods of time after applying initial condition.

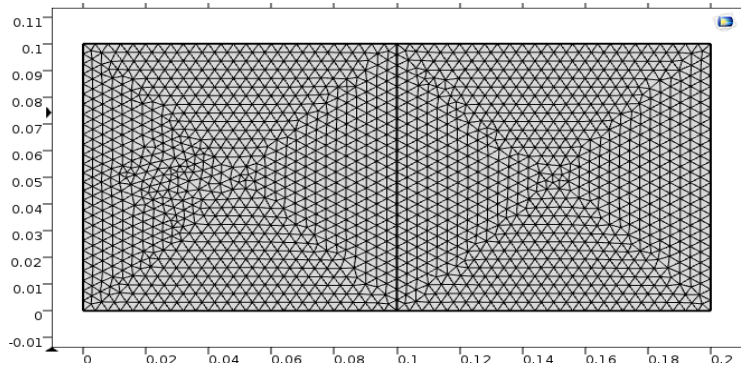

Figure 2. Mesh of numerical solution.

Table 1. Comparison of numerical solution with that found numerically

time	Numerical solution	Analytical solution
0	293.15	293.15
30	293.16	293.158
60	293.17	293.169
90	293.17	293.169
120	293.17	293.169

The data show a slight increase in temperature, and a settling after 30 seconds. The most important thing is closeness of numerical and analytical solutions.

#### 4- RESULTS AND DISCUSSIONS:

A good agreement of analytical solution with that of numerical suggest showing more transient results of domains of solution. Figures 3 show transient temperature distribution with a time interval of 15 seconds. Heat spread in as half circular shape within first interval, then isothermal lines starts to progress in a shape of parallel line due to insulation of top and bottom boundaries. After a minute and a half, first domain show to reach a uniform temperature distribution, while the second domain still suffering from heat progress in parallel isotherms. Whole process does not go out of common sense about the behavior of temperature progress, where results are only shown to expand the base of data presented. Solution may have extended, in future work, for a multiple laser pulses, or to use materials have some temperature dependent heat transfer coefficients.

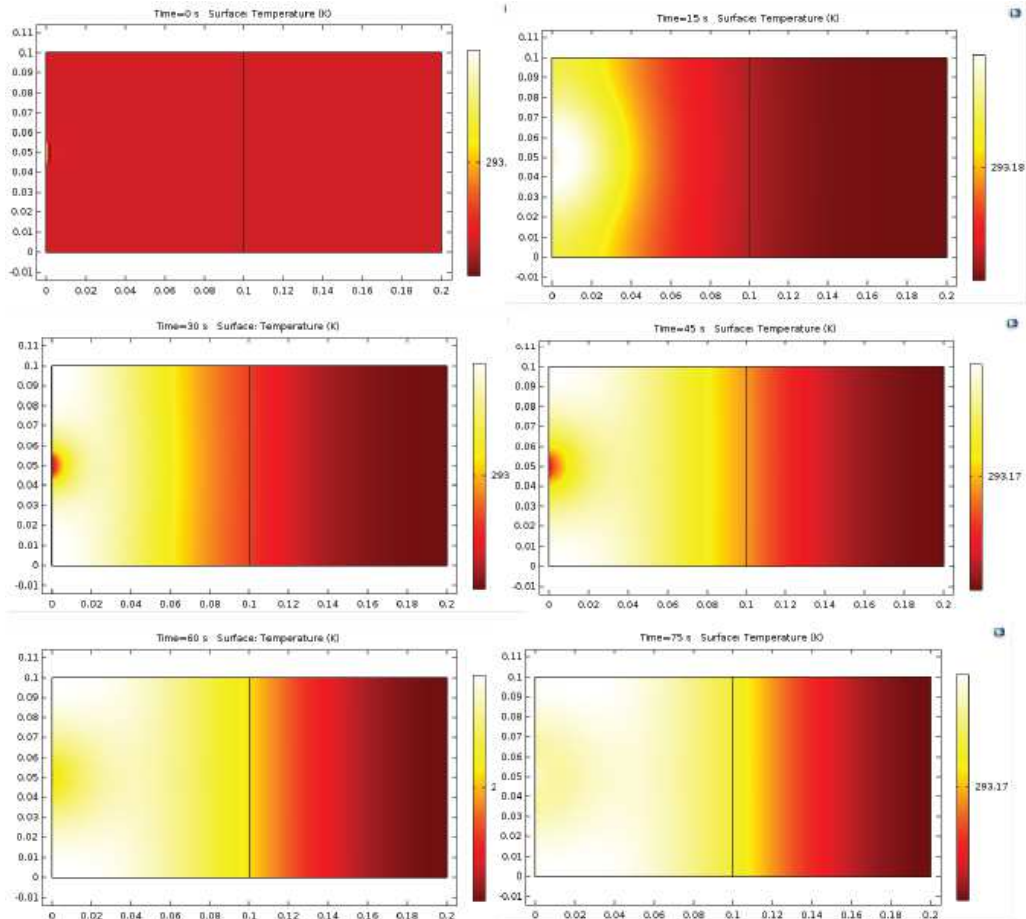

Figure 3. Transient temperature distribution for two domains of problem.

## Conclusion:

In present work, two slabs connecting vertically and one of them subjected to laser beam pulse. Heat transfer coefficient of conduction for both slabs changing with direction. The problem assumed to be time dependent in order to study heat conduction transfer. Separation of variables shown to be efficient method to solve such problems. It found that to be easy to have an analytical solution based on separation of variables and Fourier series to simulate the laser pulse on the side of the slab and overcome discontinuity of the pulse. As it known, heat diffusion depends on conduction heat transfer coefficient to shape the spread of heat.

## References:

- 1- Arpaci, Vedat S., "*Conduction heat transfer*", Addison-Wesley publishing company, 1966.
- 2- Sen, Mihir, "Analytical heat transfer", University of Notre Dame, 2015.
- 3- Moitsheki, Raseelo J., and Rowjee, Atish, "*Steady heat transfer through a two-dimensional rectangular straight fin*", Mathematical problems in engineering volume, 2011.
- 4- Floris, Francesco, et al. , "*A multi-dimensional heat conduction analysis: analytical versus F.E. methods in simple and complex geometries with experimental results comparison*", Energy Procedia, vol.81, pp. 1055-1068, 2015.
- 5- Ramos, C. Avides, et. al. , "*Exact solution of heat conduction in composite materials and applications to inverse problems*", Transactions of the ASME, vol. 120, August, 1998.
- 6- Abdul Azeez, M. F., and Vakakis, A. F. , "*Axisymmetric transient solutions of the heat diffusion problem in layered composite media*", International journal of heat and mass transfer, vol. 43, pp. 3883-3895, 2000.
- 7- Cole , K. D., and McGahan, W. A., "*Theory of multilayers heated by laser absorption*", Journal of heat transfer, ASME, 1993.
- 8- Buikis, A., et. al. , "*Analytical two-dimensional solutions for heat transfer in a system with rectangular fin*", Heat transfer VIII, B. Suden, 2004.
- 9- Jain, Prashant K., et. al. , " *An exact analytical solution for two-dimensional, unsteady, multilayer heat condition in spherical coordinates*", International journal of heat and mass transfer, vol. 53, pp. 2133-2142, 2010.
- 10- Mikhailov, M. D., and Ozisik, M. N., "*Transient conduction in a three-dimensional composite slab*", Int. j. Heat Mass Transfer, vol. 29, pp. 340-342, 1986.
- 11- Watt, D. A., "*Theory of thermal diffusivity by pulse technique*", Brit. J. Appl. Phys., vol.17, 1966.
- 12- Milosevic, N. D., and Raynaud, M., "*Analytical solution of transient heat conduction in a two-layer anisotropic cylindrical slab excited superficially by a short laser pulse*", International journal of heat and mass transfer, vol. 47, pp. 1627-1641, 2004.
- 13- Mahmoudi, Seyed Reza, and Toljic, Nikola, "*Exact solution of two-dimensional hyperbolic heat conduction equation with combined boundary conditions and arbitrary initial condition*", Proceeding of the ASME, Heat transfer summer conference, 2009.

# PROVIDING THE ISOLATED LOCALITIES WITH VARIOUS ENERGY TYPES AT THE ACCEPTABLE COST

Ultuar Zhalmagambetova<sup>1</sup>, Almagul Mergalimova<sup>2</sup>, Birlesbek Aliyarov<sup>3</sup>

Almaty University of Power Engineering and Telecommunications  
Heat power engineering faculty, Republic of Kazakhstan, Almaty.

## ABSTRACT

The features of the power supply for the remote isolated settlements with the different types of the energy and territorial and climatic features consideration are reviewed in this article.

A suggested technology is adapted to the conditions of a locality and working on the solid fuel. At the same time, the cost of the electricity, heat and gaseous fuels for the cooking will be more acceptable for a family with the middle and small income.

The proposed technology is based on the extraction of gaseous, so-called combustible volatile, with an acceptable heat of the combustion (from coal and wood). The presence of the gaseous fuel makes it possible to transfer cooking for the fuel supply from a single source. The resulting gaseous fuel also makes it possible to obtain electrical energy by the using gas turbines of a special design. Residual heat is directed to the combustion chamber to produce heat energy.

## 1. INTRODUCTION

The problem of the reliable and high-quality power supply to sparsely populated and remote settlements was acute in social, technical and economic aspects for the many countries. There are numerous remote villages in Kazakhstan and Russia that do not have access to a common supply system for the various types of the energy. Parts of the territories are characterized by the cold climatic conditions and a long heating period. The construction of the systems to provide by the various types of the energy in remote settlements is complicated by the high costs, and the difficult of the delivery of the goods, including the fuel, especially liquid, is not always cost-effective [1]. For example, providing a remote group of the buildings (housing of shepherd, mine settlements and others) with the electricity from the centralized sources, where the losses in the networks (especially the relative losses, that are directly related to the amount of the transported energy) were very high. [2]

The shortage of the energy and its high cost limit the possibilities of the providing a comfortable living and restrain economic growth in such regions. [3]

In the world practice there is a successful experience of increasing energy efficiency and the development of renewable energy sources. After all, increasing the efficiency of the electricity supply to isolated consumers is made through the use of the renewable energy sources (RES). But with such methods it is necessary to take into account the climatic conditions and the economic feasibility of applying RES.

---

<sup>1</sup> PhD Student, AUPET, Republic of Kazakhstan, e-mail [ultuara@mail.ru](mailto:ultuara@mail.ru), +7 777 340 11 31

<sup>2</sup> PhD Student, AUPET

<sup>3</sup> Professor Dr.Sc., AUPET



At the present time, in Kazakhstan, the supply of the various types of the energy to remote the isolated settlements is often carried out in a traditional way. In particular: the supply of heat energy and cooking is produced from individual solid fuel furnaces with the increased financial and labor costs (fuel preparation for the whole season, preparation of the fuel for the combustion, etc.), electric power is supplied by individual sources of the liquid fuel with a high cost).

## 2. METHODOLOGY

There are various proposals on the market to provide of the remote settlements with the different types of the energy. The one is independent generating sets that are: gasoline, diesel or gas power plants. And in spite of the fact that in the greater territory of the country, it is economically more expedient to use of the coal as the main fuel.

An alternative to the above methods of providing remote of the objects with the all types of the energy may be a new technology that is adapted to the conditions of a particular village, operating on solid fuel. This technology provides:

- supply by the heat energy for the heating and hot water needs;
- supply by the gaseous fuel for the cooking;
- supply by the electrical energy.

It is known that it is possible to obtain gaseous fuel from solid fuel. This extraction of the gaseous, so-called combustible volatiles, with an acceptable heat of the combustion (from coal and wood). The presence of the gaseous fuel makes it possible to transfer for the cooking the fuel supply from a single source (for this village). The resulting gaseous fuel also makes it possible to obtain of the electrical energy by the using gas turbines of a special design (with the reduced wear of the blades).

The proposed technology can be demonstrated in this way. In the village (if there is enough solid fuel in sufficient quantity), a volatile substance generator (from the coal or wood (pre-dried in a special device) is installed). The combustible volatile substances are accumulated in a special receiver or fed to a local gas network (for the cooking). Then that gaseous from the receiver are also fed into the combustion chamber of a gas turbine driving the electric generator. That makes it possible to divide the production of electric and thermal energy and use of the volatiles in (after gas turbines), is sent to the combustion chamber to generate heat (primarily for the supply of hot water (through its local network). Coal, from which a certain amount of the volatile matter has been extracted, is fed to another boiler where it is burned (as rules in a furnace with the bed combustion) to produce of the heat energy (for the heating). The expert evaluation shows that with this separation of the coal combustion (firewood) emissions of the gaseous pollutants into the atmosphere (especially - oxides of nitrogen and sulfur) is the significant reduced. Thermal energy for the heating is supplied to each house via a local heating network.

Structural scheme of the suggested technology is demonstrated on figure 1, where next elements are shown: coal warehouse, coal classifier, coal heater, layer furnace, firebox with the pulverized combustion, receiver, gas turbine, LHWS (line of the hot water supply), LGS (line of the gas supply) and LES (line of the electricity supply). Wind energy can be used as the power for the pump.

Harnessing of this new direction in the development of the new technologies for the providing of the isolated remote settlements with the electric and thermal energy (for the heating of the houses and water) is provided by the scheme. As a result of a step-by-step study of each element, the scheme will acquire a specific form.

Preliminary experiments for three types of solid fuels, whose deposits are located in Kazakhstan, suggest the optimal temperature for the heating of the coal to obtain the required concentration of the combustible components.

Scheme for providing an isolated village with various types of energy

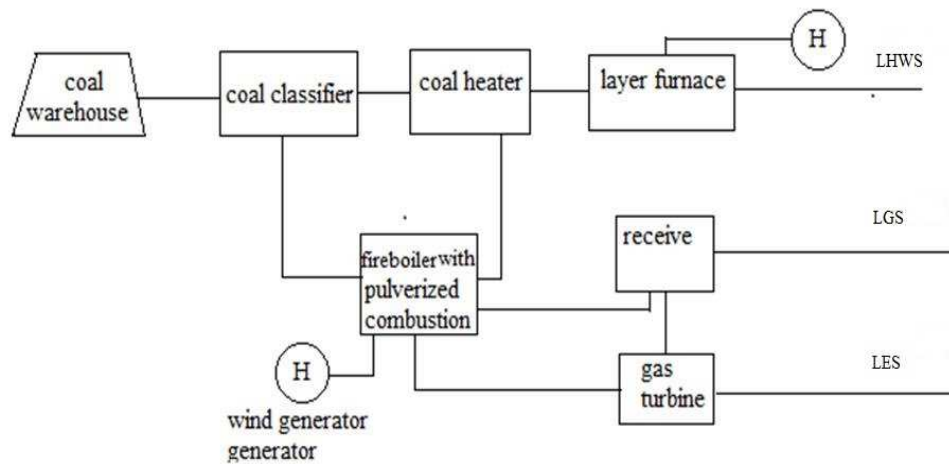

Figure 1: Technology of providing and isolated villages with various types of energy.

The composition and total yield of the combustible components of the gas, from the brown coal of Shubarkulsky (blue), Maykubensky (red), Sariadyrskoye (green) deposits are investigated.

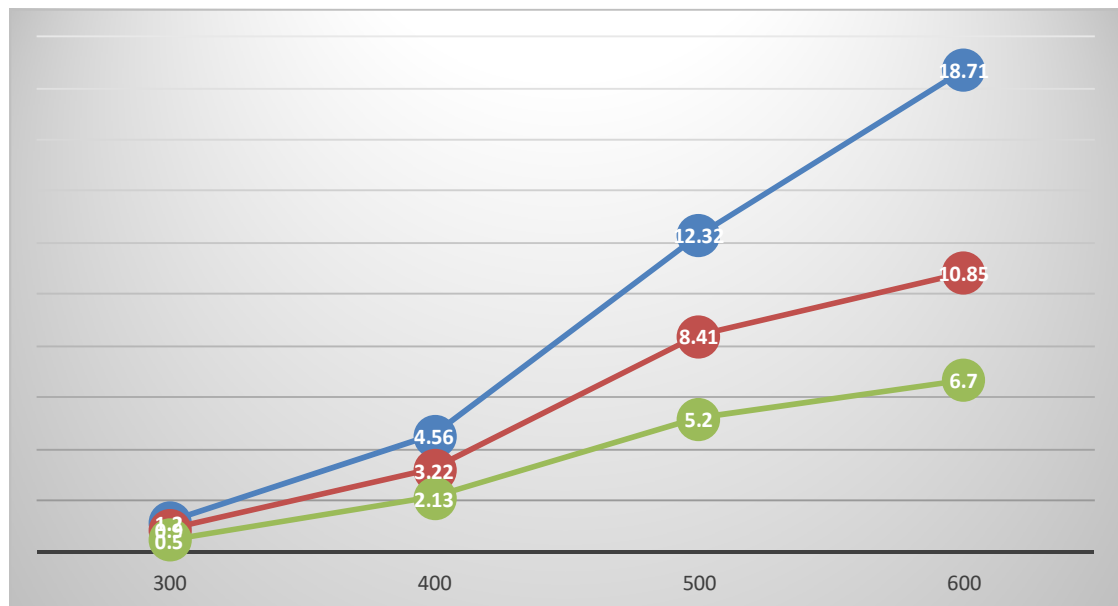

Figure 2: The total yield of CO, H<sub>2</sub>, CH<sub>4</sub> (in% vol) as a function of the heating temperature, °C.

The diapason of the temperature at the which researches were conducted is from the 300 to 600 ° C (horizontal axis). Reason of that is that the heating to the higher temperature will increase cost so that this method of the supplying isolated objects can make it unprofitable.

The obtained experimental data allow to determine of the optimum heat of the combustion of the produced gas.

Such a method of the autonomous supply by the various types of the energy involves the development of the technology and design of a generator for the production of the volatile substances from the coal or firewood in the required quantity, as well as a receiver of the necessary capacity to store gaseous fuel. The main element of the new power supply technology for a small settlement will be a gas turbine (with a reduced cost), capable of operating on un-purified volatile substances, with the increased suitability for the replacing blades and possibly of the repairing of the the combustion chamber. A gas turbine of this design will work with the less energy efficiency in the production of the electrical energy (however, the total energy use will not change because the residual heat will be converted into heat in the boiler).

### 3. CONCLUSIONS

Taking into account the simplification in the proposed technology of the gas turbine design and the elimination of the system for cleaning combustible volatile substances, the cost of the electricity, heat energy and gaseous fuel for the cooking will be quite acceptable for a family with an average and small income.

The technology being developed will make it possible to provide of the remote villages with a relatively small population by the most types of the consumed energy at an affordable cost. Technology will be in demand for the countries with the large territories with the low population density.

### References

- [1] Aliyarov B.K., Mergalimova A.K. On the advantages of using gas for firing boiler units // Proceedings of the International Scientific and Practical Conference dedicated to the 20th anniversary of ENU, Astana 2016.
- [2] S.K. Abdaliev, B.K. Aliyarov, M.B. Aliyarova Liquefied gas (associated or natural) and a local network - an acceptable alternative (pipe and / or balloon) gasification of small settlements in Kazakhstan // Bulletin of the National Academy of Sciences of the Republic of Kazakhstan 2011, No.2.
- [3] Bashmakov IA Improving the energy efficiency of energy supply in the northern regions of Russia. // "Energy Saving", 2017, No. 12
- [4] Kuntal Jana, SudiptaDe. Polygeneration using agricultural waste: Thermodynamic and economic feasibility study, Renewable Energy 74, February 2015(648-660)
- [5] AvishekRay, Kuntal Jana. Polygeneration for an off-grid Indian village: Optimization by economic and reliability analysis. Applied Thermal Engineering Volume 116, April 2017(182-196)
- [6] Rudachenko A.V. Gas-turbine plants for natural gas transport: textbook / A.B. Rudachenko, N.V. Chukhareva; National Research Tomsk Polytechnic University. - Tomsk: Publishing house TPU, 2010.
- [7] M.C.Barmaa R.Saidurbc. A review on boilers energy use, energy savings, and emissions reductions, Renewable and Sustainable Energy Reviews 79, November 2017(970-973)
- [8] YulongZhaoaShixueWang. Analysis of thermoelectric generation characteristics of flue gas waste heat from natural gas boiler, Energy Conversion and Management148, 2017(820-829)
- [9].Askarova, A. S.; Messerle, V. E.; Ustimenko, A. B.Reduction of noxious substance emissions at the pulverized fuel combustion in the combustor of the BKZ-160 boiler of the Almaty heat electropower station using the "Overfire Air" technology thermophysics and aeromechanics 23,jan 2016 (125-134)

# BIOMASS CONVERSION BY PYROLYSIS

Ph.D. Eng. Alexandru Isabela Doina – INMA Bucharest; 0721436534  
alexandruisa@yahoo.com

Biomass represents the biodegradable fraction of agricultural products, waste and residues, including vegetal and animal substances, forestry and related industries, as well as the biodegradable fraction of industrial and urban waste.

One of the forms of energy recovery of biomass is its thermochemical conversion by pyrolysis.

Currently, pyrolysis is considered a technology that leads to low emissions of potential pollutants.

## 1. INTRODUCTION

Defined as “the biodegradable fraction of biological products, waste and residues in agriculture (including vegetal and animal substances), forestry and related industries, including fisheries and aquaculture, as well as the biodegradable fraction of industrial and urban waste”, the biomass is the main contributor to renewable energy in the world.

Biomass is the only renewable source that can be used for all energy purposes, namely electricity, heat and transport fuel.

Biomass can come from [2]:

- conventional crops for non-food use: starch crops (corn, wheat, barley), oil seed crops (rapeseed, sunflower seeds) and sugar crops (sugar beet, sweet sorghum);
- dedicated crops: short-production cycle wood crops (willow, poplar) and herbaceous crops (herbs);
- forest by-products: residues from exploitation;
- agricultural by-products: straw, manure, etc.;
- industrial by-products: residues from the food and wood industries;
- biomass waste: demolition wood waste, sewage sludge and organic fraction from solid municipal waste.

EU Directive 2008/98/EC [7] defines the difference between by-product and waste:

- “waste” means any substance or object which the holder discards or intends or is required to discard;
- “by-product” is the substance or object that can be used directly without any further processing other than normal industrial practice and is produced as an integral part of a production process.

Currently, forest and agricultural waste as well as municipal waste are the main raw materials for electricity and heat generation from biomass. A small portion of sugars, cereals and vegetable oil is used as raw material for the production of liquid biofuels.

The amount of residues produced by a given crop may vary depending on agricultural practices, species or local climatic conditions.

The biomass represented by the energy crops (annual and perennial herbaceous plants, oleaginous, lignocellulosic plants) is obviously coming from the agricultural and forestry sectors.

Biomass types from agricultural crop residues are shown in Table 1 [4].

Table 1

<b>Agricultural crop</b>	<b>Biomass types</b>
<i>Residues from herbaceous crops</i>	
Wheat, barley, oat	Straw
Corn	Stalks, cobs
Rape	Stalks
Sunflower	Stalks and leaves
<i>Residues from tree crops</i>	
Fruit trees	Cut parts
Vines	Cut parts

The annual volume of manure and dejections differs greatly from one species to another depending on age and weight. Considering the possibilities of collecting and using manure energy (keeping animals outdoors or in small farms), only 50% can be considered available for energy production. Animal manure and dejections can come from cattle, pigs, horses, chickens, turkeys, ducks and sheep.

Secondary forest products are the total biomass resulting from forests during forestry activities. These include wood bark and chips resulting from tree tops and branches, as well as logs and thinning chips.

The main municipal waste is wood products, metal scraps, paper, cardboard, plastics, rubber, textiles, leather, household products, food scraps, broken dishes and glass, debris from interior repairs, foliage, amorphous substances (ash) etc.

Industrial waste includes industrial wood waste from timber factories, wood processing plants, and cellulose and paper factories. Nevertheless, much of the industrial waste comes from the food industry (fats, proteins, wet cellulosic material).

## 2. METHODOLOGY

There are several technologies for converting residues and waste into energy (heat, electricity, biofuel, biogas):

- direct combustion;
- co-firing;
- gasification;
- pyrolysis;
- anaerobic digestion

The choice of processing technology depends on the nature and structure of the biomass that constitutes the raw material or on the resulting products. Thus, direct combustion or gasification are used to produce heat and electricity, while anaerobic digestion for gas. Thermal pyrolysis can be used for all types of products (heat, electricity, gas, liquids, solids).

The diagram below highlights the major biomass conversion technologies, their raw material range and major fuel products for energy and heat use.

Biomass to energy pathway

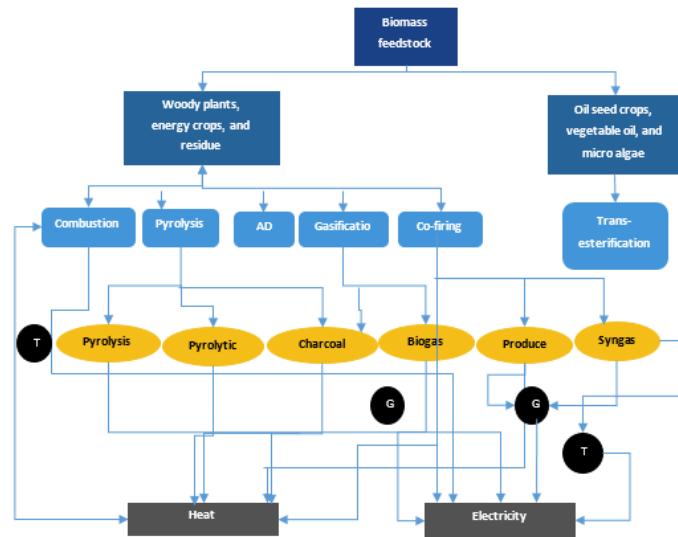

Source: Technavio, 2015

Figure 1 - Biomass-to-energy conversion technologies [6]

Table 2 presents a comparative analysis of the different technologies for the production of energy from biomass, taking into account various parameters.

Table 2 [6]

Parameter	Combustion	Anaerobic digestion	Gasification	Pyrolysis
Resource	Mainly solid biomass	Wet biomass	Mainly solid biomass	Mainly solid biomass
Raw material	Wood logs and chips, agricultural residues, energy crops	Manure and sewage sludge	Wood chips and pellets and agricultural residues	Wood chips and pellets and agricultural residues
Temperature °C	700-1400	Not applicable	500-1300	380-530
Pressure (MPa)	>0,1		>0,1	0,1-0,5
Drying	Not essential	Not essential	Necessary	Necessary

**Pyrolysis** consists of the thermal decomposition of biomass in the absence of oxygen. It is a fundamental chemical reaction that is the precursor of combustion and gasification processes. Products resulting from biomass pyrolysis include biofuel, bio-oil and gases, including methane, hydrogen, carbon monoxide and carbon dioxide.

The biomass for pyrolysis is generally composed of three main groups of natural polymeric materials: cellulose, hemicellulose and lignin. Primary products obtained from the decomposition of hemicellulose and cellulose are condensable (liquid) vapors and gas. Lignin decomposes in solid, liquid and gas products.

## BIOMASS LIQUEFACTION via PYROLYSIS

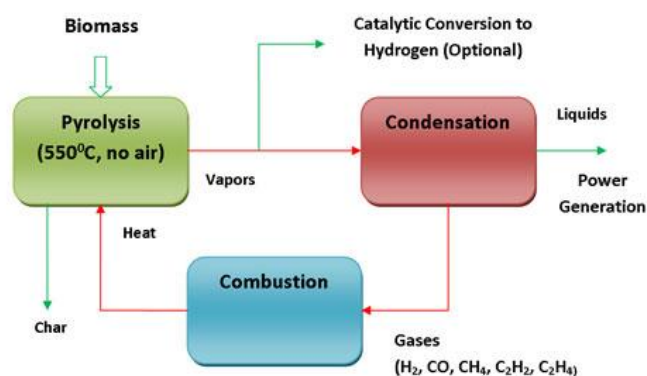

Figure 2 Process conditions for pyrolysis of biomass [3]

Biomass is usually pre-treated before pyrolysis. Biomass pre-treatment technologies can be divided into five categories: mechanical (grinding, chopping, extruding), thermal (steam explosion, microwave irradiation), chemical (treatment with acids, bases and ionic liquids), biological (fungi) and combinations thereof.

Depending on the thermal environment and the final temperature, pyrolysis can generate either a solid substance rich in carbon, called carbon, biochar, coal or coke, at low temperatures (below 450°C) when the heating rate is slow, or volatile substances at high temperatures (higher than 800°C) with fast heating rates. Volatile substances can be partially condensed to obtain a liquid fraction leaving a so-called “non-condensable” gas mixture.

Char is a solid carbon residue with low ash content.

At an intermediate temperature and at relatively high heating rates, the liquid product resulting from biomass pyrolysis is bio-oil. It is characterized by a complex chemical composition: carboxylic acids, aldehydes, alcohols, water vapour and tar.

The gaseous product is synthesis gas (syngas) composed of carbon dioxide, carbon monoxide, methane, hydrogen, and hydrocarbons with two carbon atoms in different proportions.

Pyrolysis processes can be classified in slow pyrolysis and fast pyrolysis.

Both types of pyrolysis generate solid biofuel products with different characteristics, even when produced from the same raw biomass material. The most significant differences include: the specific surface evolution resulting from the development of a porous structure during the pyrolysis process, the average pore size and pore size distribution (i.e., the micropores and macropores fraction). [5]

Fast pyrolysis is a thermochemical process during which a lignocellulosic biomass is rapidly heated to about 500°C in the absence of oxygen and then rapidly cooled in a reactor. The process converts biomass into carbohydrate-based compounds that include condensable vapors which are then condensed into liquid bio-oil, the primary product of fast pyrolysis.

Fast pyrolysis is characterized by high heating speeds and short vapour retention times. This generally requires a raw material prepared in the form of a small particle sizes and a form which rapidly removes the vapors from the hot solids. There are a number of different reactor configurations that can do this: ablative systems, fluidised beds, agitated or moving beds, and vacuum pyrolysis systems.

Pyrolysis also produces carbon (coal or biochar), flammable gases and vapors (including methane, hydrogen and carbon monoxide), which can be burned to heat the reactor, thus supporting the fast pyrolysis process. Thus, fast pyrolysis produces approx. 60% bio-oil, 20% biochar and 20% syngas.

Among the advantages of fast pyrolysis are:

- The process of obtaining bio-oil is relatively simple and fast;
- All biomass components can be transformed into a fuel product;
- Pyrolysis reactors are relatively simple.

Slow pyrolysis is characterized by lower heating rates, relatively long retention times of solids and vapors, and occurs at a lower temperature than fast pyrolysis, usually 400°C.

Low temperature and higher exposure time favours the formation of the solid product.

Slow pyrolysis produces approx. 30% bio-oil, 35% biochar and 35% syngas.

The two processes are schematically shown in Fig. 3

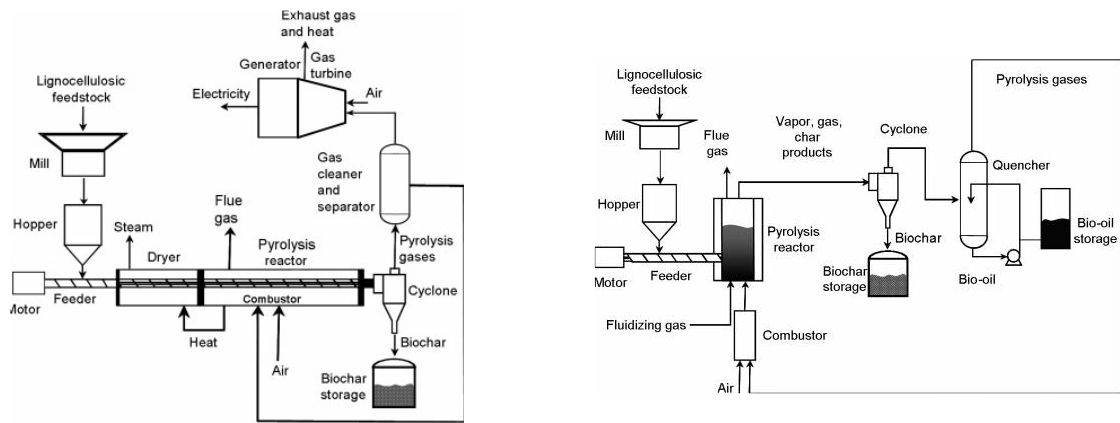

Figure 3 [1]

slow pyrolysis

fast pyrolysis

### 3. CONCLUSIONS

Biomass is the only renewable source that can be used for all energy purposes, namely electricity, heat and transport fuel.

Currently, forest and agricultural waste as well as municipal waste are the main raw materials for biomass electricity and heat generation.

Pyrolysis consists of the thermal decomposition of biomass in the absence of oxygen. Products resulting from biomass pyrolysis include biofuel, bio-oil and gases, including methane, hydrogen, carbon monoxide and carbon dioxide.

Depending on the thermal environment and the final temperature, pyrolysis can generate either a solid substance rich in carbon or volatile substances.

Pyrolysis processes can be classified in slow pyrolysis characterized by lower heating rates, relatively long retention times of solids and vapors and fast pyrolysis with high heating rates and short retention times of vapors.

Among the advantages of pyrolysis are:

- the use of waste such as the one resulting from wood processing (bark, sawdust, etc.) or agricultural residues (straw, manure, etc.);
- converting low energy biomass into high energy density liquid fuels;
- potential to produce chemical substances from biological resources.



## References

- [1] David A. Laird, Robert C. Brown, James E. Amonette, Johannes Lehmann, *Review of the pyrolysis platform for coproducing bio-oil and biochar*, John Wiley & Sons, Ltd 2009
- [2] Cigolotti V.-*Biomass and Waste as Sustainable Resources*, Springerlink, 2012
- [3] Salman Z. – *Biomass Pyrolysis Process*, Bioenergy Consult, 2015
- [4] Manual-Renewable Energy Sources, Bucharest 2012
- [5] <http://biocharforcarboncapture.com/research/fast-and-slow-pyrolysis>
- [6] [www.technavio.com/blog/five-processes-being-used-to-turn-waste-into-energy](http://www.technavio.com/blog/five-processes-being-used-to-turn-waste-into-energy), 2015
- [7] Directive 2008/98/EC of the European Parliament and of the Council of 19 November 2008 on waste and repealing certain Directives

# TECHNOLOGY FOR THE RECOVERY OF ZOOTECHNICAL WASTE THROUGH THE PROCESS OF ANAEROBIC DIGESTION

Eng. Bălan Vică<sup>1)</sup>, PhD. Eng. Voicea Iulian<sup>2)</sup>, PhD. Stud. Eng. Găgeanu Iuliana<sup>2)</sup>, PhD. Stud. Eng. Cujbescu Dan<sup>2)</sup>, PhD. Stud. Eng. Persu Cătălin<sup>2)</sup>, PhD. Eng. Dilea Mirela<sup>3)</sup>, PhD. Eng. Ungureanu Nicoleta<sup>3)</sup> PhD. Eng. Moga Corina Ioana<sup>4)</sup>

<sup>1)</sup>Mido Rom Electronic SRL, <sup>2)</sup>INMA Bucharest, <sup>3)</sup>University Politehnica Bucharest

<sup>4)</sup>DFR SYSTEMS SRL

E-mail: *balanvica2017@gmail.com*

## ABSTRACT

An important consequence of animal farming is represented by the production of important quantities of manure or organic residues. Normally, these organic residues from animal husbandry are recovered, mainly as an important source of organic matter and mineral elements for agricultural soils, but for their adequate degradation is also possible to use anaerobic fermentative processes, thus obtaining biogas (bioenergy) and digestate which can be used as fertilizer. Anaerobic digestion is a biochemical process through which, organic complex substrates (plant biomass and waste, manure, organic waste, residual water, sludges from sewer systems, etc.) are decomposed, in the absence of oxygen up to the state of biogas and digestate, by various types of anaerobic bacteria. The gaseous mixture formed by CH<sub>4</sub> (max. 80%) and CO<sub>2</sub> (min 20%) together with small quantities of H<sub>2</sub>, H<sub>2</sub>S, mercaptans, water vapours and traces of NH<sub>3</sub>, N<sub>2</sub>, constitutes biogas.

## INTRODUCTION

Fossil fuels are limited resources, concentrated in few geographical areas of our planet. This creates, for countries outside these areas, a permanent and insecure state of dependence on the import of energy resources. Most European countries are highly dependent on fossil energy imports from regions rich in fossil fuels such as Russia and the Middle East. Developing and implementing renewable energy systems, such as biogas from anaerobic digestion based on national and regional resources will increase the sustainability and security of national energy reserves and reduce dependence on energy imports [1, 2]. The use of fossil fuels, such as lignite, anthracite, raw oil and natural gas, converts carbon stored for millions of years into the Earth's crust and releases carbon dioxide (CO<sub>2</sub>) into the atmosphere.

The increase of atmospheric CO<sub>2</sub> concentration has as consequence the global warming effect because carbon dioxide is a greenhouse gas (GHG). Biogas combustion also releases CO<sub>2</sub>. However, the main difference compared to fossil fuels is that of the origin of biogas carbon, which is recently taken from the atmosphere, by the photosynthetic activity of the existing plants. Therefore, the carbon cycle in biogas is closed within a very short period of time (between one and several years). Biogas production through the process of anaerobic digestion also reduces emissions of methane (CH<sub>4</sub>) and nitrogen oxide (N<sub>2</sub>O) resulting from the storage and use of animal manure as a fertilizer. The greenhouse effect potential of methane is 21 times higher and the nitrogen oxide is 296 times higher compared to carbon dioxide, [3]. Therefore, the use of biogas instead of fossil fuels for the production and transport of energy reduces CO<sub>2</sub>, CH<sub>4</sub> and N<sub>2</sub>O emissions, thus contributing to the reduction of global warming. Anaerobic digestion is a biochemical process through which complex

---

<sup>1</sup> Bucharest street Petre D.Ionescu, nr.51., tel: 0762618596, e-mail: *balanvica2017@gmail.com*

organic substrates (plant biomass and waste, manure, organic waste, wastewater, sewage sludge, etc.) are decomposed, in the absence of oxygen up to the state of biogas and digestate, by various types of anaerobic bacteria. The use of animal manure as raw material for the anaerobic digestion process has some advantages due to its properties:

- Content in inoculant of natural anaerobic bacteria.
- High water content (4-8% DM in liquid manure), acting as solvent for the other co-substrates and ensuring adequate biomass homogeneity and fluidity.
- Cheap and easy accessible, being collected as residue from zootechnical farms.

In recent years, another type of raw material has been tested and introduced to undergo the anaerobic digestion process: the so-called energy plants, which are grown especially for the purpose of producing energy / biogas. Energy plants are represented by herbaceous plants (*Miscanthus*, corn, rapeseed, etc.) and woody plants (willow, poplar, oak), although for the latter, it is necessary to apply a special pre-treatment for delignification, [4, 5].

Substrates of the anaerobic digestion process can be classified according to their origin, dry matter content (DM), methane production, and other criteria. When substrates with a dry substance content smaller than 20% are used, the process is called wet digestion or wet fermentation. In this category are included manure and organic waste from the food industry. When using substrates with dry substance content higher than 35%, the digestion type is called dry digestion or dry fermentation. Dry digestion is typical in the case of energy crops and silage materials, [2, 6]. The choice of the type and quantity of raw material for obtaining the mixture of substrates subjected to the anaerobic digestion process depends on dry matter content, as well as carbohydrate, lipid and protein content.

During the anaerobic digestion process, a very small amount of heat is generated, compared to the case of aerobic decomposition (in the presence of oxygen), such as composting. The energy contained in the chemical bonds of the substrate mainly remains stored in the biogas produced, in the form of methane, [7, 8]. The process of biogas formation is the result of successive stages in which the initial substances are continuously decomposed into smaller molecules. Specific groups of micro-organisms are involved in each stage. Four main stages have been highlighted in the anaerobic digestion process: hydrolysis, acidogenesis, acetogenesis and methanogenesis. During hydrolysis, relatively small amounts of biogas are produced. Biogas production reaches its peak during methanogenesis. Methanogenesis is a critical stage of the entire digestion process, consisting of the slowest biochemical reactions in the process, [8]. Methanogenesis is strongly affected by working conditions. Raw material composition, charge rate, temperature and pH are examples of factors influencing methanogenesis. Overheating the digester, temperature variations or a massive penetration of oxygen usually causes methane production to stop [9].

Therefore, biogas produced through the process of anaerobic digestion is cheap and constitutes a source of renewable energy, producing, after combustion, neutral CO<sub>2</sub> and offering the possibility to treat and recycle an entire variety of agricultural residues and by-products, various bio-residues, organic residual waters from the industry, household waters and sewage sludges in a sustainable and environment friendly manner. Simultaneously, biogas brings a great number of social-economic benefits, not only for farmers directly involved in its production, but also for the entire society. For all these reasons, biogas resulted from anaerobic digestion processes constitutes one of the main priorities of the European Strategy on biofuels and renewable energy.

## **METHODOLOGY**

In order to conduct the experimental tests, an experimental model of modular installation for obtaining bioenergy through advanced dry and wet methanogenesis – MGA, was used. The two digesters, fitted inside the modular container, used for obtaining biogas

(bioenergy) through the process of wet anaerobic digestion (Reactor 1 - fig. 1) and respectively dry anaerobic digestion (Reactor 2 - fig. 1) are actively monitored and controlled using a programmable logic controller (PLC), programmed through the means of a graphic operator interface, represented by an operation terminal – OT. Thus, in order to ensure a mesophilic fermentation regime, the PLC will allow the heating of the two digesters up to the optimal temperature chosen by the user. After processing the entry data received from the 6 temperature sensors, the control of the recirculation pump with heating agent will be performed sequentially. During the process of dry and wet anaerobic digestion, depending on pH evolution in the two digesters, the PLC will automatically adjust the value set for pH, switching on the pump that recirculates pH correcting solution by opening and closing electro valve 5 (EV-%). When it will be needed to add pH correction solution to reactor 1 (wet digestion process), electro valve 7 (EV 7) will also be opened and when pH correction is needed in reactor 2 (dry digestion process), electro valve 6 (EV 6) will be opened. In order to homogenize the mixture in reactor 1, the PLC will automatically and sequentially control the agitation / homogenization system, comprised of a gearmotor and agitator with pallets, at an interval predetermined or set by the user. In the case of reactor 2, the liquid accumulated and deposited at the bottom of the vessel will be percolated by means of pump P3 and introduced again in the digester by means of nozzles; the percolation process is also achieved and controlled by the PLC of the advanced methanogenesis modular installation (MGA). When the pressure of biogas resulting from dry and wet anaerobic digestion processes will exceed 0.75-1 bar, value indicated by the pressure sensor (PT) on the operation terminal (OT), the PLC will command the drive of a vacuum pump (P5) and the opening of electro valve 8 (EV 8), thus allowing biogas accumulation in the reservoir.

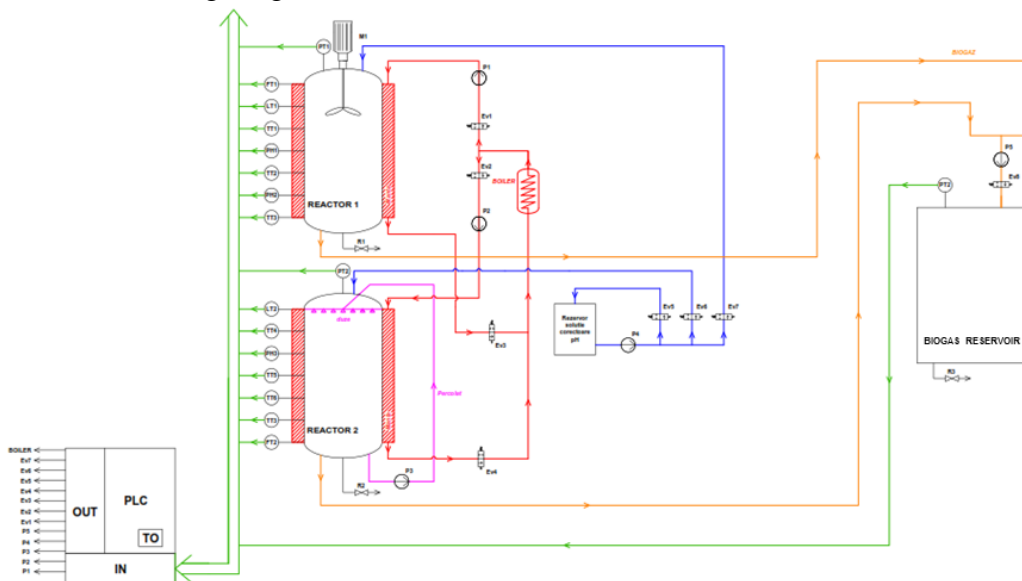

Figure 1. Process diagram on the operation of the modulated experimental installation for the production of bioenergy through advanced methanogenesis of agricultural waste - MGA

The raw material for the process of dry anaerobic digestion was: 50% hash made of 35% chopped straws with 65% Miscanthus, in combination with 50% sugar sorghum. For the process of wet anaerobic digestion, the raw material was represented by manure (55%) mixed with food organic waste 45% (potato peel, fruit residues, etc.) generated within a agro-zootechnical micro-farm. These materials were used in order to demonstrate the utility and functionality of this type of reduced scale biogas installation for an agro-zootechnical micro-farm. The operating characteristic of the two bioreactors (digesters), component parts of the modular installation, is that they have a discontinuous operation, consisting in supplying them with the two types of raw materials described above, thus feeding them with batch that will

undergo anaerobic digestion, after which it is completely evacuated, and then a new portion is introduced into the digester and the process is repeated, therefore the type of anaerobic fermentation is discontinuous or in batches. Material supply is achieved at the upper part of digesters and evacuation is performed at the bottom part. Temperature inside digesters should be maintained constant and therefore, it needs to be permanently monitored. The necessary energy for the operation of the modular installation is ensured by a system with photovoltaic panels fitted above the container and equipped with a battery group for storing energy. After the fermentation process generates biogas, it is consumed using a biogas generator, resulting energy that is stored in the same battery system.

The parameters of the anaerobic digestion process chosen to be monitored and controlled using the installation's automation system were the following ones:

- the temperature of the anaerobic digestion process was 40°C;
- the pH of the process was set and maintained at 7.5;
- the retention time in the digesters was 40 days;
- C/N ratio in the two digesters was 21;
- moisture of the mixture in the wet fermentation digester was 90%;
- moisture of the mixture in the dry fermentation digester was 40%.

The experimental research of analysing the composition of biogas resulting from the process of dry anaerobic digestion was conducted using a system for determining biogas composition. - COMBI IR. The Mentor/ComIR Series. The system uses the latest miniature infrared technology for the detection of CH<sub>4</sub> and CO<sub>2</sub>. Each sensor has a 0-100% volume range which is necessary for the biogas application. The use of infrared sensors means that the level of CO<sub>2</sub> can be measured accurately and the CH<sub>4</sub> sensor cannot be disrupted if high levels of H<sub>2</sub>S are present. The unit is fitted with the following sensors: 0-100% Volume CH<sub>4</sub> (infrared), 0-100% Volume CO<sub>2</sub> (infrared), 0-200 ppm H<sub>2</sub>S. The testing methodology required biogas composition to be determined 3 times per day for 40 days, as long as the experiment was conducted. The average volume of CH<sub>4</sub> per fermentation day, the average volume of H<sub>2</sub>S per fermentation day, respectively the average percentage volume of CO<sub>2</sub> per fermentation day were determined.

In figures 2 and 3 are presented the graphic representation obtained by processing, using Microsoft Excel program, the preliminary data on the composition of biogas obtained through the process of dry, respectively wet anaerobic digestion.

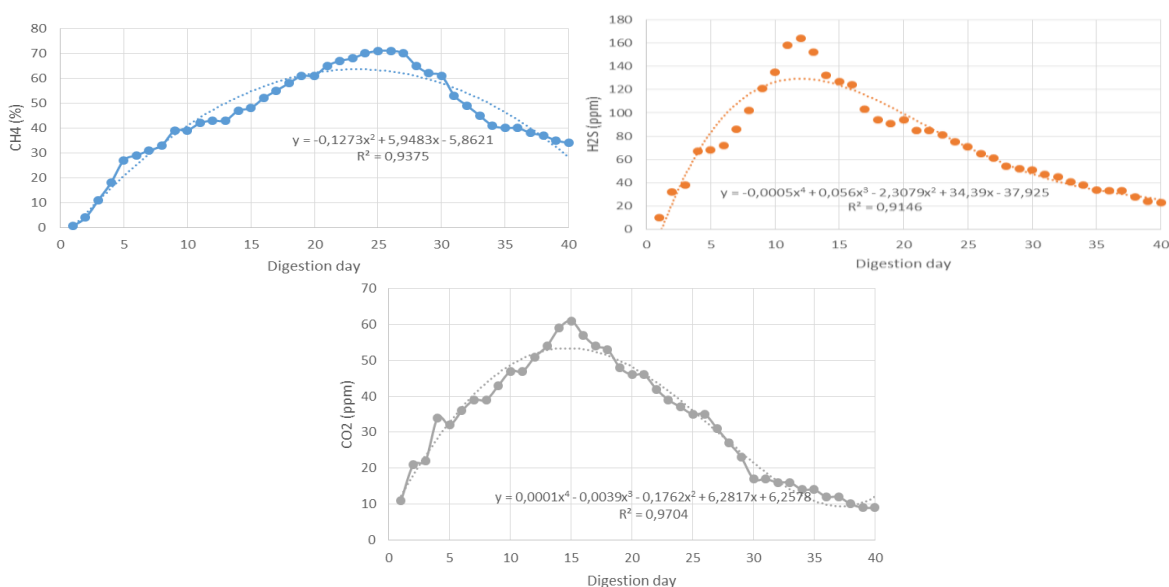

Figure 2. Graphic representation on the composition (CH<sub>4</sub>, H<sub>2</sub>S, CO<sub>2</sub>) of biogas resulted from the process of wet anaerobic digestion

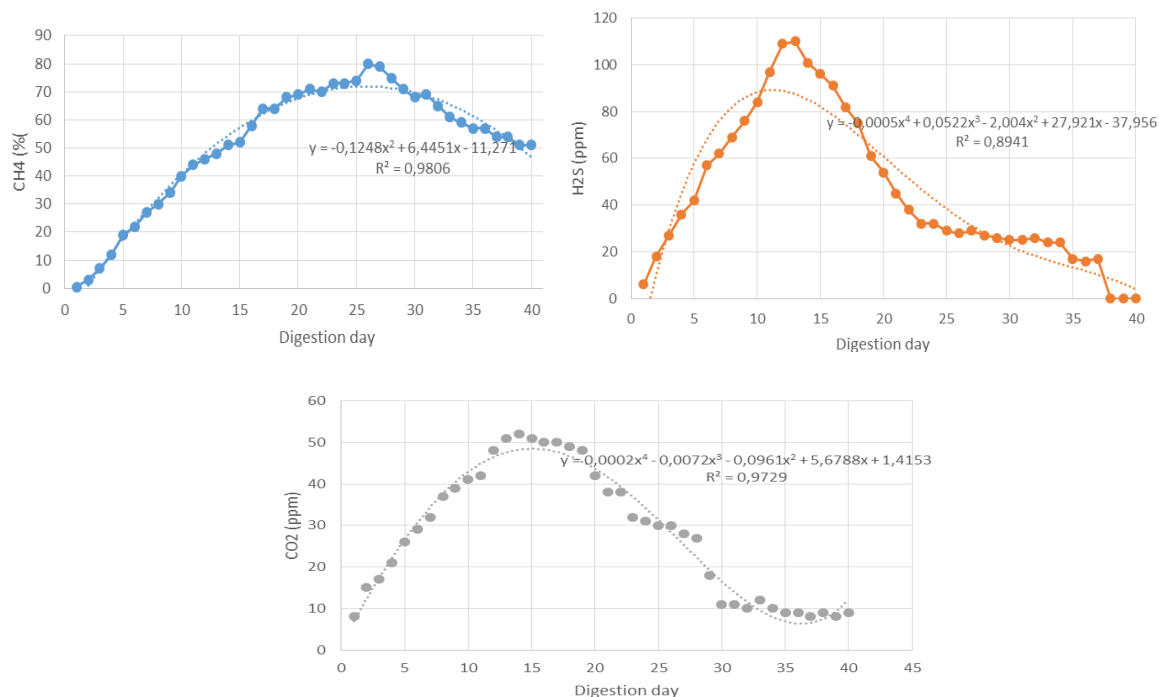

Figure 3. Graphic representation on the composition (CH<sub>4</sub>, H<sub>2</sub>S, CO<sub>2</sub>) of biogas resulted from the process of dry anaerobic digestion

The maximum H<sub>2</sub>S concentration in the composition of biogas obtained through the process of wet anaerobic digestion was 162 ppm and was recorded in the 13<sup>th</sup> fermentation day, while in the case of dry anaerobic digestion, the maximum hydrogen sulphide concentration was 115 ppm, being recorded in the 14<sup>th</sup> fermentation day. The maximum CO<sub>2</sub> concentration in the composition of biogas obtained through the process of wet anaerobic digestion was 61 ppm, and the average value for the 40 days of digestion was 33 ppm. For the process of dry anaerobic digestion, the average CO<sub>2</sub> value recorded in biogas composition in the 40 days of dry anaerobic digestion was 28 ppm, with a maximum value of 52 ppm, recorded in day 14.

## CONCLUSIONS

Based on the experimental data resulted, the following conclusions can be drawn:

1. Maximum CH<sub>4</sub> concentration in the composition of biogas obtained through the process of wet anaerobic digestion was 72% and it was recorded in day 25 of fermentation. In comparison, in the case of dry anaerobic fermentation, the maximum CH<sub>4</sub> concentration recorded was 81% in day 26 of fermentation.
2. Average CH<sub>4</sub> value recorded in the composition of biogas for the 40 days dry anaerobic digestion experiment was 44%, and in the case of wet anaerobic digestion, the average methane value was 41%.
3. Wet anaerobic digestion generated in the 40 days of the experiment a total quantity of 10.97 m<sup>3</sup> of biogas, with an average daily value of 0.27 m<sup>3</sup>.
4. Dry anaerobic digestion generated a total quantity of 10.26 m<sup>3</sup> of biogas, with an average daily value of 0.26 m<sup>3</sup>.
5. Thus, the biogas resulting from the two anaerobic fermentation processes presented a chemical composition that allowed its successful burning in a biogas generator and its

conversion into electricity that can be used in various applications within an agro-zootechnical micro-farm.

**Acknowledgement:** This work was supported by a grant of the Romanian National Authority for Scientific Research and Innovation, CNCS/CCCDI –UEFISCDI, project number PN-III-P2-2.1-BG-2016-0266, within PNCDI III, project entitled "Optimizing the composition of biomass mixtures for obtaining high quality pellets", ctr. 24 BG / 2016, a grant of Romanian National Authority for Scientific Research and Innovation, CNCS/CCCDI –UEFISCDI, project number PN-III-P2-2.1-PTE-2016-0183 (25/2016 –Improved flotation treatment technology for heavily loaded wastewaters) within PNCDI III and of Romanian National Authority for Scientific Research and Innovation, CNCS/CCCDI –UEFISCDI, project number **PN-III-P1-1.2-PCCDI-2017- 0566** (ctr. Nr. 9 PCCDI/2018- COMPLEX SYSTEM OF INTEGRAL VALUABILITY OF AGRICULTURAL SPECIES WITH ENERGY AND FOOD POTENTIAL, COMPONENT PROJECT 3 -Valuation of the energy potential of certain species of agricultural plants).

## References

- [1]. Hagos K., Zong J., Li D., Liu C., Xiaohua L., *Anaerobic co-digestion process for biogas production: Progress, challenges and perspectives*, Renewable and Sustainable Energy Reviews, vol. 76, pp. 1485-1496, 2017;
- [2]. Chiumenti A, Borso F, Limina S., *Dry anaerobic digestion of cow manure and agricultural products in a full-scale plant: Efficiency and comparison with wet fermentation*, Waste Management, vol. 71, pp. 704-710, 2018;
- [3]. Kothari R, Pandey A.K., Kumar S., Tyagi V.V., Tyagi S.K., *Different aspects of dry anaerobic digestion for bio-energy: An overview*, Renewable and Sustainable Energy Reviews, vol. 39, pp. 174-195, 2014;
- [4]. Zhang C, Su H., Baeyens J., Tan T., *Reviewing the anaerobic digestion of food waste for biogas production*, Renewable and Sustainable Energy Reviews, vol. 38, Pages 383-392, 2014;
- [5]. Mao C., Feng Y, Wang X., Ren G. *Review on research achievements of biogas from anaerobic digestion*, Renewable and Sustainable Energy Reviews, vol. 45, pp. 540-555, 2015;
- [6]. Zhang Q., Hu J., Lee D., *Biogas from anaerobic digestion processes: Research updates*, Renewable Energy, vol. 98, pp. 108-119, 2016;
- [7]. Divya D., Gopinath R, Merlin Christy P., *A review on current aspects and diverse prospects for enhancing biogas production in sustainable means*, Renewable and Sustainable Energy Reviews vol. 42, pp. 690-699, 2015.
- [8]. Maria D.F., Barratta M., Bianconi F., Placidi P, Passeri D., *Solid anaerobic digestion batch with liquid digestate recirculation and wet anaerobic digestion of organic waste: Comparison of system performances and identification of microbial guilds*, Waste Management, vol. 59, pp. 172-180, 2017;
- [9]. Kakuk B., Kornél L. K., Szuhaj M., Rákhely G., Bagi Z., *Adaptation of continuous biogas reactors operating under wet fermentation conditions to dry conditions with corn stover as substrate*. Anaerobe, vol. 46, pp. 78-85, 2017.

# SUPERIOR VALORIFICATION OF LENTIL FLOUR AND APPLICATION IN BREAD PRODUCTS

Adriana Elena Boeriu<sup>1</sup>, Cristina Maria Canja<sup>2</sup>, Adrian Măzărel<sup>3</sup>  
Transilvania University of Braşov, Romania  
Department for Engineering and Management in Food and Tourism

## ABSTRACT

Traditional raw materials (wheat flour, rye flour) used in bakery industry no longer meet the current consumer requirements. The modern trends in healthy nutrition are now heading towards a nutritionally balanced, nutritious food supply that provides the daily intake of nutrients needed to support normal metabolism and healthier lives.

To keep up with what has been shown, the bakery industry is turning attention to other sources of raw materials, sources able to meet the current needs and requirements of consumers. Thus, the present study aims at exploiting the nutritional valences of lentil in bakery products, being well known the fact that lentil is remarkable because of a special nutritional character and poorly exploited by the food industry at present.

**Key words:** lentil, bread, nutritional balance.

## 1. INTRODUCTION

Contemporary food styles are increasingly using resources that have not been enough exploited until nowadays, resources originated from the various eating habits of the Oriental people, especially arab people. Lentil (*Lens culinaris* or *Lens esculenta*) is a legume category with valuable nutritional properties, easy to prepare and consumed in the Middle East - India, Turkey, Egypt, Iran. Plant origin protein intake provided by lentil consumption covers about 65% of daily requirements, compared to 4% the proportion of animal protein. Taking into account the nutritional aspect illustrated in Table 1, the main types of lentil contain a large number of nutrients, such as proteins - 8,93g/ 100g lentils, carbohydrates 19,94g/ 100g lentils, fibers 7,82g/ 100g lentils, lipids 0,37g/ 100g lentil nutrients that contribute to the natural fortification of bakery products.

Table 1. Nutritional value of lentil grain per 100g of product

Nutritional value/ 100g of lentil [g]	
Protein	8,93
Carbohydrates	19,94
Fiber	7,82
Fats	0,37

Generally, legumes constitute a multivalent source, providing carbohydrate, protein and fiber intake, as well as vitamins and minerals. The proportion of protein that retrieved in legumes varies between 17...40%, compared with 7...13% in cereals, being approximately equal to that of 18...25% animal protein. The addition of legumes under different forms in bakery products increases the proportion of food fibers, starch, minerals and vitamins. Compared to traditional bakery products made from traditional ingredients (wheat flour, rye, corn), traditionally improved products by addition of legumes in various shapes and

<sup>1</sup>Braşov, 148, Castle Street, email: adriana.boeriu@unitbv.ro



proportions are distinguished by a higher nutritional value. In addition to wheat flour, rye flour, commonly used for bakery products, legumes are also used to obtain flours with different granulations which will be later used in various technological processes to obtain new products with improved characteristics.

Table 2. Vitamins and nutrients content of lentil grain per 100g of product

Type of vitamin	Amount [mg]	Type of nutrient	Amount [g]
Vitamin B <sub>1</sub>	0,33	Copper	0,50
Vitamin B <sub>2</sub>	0,14	Iron	6,59
Vitamin B <sub>3</sub>	2,10	Magnesium	71,28
Vitamin B <sub>6</sub>	0,35	Manganese	0,98
Vitamin B <sub>12</sub>	0,00	Phosphorus	356,4
Vitamin C	2,97	Potassium	730,6
Vitamin E	0,22	Sodium	3,96

The natural fortification of bakery products supports nutrition of people with various health deficiencies. According to WHO and FAO worldwide, there are over 2.5 billion people with various deficiencies that can be solved by and with the help of food fortifiers. Food fortification is, according to the research conducted by Svetlana Popel (2010), the most effective and accessible way to provide the population with the amount of vitamins and micronutrients needed for proper development. The additional fortification of consumer food products, especially wheat flour, bread and bakery products, is the one that achieves in the easiest mode the goal, reaching to the most of the population.

Fortification of food is done deliberately in order to improve their nutritional quality and to bring health benefits. At the same time, in the view of some specialists (Valeria Turfani, Valentina Narducci, Alessandra Durazzo, Vincenzo Galli, Marina Carcea), this practice is considered an intervention that can unbalance the nutritional profile of foods, vitamins and minerals artificially added to a product, being modified from a biological point of view, being difficult to assimilate by the body. The most consumed and affordable foods are bread and bakery products. In this context, the present study emphasizes the natural fortification of bread by the superior valorization of the lentil, which is concretized by the substitution of a variable quantity of wheat flour with flour obtained from three types of lentils - red lentils - *Roseus Lens Culinaris*, brown lentils - *Brunus Lens Culinaris* and Venetus *Lens Culinaris* - green lentils.

## 2. METHODOLOGY

The working protocol of the researches carried out to concrete the present study was carried out according to Figure 1 and in the first stage it was aimed at obtaining lentil flour, taking as a raw material the three types of lentil – red, green and brown, obtaining the mixture of wheat flour and lentil and obtaining the types of bread.

The sensory aspects of the obtained samples have been evaluated with scoring points using the hedonic scale of taste counted 1 – 9 taking into account the appearance – crust and crumb, taste, flavour.

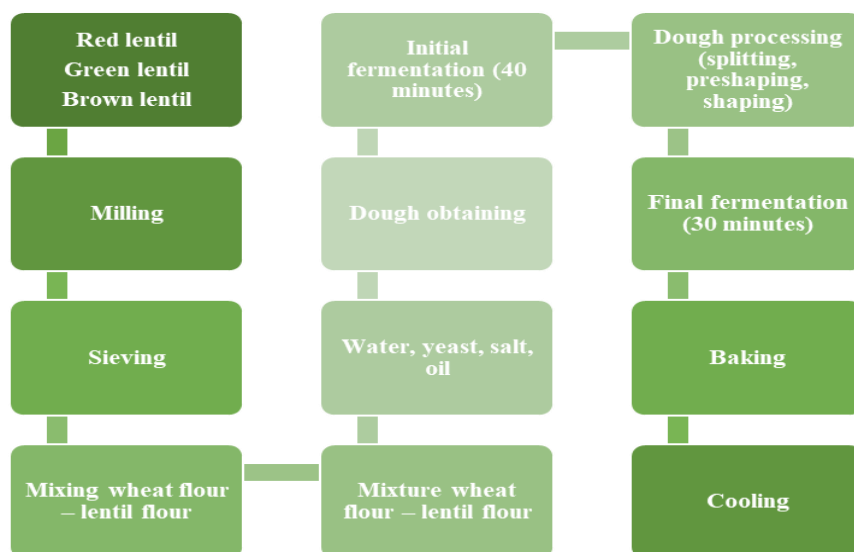

Fig. 1. The working flow diagram

The lentil flour used was obtained in the General Technologies in the Food Industry Laboratory of the Faculty of Food and Tourism and had as a raw material three types of lentils purchased from specialized store - red lentils, green lentils and brown lentils. This was milled with the laboratory mill and mechanically separated on the Makarov laboratory device. For the research, the fraction of lentil flour with the same granulation (75...80 $\mu\text{m}$ ) as that of baking wheat flour (75...80 $\mu\text{m}$ ) (Table 2 - Technological characteristics of wheat flour) was used.

Table 3. Technological characteristics of wheat flour

No.	Determined parameter	Value obtained	Minimal value according to STAS	Maximum value according to STAS
1.	Acidity, °T	2,73	2,6°T	2,8°T
2.	Wet gluten content, %	31,9	26%	-
3.	Hydration capacity, %	68,9	60%	-
4.	Moisture, %	14,6	14,5%	

The bakery products under study were obtained using a 3:1 mixture of wheat flour with lentil flour as the main raw material, bakery yeast, salt, vegetable fat (olive oil) and water. The method used for dough obtaining was the direct method, being created four types of bread having the characteristics shown in Table 3 and plotted in Figure 1.

Table 4. Physico – chemical properties of bread

Type of bread	Weight (g)	Volume (cm <sup>3</sup> )	Moisture (%)	Acidity(°T)	Ash (%)	Proteins (g)
<b>M</b>	241,6	297,6	41	2,8	1,25	13
<b>P1</b>	243,2	289,3	45,7	2,4	1,20	25
<b>P2</b>	251,1	289,5	45,5	2,2	1,29	24,8
<b>P3</b>	244,7	288,9	46	2,5	1,23	25,5

Taking into account the codification, M represents the bread obtained 100% of wheat flour, P1 with red lentil flour, P2 with green lentil flour, and P3 with brown lentil flour.

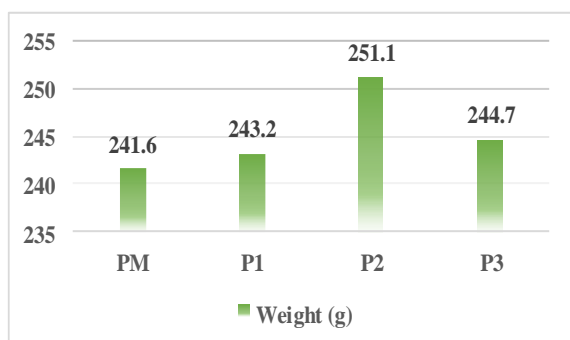

Fig. 2. Weight determination

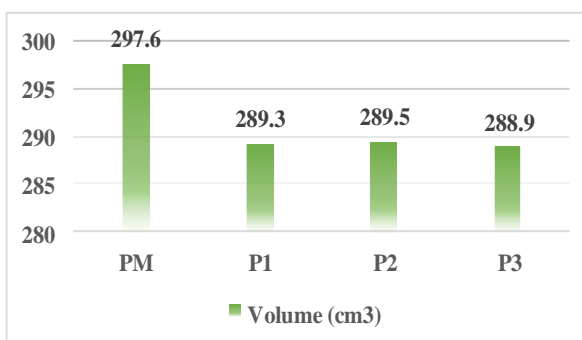

Fig. 3. Volume determination

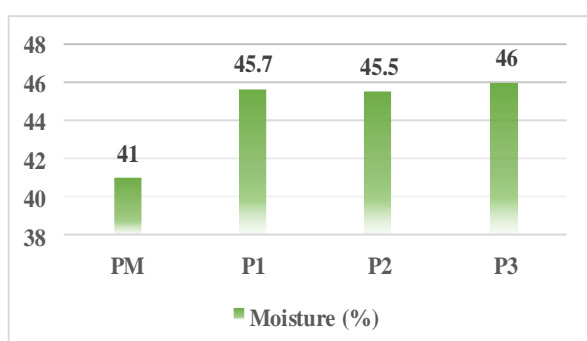

Fig. 4. Moisture determination

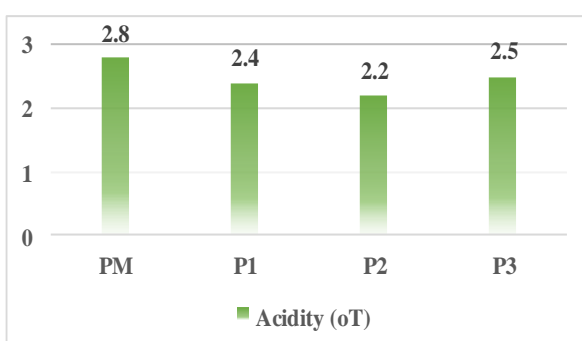

Fig. 5. Acidity determination

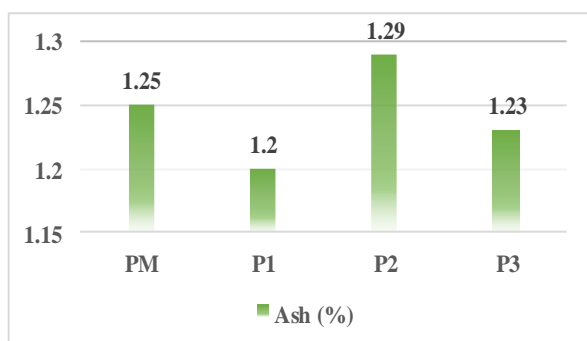

Fig. 6. Ash determination

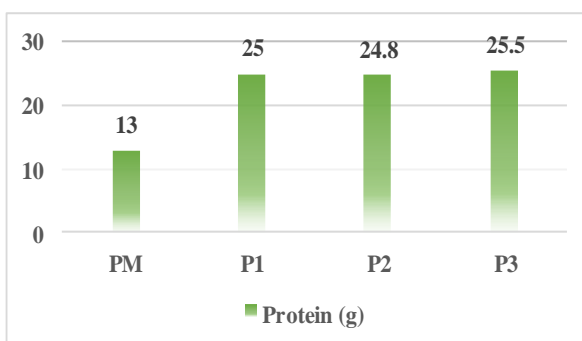

Fig. 7. Protein content of samples

According to the experimental research, the results from Table 4 were obtained, which show that from the physical point of view all three types of bread studied have improved values with a significant increase in moisture. Increased moisture provides a much longer (72h) degree of freshness, which makes it easier to consume loafed bread under normal conditions. The addition of lentil flour worsened the volume of samples, comparing to the blank sample, fact that is due to the decrease of gluten amount that is not able under these circumstances to form its tridimensional protein structure. The reduced quantity of gluten available to form the dough, reduced the ability to retain ferment gas during leavening, aspect that is reflected in the lower porosity and lower volume of bread with lentil flour addition.

Samples of bread were visually analyzed 10 days after production and no signs of disease (mold, stretch disease) were observed.

Taking into account the protein content, all bread samples obtained show considerable content of protein, the highest contribution being made by the green lentil.

The ash content of the obtained bread is largely influenced by the addition of lentil flour. Comparing with the blank sample with 1,25% ash, the sample with addition of green lentil flour – P2 had a higher ash content 1,29%. (Muste et al., 2015)

The acidity of bread was also sensitively influenced by the addition of lentil flour. This parameter increases with the addition of lentil flour in the dough from 2.8 to 2.2 °T. During the baking process, crumb acidity increased with addition of lentil flour, so the samples became more palatable and thick. None of the samples denoted an undesirable value of titratable acidity. The highest acidity has been developed in case of the addition of green lentil flour.

From the sensorial point of view, the flavor of bread fortified with lentil flour is greatly enhanced, the brown lentil bringing the aroma to that of traditional bread made with acid leaven. Bread made from red lentil flour had a distinctive orange color derived from the lentil pigment that holds its intensity during processing and baking. During the sensory evaluation, it has been concluded that the addition of lentil flour had a considerably influence concerning the colour, texture, flavour and taste of core related to the type of flour used. The total acceptability condition of bread with addition of lentil flour was considered as better or as good as blank sample.

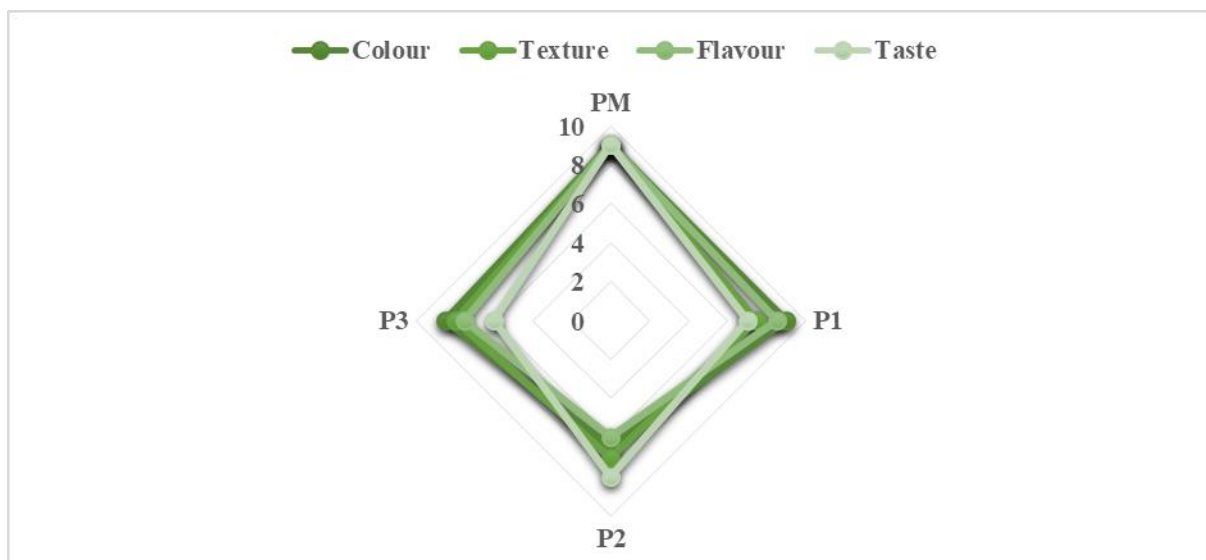

Fig. 8. Sensory evaluation of samples

### 3. CONCLUSIONS

Research in this paper demonstrates that the use of legumes with enhanced nutritional properties such as lentil has proven to be appropriate.

The natural fortification of bakery products with the three types of lentil flour - red, brown and green, has many nutritional advantages. The products thus obtained have a higher content in protein, fiber and carbohydrates.

The maximum protein level is reached by bakery products enriched with brown lentil flour P3, followed by P1 and P2.

From a technological point of view, all types of bread obtained by fortification with lentil flour have improved properties with increased moisture, which leads to increased production yields, implicitly to increased productivity. The volume of the products obtained shows a

slight decrease, fact that is observed from a sensorial point of view, but corrected by the improvement of the flavor and the appearance of both the shell and the core. The products thus obtained are much like the traditional products obtained with acid leaven.

The addition of lentil flour in bread products could constitute an important factor, contributing to the improvement of daily vegetable intake without affecting the nutritional customs of the actual consumer.

## References

- [1] Shyam S. Yadav, David L. McNeil, Philip C. Stevenson, *"Lentil: An Ancient Crop for Modern Times"*, Springer, 2007.
- [2] U. Hedrick, *"Cyclopedia of Hardy Fruits"*, The McMillan Company, revised, 1995.
- [3] Moldovan O., Păucean A., Vlaic R., Borș M. D., Muste S., *"Preliminary assessment of the nutritional quality of two types of lentils (lens culinaris) by near infrared reflectance spectroscopy technology (nirs)"* Bulletin UASVM Food Science and Technology 72(1) / 2015.
- [4] Turfani V., Narducci V., Durazzo A., Galli V., Carcea M., *"Technological, nutritional and functional properties of wheat bread enriched with lentil or carob flours"*, LWT - Food Science and Technology Volume 78, May 2017, Pages 361-366.
- [5] Brennan J. G., *"Food Processing Handbook"*, WILEY-VCH Verlag GmbH & Co. KGaA, Weinheim, 2006.
- [6] Jago W., *"The technology of breadmaking"*, The northern publishing CO, Liverpool, 1998.
- [7] Lazaridou, A. – Duta, D. – Papageorgiou, M. – Belc, N. – Biliaderis, C. G.. *"Effects of hydrocolloids on dough rheology and bread quality parameters in gluten-free formulations"*. In *Journal of Food Engineering*, vol. 79, 2007, p. 1033 – 1047, 2007.
- [8] Wieser, H. *"Chemistry of gluten proteins. In Food Microbiology"*, vol. 24, 2007, p.115-119, 2007.
- [9] Utrilla-Coello, R. G. – Osorio-Dcaz, P. – Bello-Pcbrez, L. A. Alternative use of chickpea flour in breadmaking: Chemical composition and starch digestibility of bread. In *Food Science and Technology International*, vol. 13, 2007, p. 323-327, 2007.
- [10] BOJŇANSKÁ T. - CHLEBO P. - GAŽAR R. - HORNA A. 2009. Buckwheat enrichment bread production and its nutrition benefits. In *European Journal of Plant Science and Biotechnology*, Global Science Books, vol.3, 2009, p. 49-55. ISSN 1752-3842, ISBN 978-4- 903313-42-9, 2009.

# **EXPERIMENTAL RESEARCHES ON DETERMINING THE QUALITATIVE WORKING INDICES FOR VEGETABLE AND LEGUMINOUS PLANTS SOWING MACHINE ON SANDY SOILS**

Bolintineanu Gheorghe<sup>1</sup>, Cujbescu Dan, Persu Cătălin, Găgeanu Iuliana, Voicea Iulian, Gheorghe Gabriel, Vlăduțoiu Laurențiu, Dumitru Iulian, Oprescu Remus, Ungureanu Nicoleta<sup>2</sup>, Vlad Cristina<sup>3</sup>  
<sup>1</sup>INMA Bucharest / Romania, <sup>2</sup>PU – Bucharest, <sup>3</sup>ICEADR – Bucharest

## **ABSTRACT**

Sowing is the agricultural work consisting in the introduction of seeds in the soil, at depths according to the agro-biological requirements imposed by each crop, evenly distributed, their covering with loose soil and the compaction or levelling of the soil, thus creating seed emerging and plant development conditions. The latest practice for vegetables is to granulate small seeds in order to ensure a distribution as even as possible when sowing with using machines (seed by seed), achieving at the same time a better nutritive environment and constant moisture during emergence. The paper presents a series of experimental researches conducted for determining seed flow, seed feed degree, optimal disc rotation speed, norm per hectare, sowing precision, seeding depth and the energetic indices for a machine destined for sowing vegetable and leguminous crops on sandy terrains, being able to operate with 45 HP of 65 HP tractors.

## **1. INTRODUCTION**

Sowing is the work that conditions at a great extent the level and quality of the production obtained, representing the work by which the seeds are incorporated into the soil where, under favourable conditions of moisture, heat and aerating, they emerge into new plants [1,3,7]. An adequate sowing work implies the simultaneous compliance of several conditions, starting with the preparation of the germination bed, but also the use of sowing machines that respect the highest quality working indices required for this work [2,5]. When sowing, the requirements for soil moisture and temperature, the depth of sowing specific to each crop, etc. are taken into consideration [6,8]. For this purpose, the optimal sowing season, the distance between rows and between plants per row and the seed quantity that ensures the established density must be complied with [4].

## **2. METHODOLOGY**

The vegetable sowing machine is destined for the sowing of leguminous plants and vegetables and hoeing crops on sandy terrains. It can operate on other types of soil where the land was previously well prepared.. The main requirements to be met by hoeing plants sowing machines are: to maintain a constant sowing depth; not to produce harm to seeds; to ensure distribution uniformity on the working with and length; to allow the adjustment of sowing depth and of the distance between rows; to allow to adjust seed norms within wide limits;

During the experiments, the following qualitative working indices were determined: seed flow rate; degree of feeding seeds; characteristics of the distribution disc and of the working regime; norm per hectare; sowing precision; sowing depth; energetic indices.

---

<sup>1</sup>bolintineanu\_gh@yahoo.com

Laboratory tests were conducted for establishing the working regime of the distribution disc and the quality of distribution, depending on seed particularities.

The main characteristics of seeds for which laboratory tests were conducted are presented in table 1.

Table 1: Main characteristics of seeds used during experiments

No.	Crop	Germination (%)	Dimensions (mm)			Mass of a thousand seeds gr/1000 seeds
			L	l	g	
1.	Carrot	78	2.10	1.45	0.80	1.03
2.	Tomato	70-85	3.70	2.70	1.05	1.55
3.	Cucumber	80-90	8.66	3.86	1.48	27.76
4.	Okra	70-90	5.11	-	4.21	54.66
5.	Pumpkin	90	19.52	11.90	4.74	347.66
6.	Salad	94	3.3	1.1	0.55	0.88
7.	Onion	80-95	2.50	1.80	1.60	3.19
8.	Cabbage	70-90	2.2	1.95	1.72	4.54
9.	Bell pepper	75-90	4.2	3.8	1.07	6.85

The seed quantity discharged by the distributor in the unit of time is determined by the number of seeds unloaded by the distribution disc in one complete rotation, the mass of seeds and the number of rotation of the disc in the unit of time. The number of seeds unloaded at complete disc rotation is theoretically equal with the number of orifices in the disc.

$$q = \frac{n}{100} \cdot MMB \cdot N \quad (1)$$

where -  $q$  is the quantity of seed unloaded by the distributor in the unit of time (g/min.);

-  $MMB$  is the mass of 1000 seeds (g);

-  $n$  is the number of orifices on the disc (-);

-  $N$  is the number of rotations of the distribution disc (rot/min).

It results that, theoretically, the quantity of seeds distributed in the unit of time, for the same values of  $n$  and  $MMB$  is directly proportional with the number of rotations of the distribution disc in the unit of time. Laboratory determinations have shown that the distributor's disc flow rate varies depending on the disc's rotation speed, by a curve, different to the theoretical one.

In figure 1 is presented the variation of flow with the number of rotations of the distribution disc per minute for bell pepper seeds, for the normal working regime of the exhauster.

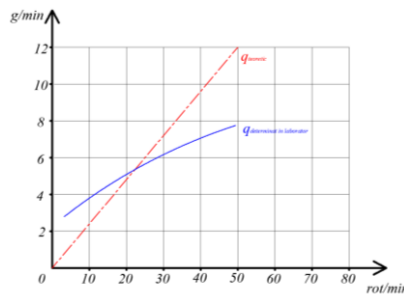

Figure 1: Variation of flow with the number of rotations of the distribution disc

Is deduced that up to a certain rotation speed of the distribution disc, the real flow rate is higher than the theoretical one and that as the speed increases, the real flow rate decreases below the value of the theoretical flow rate.

The difference between the value of the theoretical flow rate and the real flow rate obtained through experiments is due to the variation of the degree of feeding seeds ( $G$ ) by the distribution disc, which is given by the ratio between the number of seeds discharged by the disc in one complete rotation and the theoretical number (equal with the number of orifices on the disc).

At low speeds of rotation on the disc, the degree of feeding can have values higher than 1 (because 2-3 seeds can adhere to one orifice), and at higher speeds of rotation, the degree of feeding decreases due to orifices without any seeds adhering to them.

In table 1 are presented the average results obtained from laboratory experiments, for a number of five crops.

Table 2: Average degree of feeding seeds

No.	Crop	Number of orifices on disc	Transmission ratio	Disc orifice diameter (mm)	Average number of seeds debited by the disc in one rotation	Degree of feeding seeds
1.	Cucumber	14	0.8	2.5	18.0	1.28
2.	Tomato	30	0.43	0.75	29.8	0.99
3.	Pumpkin	7	0.43	5.0	11.1	1.59
4.	Carrot	80	0.8	0.75	109	1.35
5.	Okra	14	1.48	2.5	14.2	1.02

At the same speed of rotation of the distribution disc, the degree of feeding is influenced by the diameter of the disc orifice, as resulting from the graph in figure 2. It is observed that the degree of feeding the disc is smaller for orifices smaller orifices and increases for discs with larger orifice diameter. The degree of feeding decreases by increasing disc speed. At the same diameter of disc orifices, the degree of feeding is influenced by seeds mass and their characteristics.

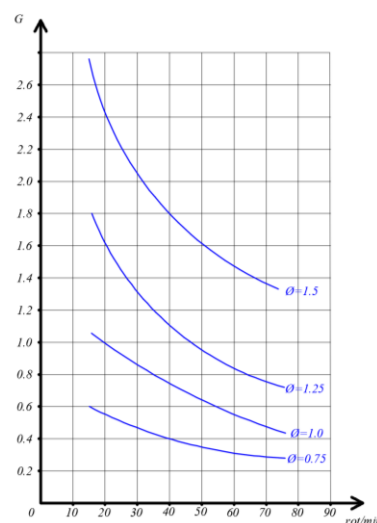

Figure 2: Variation of the degree of feeding the distribution disc depending on the disc orifice diameter and by its rotation speed for bell pepper crop



Based on experiments conducted on flow rate variation of the distributor, the optimal speeds of rotation and the diameter of disc orifices were established for the main vegetable crops (table 3).

Table 3: Optimal disc rotation speeds and disc orifice diameter for the main type of vegetable crops

No.	Crop	Disc orifice diameter (mm)	Optimal disc rotation speed (rot/min)
1.	Salad	0.50	80
2.	Carrot	0.50	70
3.	Tomato	0.75	60
4.	Onion	1.0	80
5.	Cabbage	1.0	50
6.	Bell pepper	1.25	50
7.	Cucumber	1.75	50
8.	Beet	1.75	40

Taking into consideration the agrotechnical demands for the distance between plants on row, the working speed and the transmission ratio at which the distribution disc has the optimal rotation speed, the minimum number of orifices on disc was established for each crop, according to the relation:

$$n = \frac{L}{a \cdot i} \quad (2)$$

where -  $n$  is the number of orifices on the disc;

-  $L$  is the space covered at one complete rotation of the drive wheel (cm);

-  $a$  is the distance between plants on row(cm);

-  $i$  is the transmission ratio.

From the laboratory tests resulted the following seed norms per hectare for the inferior and superior limits of distances between seeds per row, presented in table 4.

Table 4: Seeds norms per hectare for the inferior and superior limits of distances between seeds per row

No.	Crop	Speed Km.h <sup>-1</sup>	Orifice diameter (mm)	Number of orifices on disc	Transmission ratio ( i )	Resulted norm kg/ha	Usual norms kg/ha
1.	Salad	8.2	0.75	8	1.09	1.84	2.0
2.	Carrot	8.05	0.75	30	1.09	3.69	4.0
3.	Tomato	6.62	1.0	7	0.80	0.87	1.0
4.	Cabbage	6.66	1.0	5	0.80	0.36	0.4
5.	Onion	6.50	1.0	30	1.09	5.10	6.0
6.	Bell pepper	6.62	1.5	12	1.09	369.7	375.0
7.	Beet	7.80	2.0	10	0.80	9.27	10.0
8.	Cucumber	5.40	1.5	10	0.58	4.84	5.0

Flow instability on the coulter was determined for each crop, using the following relation:

$$i = \frac{\sqrt{\frac{\sum_{1}^n (q_m - q_i)}{n-1}}}{q_m} \cdot 100 \quad (3)$$

where -  $q_m$  is the average flow rate of the coultter;  
 -  $q_i$  is the flow rate obtained in one repetition;  
 -  $n$  is the number of repetitions.

From the determination on the seed flow rate on the coultter results that flow instability has the following values, presented in table 5.

Table 5: Flow instability on the coultter

No.	Crop	Distributor flow (gr/min)	Flow instability (%)	
			On row	On working width
1.	Salad	4.75	1.76	-
2.	Carrot	13.60	2.16	-
3.	Tomato	7.70	3.00	3.8
4.	Onion	29.00	1.96	-
5.	Cabbage	6.90	1.56	3.7
6.	Bell pepper	35.47	0.42	-
7.	Beet	38.26	0.65	4.0
8.	Cucumber	32.13	2.90	3.9

Laboratory and field tests were conducted in the purpose of establishing the qualitative indices of the sowing machine in the field. Determinations were conducted after plants emerged.

The indices that were established were the following ones: sowing precision as number of seed in one pocket; sowing depth; energetic indices.

In order to determine the seeding precision as number of seeds in one pocket, measurements were conducted on a distance ensuring sowing on a minimum of 100 seeds. Sowing precision as number of seeds in one pocket was given by the percentage of pockets where a number of seeds equal with the one adjusted (1 seed) was found. The average results obtained after processing the experimental data are presented in table 6.

Table 6: Sowing precision as number of seeds per pocket

No.	Crop	Adjusted distance between pockets (cm)	Speed (km.h <sup>-1</sup> )	Sowing precision as number of seeds per pocket		
				Pockets with one seed (%)	Pockets with multiple seeds (%)	Pockets without seeds (%)
1.	Carrot	3.0	5.3	53.7	36.3	10.0
			6.8	43.0	23.0	34.0
2.	Tomato	13.0	5.3	85.3	8.0	6.7
			6.8	74.3	8.3	17.4
			6.8	74.3	9.7	16.0
3.	Okra	8.0	5.3	97.0	1.0	2.0
			6.8	85.0	4.7	10.3
4.	Cucumber	15.0	5.3	85.3	14.7	-
			6.8	72.6	13.7	13.7

Depth of burring the seeds was determined after emergence by unearthing seeds and measuring the distance from the seed up to soil surface, for a number of 100 seeds in three repetitions. For determining the degree of uniformity of the sowing depth, were considered as good depth those found at the adjusted depth as well as those having a  $\pm 1$  cm deviation compared to the adjusted depth. Results are presented in table 7.

Table 7: Sowing precision

No.	Crop	Working speed (Km h <sup>-1</sup> )	Adjusted depth (cm)	Average achieved depth (cm)	Average deviation from the adjusted depth (cm)	Seed burial uniformity (%)
1.	Carrot	5.3	2	2.34	0.34	95.5
		6.8	2	2.12	0.12	93.7
2.	Tomato	5.3	3	3.10	0.10	98.4
		6.8	3	3.05	0.05	96.2
		6.8	3	3.10	0.10	96.8
3.	Cucumber	5.3	2	2.43	0.43	97.8
		6.8	2	2.21	0.21	95.7

### 3. CONCLUSIONS

Laboratory determinations have shown that the distributor flow rate varies according to the rotational speed of the disc, following a curve, specific for each crop, which is different from the theoretical one. It is deduced that up to a certain speed of rotation of the distribution disk, the flow rate is higher than the theoretical, but as the disc speed increases, the real flow rate decreases below the theoretical flow rate.

Instability of flow on coulter varies between 0.43% for bell pepper crop and 3.0% for tomato crop, and on the working width varies between 3.7% and 4%.

Sowing precision as number of seeds in one pocket varies depending the working speed, decreasing along with increasing speed and shows value between 53.7% and 43% for carrot crop, between 85.3% and 74.3% for tomato crops and between 85.3% and 72.6% for cucumber crop.

Working depth is maintained around the depth adjusted, the deviation ranging between 0.05 and 0.43 cm. The uniformity of burying seeds varies with the working speed and is ranging between 93.7% and 98.4%.

### ACKNOWLEDGEMENT

This work was funded by the Ministry of Research and Innovation, within the project entitled PN 18 30 01 01: “Experimental research on the aerial mapping of agricultural crops corresponding to the Agriculture 4.0 concept”, ctr. 18N/16.03.2018

### References

- [1] Brencu Molder L., Marin E. (2011). *Experimental researches of complex technical equipment sowing corn in narrow strips*. INMATEH International Symposium, ISSN: 978-973-0-11614-4, pp. 37-44;
- [2] Cârdei P., Manea D., Popescu S., Lazar S. *Mathematical model of the distribution device operating on the mechanical-pneumatic sowing machine SDC / Model matematic al procesului de lucru efectuat de aparatului de distribuție al semăntorii mecano-pneumatice SDC*, INMATEH - Agricultural Engineering, ISSN: 2068 – 2239, vol. 34, no. 2 / 2011, pp 5-12;
- [3] Cojocaru, I., Marin, E., Manea, D., *Ecological technology of soil working in conservative system and subsoilage by the performance of a technical equipment for the big power tractors*, Proceedings of the union of scientists, House of Anghel Kunchev University of Rousse, pp. 384-389, 2006;
- [4] Cujbescu D., Vlăduț V., Voicu Gh., Ungureanu N., *Researches on obtaining higher qualitative indices for the sowing work*, Engineering for Rural Development, 15 th International Scientific Conference Engineering for Rural Development, 25.-27.05.2016 Jelgava, LATVIA, ISSN 1691-5976, pp. 1305 – 1311;
- [5] Fornstrom, K. J., and S. D. Miller. (1989). *Comparison of sugar beet planters and planting depth with two sugarbeet varieties*. J. Am. Soc. Sugar beet Technol. 26 (3&4): 10-16;
- [6] Mitroi A., *Agricultural mechanization*, University manual, USAMV, DID, Bucharest, 2003;
- [7] Paraschiv ,G., ș.a., *Machines for working the soil, sowing and crop maintenance*, Printech Pub. House, ISBN 973-718-374-6, Bucharest, 130 pp., 2005;
- [8] Păunescu D., Brătucu Gh., Păunescu S., Atanasov At. (2010). *Research regarding the use of the GPS in monitoring agricultural sowing*. INMATEH - Agricultural Engineering, vol. 31 (2), pp. 79-86;

# PRINTERS CONTRIBUTION TO INDOOR LEVEL OF PARTICULATE MATTER AND SOLUTION TO REDUCE THIS EMISSIONS

Bordaş Adriana<sup>1</sup>, Istrate Irina<sup>1</sup>, Mariana-Gabriela Munteanu<sup>1</sup>  
University Politehnica of Bucharest, Faculty of Biotechnical Systems Engineering

## ABSTRACT

According to the United States Environmental Protection Agency (USEPA), indoor air pollution is in the top five risks to public health due to the negative impact to human health.

In some cases, the indoor pollution can be more than ten times higher than the outdoor air pollution, and in the case of harmful substances, their concentrations may even exceed the admissible norms by up to 100 times, even the indoors level of cancerous chemicals are between 5 and even up to 70 times higher than outdoors.

Considering these alarming statistics, our study was conducted to determinate how printers influence the level of particulate matter in indoors office buildings and the contribution of this concentration to outdoor pollution, as well as the presentation of economical and reliable ways to reduce the concentration of particulate matter in the indoor environment.

## 1. INTRODUCTION

PM stands for particulate matters and they are a widespread air pollutant.

Particulate matters represent the sum of all solid and liquid particles suspended in air, whose physical and chemical characteristics varying by location, being known by aerodynamic properties as following: large particles (between 2.5 and 10  $\mu\text{m}$ ), fine particles (smaller than 2.5  $\mu\text{m}$ ) and ultrafine particles (smaller than 0.1  $\mu\text{m}$ ) [1].

Common chemical constituents of particulate matter include sulfates, nitrates, ammonium, other inorganic ions such as ions of sodium, potassium, calcium, magnesium and chloride, organic and elemental carbon, metals (including cadmium, copper, nickel, vanadium and zinc) and polycyclic aromatic hydrocarbons (PAH). In addition, biological components such as allergens and microbial compounds are found in PM [2].

The size of particles has been directly linked to their potential for causing health problems, for this reason it is important to identify and to limit all the sources generating such particles, especially because in most locations from Europe,  $\text{PM}_{2.5}$  constitutes 50–70% of  $\text{PM}_{10}$  [2,3].

Another alarming fact it is that 92% of the world population was living in places where the WHO air quality guidelines levels were exceeded.

In Romania, the air has an annual average of 19  $\mu\text{g}/\text{m}^3$  of  $\text{PM}_{2.5}$  particles, that is 90% more than WHO safe level, and in Bucharest, the air has an annual average of 23  $\mu\text{g}/\text{m}^3$  of  $\text{PM}_{2.5}$  particles, that means 2,3 times WHO safe level. Moreover, in Romania, 14 497 people die because of an air pollution-related disease each year, among of these 88 are children [4].

Taking account these alarming statistics, this study investigated PM emissions from printers, which can significantly affect the submicrometer particle concentration levels in the office.

According with this fact, Queensland Institute of Technology shows that the average particle number concentration during working time is about 5 times higher than during non-working time in the office.

We chose this study because people who are living in urban areas spend up to 85–90 % of their time indoors where, at least, one printer is located, often without knowing that they might be continuously exposed to air pollution.

## 2. METHODOLOGY

### 2.1. AIR POLLUTION IN BUCHAREST

Bucharest is one of the most polluted cities in Romania, frequently registering exceedances of limit values and recommended limits (Table 1).

Table 1: Limite value for PM<sub>2.5</sub> and PM<sub>10</sub> [5]

Național limits (EU Air Quality Directive)				WHO Guidelines
Pollutant	Averaging period	Limit value (μg/m <sup>3</sup> )	Comments	Limit value (μg/m <sup>3</sup> )
PM <sub>2.5</sub>	Daily	-		25
PM <sub>10</sub>	Daily	50	Not to be exceeded on more than 35 days per year.	50
PM <sub>2.5</sub>	Annual	25		10
PM <sub>10</sub>	Annual	40		20

In Bucharest, cars traffic represents the major source of PM (50%). High emissions also occur from combustion for energy production in households and industry (40%) and other urban and industrial activities. There is no doubt that only a small part of the 10% is represented by indoor sources. The indoor pollution equipment has a local influence, at the emission source, and is affecting the users directly.

Although the level of pollution is among the highest in the country, in the last 10 years their concentration has fluctuated.

This decrease is due to the pressure from the European Union regarding the alignment with the recommended level for the protection of human health applying a series of measures imposed since joining the EU regarding the reduction of discharges from significant sources, aimed at: reducing the use of high-pollutant fuels (coal, oil), equipment with containment filters, catalysts and other types of pollutant containment installations, etc.

According to the data expose in the Air Quality Plan for Bucharest 2018-2022, the annual average values of PM<sub>10</sub> concentrations measured during 2017 are lower than obtained in the previous monitoring period, reaching in 6 of the 8 existing stations values lower than the limit value. However, at traffic station the values are maintained higher than limits, and the values measured at stations in the city show fluctuation and some periods in which the limit value is exceeded.

The limit value of PM<sub>10</sub> is exceeded on small areas in the northern, central and southeastern part of Bucharest. The contribution of industrial operators to VL overruns is significant. Higher concentrations of PM<sub>10</sub> (35-40 μg/m<sup>3</sup>) were obtained on central area, adjacent areas and in arteries with high circulation. In peripheral areas, the annual average concentrations are between 30-35 μg/m<sup>3</sup>. In peri-urban areas, annual mean concentrations are in the range of 25 to 30 μg/m<sup>3</sup>.

The limit value for PM<sub>2.5</sub> is exceeded by extended areas in all sectors of Bucharest. The main sources responsible for the high values obtained are cars traffic (on main and secondary arteries) and residential heating, but the larger spatial dimension of overtaking is mainly due to the existence of an increased regional fund (over 65% of VL).

Concentration values range from 25 to 30 μg/m<sup>3</sup> in the central area, adjacent areas and in arteries with high circulation, while values exceeding 30 μg/m<sup>3</sup> are found in limited areas. In the residential areas which are not crossed by the heavily circulated arteries, the average annual concentrations are between 20-25 μg/m<sup>3</sup>. In peri-urban areas, annual mean concentrations are below 20 μg/m<sup>3</sup>.

## **2.2. PRINTERS TYPE AN CHEMICAL COMPOSITION OF PRINTING INK**

There are two types of printers on the market (generally): inkjet printers that use thermal energy to emit ink particles and laser printers (electro-photographic devices).

The first type of printers uses ink cartridges, and the second type uses solid toner (particles of 5-30  $\mu\text{m}$ ) stored in the toner pool and is composed of two main ingredients, pigments and plastic particles [6].

In general, the laser printers are more used because they have a superior print speed as against inkjet printer and are ideal for office activities where a large amount of documents are printed in a relatively short time.

### **2.2.1. Printer ink**

Inkjet cartridges contain minute ink nozzles (about 400), located in the printer head, from which ink is dispensed onto the paper. During printer use, the microscopic ink nozzles dispense ink onto the paper (4-5 picolitres/nozzle) according to the data command. Regardless of what cartridge is used, indoor ink can withstand 300 degrees due to its composition, subject to repeated heating/cooling cycles [6].

For maintain all the qualities of the printing process it is necessary to add special substances into the mix inside the ink cartridge. The major substances that modern ink cartridges contain are: deionized water (95%); ethylene glycol, it prevents the ink nozzles from clogging up and prolongs the life of the ink inside the ink cartridge especially through periods of insufficient use; ethylene-diamine-tetraacetic acid (EDTA), it forms a type of chemical trapping structure which catches the metal contaminants from the adhesive strip and prevents them from entering the cartridge or the printing head; ethoxylated acetylene diols, it keep the surface tension of the solution in the ink cartridge at the right level; three dyes - Yellow 23, Blue 199, Red 23 (contains copper in large amounts); cyclohexanone, it help the ink stick to the paper and not slide off or get smudged, and butyl urea for prevent cellulose fibres of the paper to form new H – bonds [7].

### **2.2.2. Solid toner cartridge**

Electro-photographic printers are using a low-power laser beam to capture an image and to reproduce it by means of a solid pigmented substance based on carbon powder, substance called toner. The light source determines the selective electrostatic charge of a photoconductive drum. The latent image is then developed by covering it with toner, is transferred onto the paper and is fixed [6].

A laser toner cartridge contains a mix of solids which isn't even the same in all laser printers; the mix may variate from a model of printer to another even if they are produced by the same manufacturer.

However, the basic components in all of them will remain the same, such us: polyester (85-95%); polypropylene wax, it prevents the toner from sticking to the rollers; carbon black, it imparts the colour black to polyester; pigment yellow, it is made up of a benzimidazolone compound; pigment red; pigment blue; fumed silica, it makes particles less prone to sticking to each other, and charge control agents which could include zinc, chromium, or iron [7].

## **2.3. CONTRIBUTION OF PARTICULATE MATTER FROM PRINTERS IN INDOOR ENVIRONMENT**

The principal factors governing particle concentration levels in indoors are: the contributions determined by the indoor sources (printers, PC, electrical equipments) and the ones from the outside air, the deposition rate of particles, the air exchange rate and

coagulation (although in this case, the particle coagulation rate is significantly lower the emission rate and it is insignificant).

Researches in this domain found an increase of particulate matters in indoors with the introduction of electrical devices (about 5 times higher than outdoors concentration) particularly printers and photocopy machines. More critical is the fact that many of the offices are not adequately ventilated to reduce the consequences of direct exposure.

In their study, Congrong H. et al., showed a clear diurnal variation in the indoor concentrations, with the average concentration of  $6.5 \mu\text{g}/\text{m}^3$  at one normal utilization on the printer (in a air conditioned office building). If we add this concentration to the existing level in Bucharest, the risk of office workers, where the limit value are exceeded, increases considerably without taking into account other internal sources.

Much worse is the fact that the exposure level of typography workers can reach twice the limit value, as Suhaimi S., Nurulilyana S. et al. demonstrated, after studying 46 typography.

The results of the study shows that particle emissions start immediately after the printer starts operating and the size distributions of the particles generated by the printer are monodisperse. More than that, the offices with air-conditioner show a higher concentration of particulate matters than those without mechanical ventilation (Table 2).

The particulate matter level of indoor air pollution was explained by: the dimension of the shop (10.9%), the number of sheets printed daily (6.8%) and by the total number of photocopy machine inside the shop (6%).

Table 2: Particulate matters level measured in typography [8]

	Mean ( $\mu\text{g}/\text{m}^3$ )
<b>PM<sub>2.5</sub></b>	31.1
Typography with air-conditioner	37.5
Typography without air-conditioner	20.6
<b>PM<sub>2.5</sub></b>	82.1
Typography with air-conditioner	85.2
Typography without air-conditioner	77.2

Among the factors that influence particle emission rates are: printer type, cartridge age and existence of filters (to 3D printers).

The printer operating with an old cartridge generated a lower total number of particles than when operating with a new cartridge, it generated more of the smaller particles, in the size range below 25 nm [8].

#### **2.4. THE INFLUENCE ON THE HUMAN HEALTH OF PARTICULATE MATTER**

Particulate matter is a key indicator of air pollution. Due to low aerodynamic diameter, small particles can travel over long distances in the atmosphere and they can cause a wide range of diseases that lead to a significant reduction of human life. The size of particles has been directly associated to their potential for causing health problems, such that, the smaller the particles are, the deeper they get into the body to deposit into the respiratory tract. Among the natural protective barriers to these particle located in nasal-breathing are the cilia and the mucus which act as a very effective filter for most particulates exceeding  $10 \mu\text{m}$  in diameter. But, at high exposure, it tends to lodge in the trachea (upper throat) or in the bronchi [9].

At the moment, particles that have the most impact on human health effects have been acknowledged to be those less than  $10 \mu\text{m}$  in diameter. These particles can penetrate within the respiratory tract beginning with the nasal passages to the alveoli, deep within the lungs due to their excessive penetrability. Particles between approximately 5 and  $10 \mu\text{m}$  are most

likely deposited in the tracheobronchial tree, while those between 1 and 5  $\mu\text{m}$  are deposited in the respiratory bronchioles and the alveoli, which can affect gas exchange within the lungs and can even penetrate the lung [9].

Finally, these particles will pervade into the blood stream to produce significant health problems. Particles, smaller than 1  $\mu\text{m}$ , usually, behave similar to gas molecules and will therefore penetrate down to the alveoli (deposition by diffusion forces), and can translocate further into the cell tissue and/or circulation system [9].

The health effects of particulate emissions depend on the size of the particles, like [10]: cardiovascular disease (when diameter is smaller than 0,1  $\mu\text{m}$ ), tumors (1 – 0.1  $\mu\text{m}$ ), skin and eye disease (1 – 2.5  $\mu\text{m}$ ), decreased lung function (2.5 - 10  $\mu\text{m}$ ).

In increase of  $\text{PM}_{2.5}$  level with 10  $\mu\text{g}/\text{m}^3$  in short-term (<24 h) increases the relative risk of daily cardiovascular mortality by 0.4% to 1%. Long term exposure to particulate matter is associated with incidence of coronary events, and this association persists at levels of exposure even below the current European limit values (Table 1).

It was also concluded that with a 5  $\mu\text{g}/\text{m}^3$  increase in estimated annual mean  $\text{PM}_{2.5}$  was associated with a 13% increased risk of coronary events, and a 10  $\mu\text{g}/\text{m}^3$  increase in estimated annual mean  $\text{PM}_{10}$  was associated with a 12% increased risk of coronary events [11].

More than that, estimates of the health impacts attributable to exposure to air pollution indicate that  $\text{PM}_{2.5}$  concentrations in 2013 were responsible for about 467 000 premature deaths originating from long-term exposure in Europe [12].

For these reasons, the air quality target and limit values set by the EU Air Quality have been transposed into national legislation, but what really needs to be considered are the safety limits identified by the World Health Organization which are much lower than the limits in the legislation (Table 1).

All of these effects may occur at people who use the printer frequently, alarming being that the mass deposition of particles emitted by printers into a human lung has been identified as 1.732  $\mu\text{g}/\text{m}^2 \cdot \text{min}$  [12].

## **2.5. SOLUTIONS TO REDUCE PARTICLES CONCENTRATION**

In order to reduce the particle level due to indoor emission sources, can be used mechanical air cleaning sources, natural solutions involving the use of phytoremediation and natural ventilation.

Mechanical sources involve extra costs and, in some cases, a device like this can cause hearing disruption, affecting the workers in the office.

Alongside conventional techniques to clean indoor air, environmental biotechnology such as phytoremediation, in which growing plants with associated microorganisms take up pollutants and degrade or detoxify them, may also be employed. Compared to the technical methods, phytoremediation technology is cheaper, environmentally friendly and can be used for a wider range of both organic and inorganic impurities. Studies have shown that ornamental plants have the ability to absorb, distribute and/or transport organic pollutants to microorganisms associated with higher plants living both in the rhizosphere and phyllosphere [14].

Their absorption capacity is influenced by leaf size, structure, the thicker layer of waxes, pubescence and surface roughness, and are recognized by the name "spider" (known in Romania as the "veil of the bride") - *Chlorophytum comosum*. The total amount of PM accumulated on the leaves of the spider plant ranged from 13.62 to 19.79  $\mu\text{g}/\text{cm}^2$ , and the gravity forces were not involved in PM accumulation on leaf blades. The amount of fine particulate matters was higher accumulated, because they are easier to photostabilizer [14].

In the case of the room's natural ventilation the danger can appear in certain time intervals, the concentration of particles introduced with fresh air to be very high due to intense



traffic or special events which can happen. For this reason, you should carefully select the optimal ventilation range and how to dispose internal pollutant equipment to minimize exposure.

### 3. CONCLUSIONS

The indoor concentration level of the particulate matter is significantly influenced by the use of printers, contributing to the overall pollution level by an average of  $6,5 \mu\text{g}/\text{m}^3$ , representing about 23% of the total emission average recorded in 2017. Practically, the indoor exposure level (considering only external sources and printer contribution when they are used) may fluctuate between 16.6 and  $41.9 \mu\text{g}/\text{m}^3$ . The most affected people being those whose offices are in the central area and the adjacent areas as well as along the large traffic arteries. Effects increase when the workspace is smaller because the dispersion will be done in a narrow space, increasing the direct exposure of workers (an increase of  $1 \text{ m}^2$  dimension of the office will reduce  $1.07 \mu\text{g}/\text{m}^3$  of  $\text{PM}_{2.5}$  indoor air pollution levels).

In order to limit direct exposure, it is indicated to put plants in the immediate vicinity of the printer and ventilate the room for the dispersion of the emitted particles.

### References

- [1] Gawronska H., Bakera B., *Phytoremediation of particulate matter from air by Chlorophytum comosum L. Plants*, Air Quality Atmosphere & Health, 2014;
- [2] World Health Organization, *Health effects of particulate matter - Policy implications for countries in eastern Europe, Caucasus and central Asia*, publicat în WHO Regional Office for Europe, 2013;
- [3] World Health Organization media center, *Ambient (outdoor) air quality and health*, site: [www.who.int](http://www.who.int), access data: 25.03.2018;
- [4] WHO Global Platform on Air Quality & Health, *Breathelife*, site: [www.breathelife2030.org](http://www.breathelife2030.org), access data: 25.03.2018;
- [5] S.C. WESTAGEM S.A., *Planul Integrat de Calitate a Aerului în Municipiul București 2018-2022*, Bucharest 2018;
- [6] Baruch, Z., *Sisteme de intrare/ieșire și echipamente periferice*, Cluj-Napoca, site: [www.users.utcluj.ro](http://www.users.utcluj.ro), access data: 19.03.2018;
- [7] Office Hacks, *What do ink cartridges contain?*, publicat în 2015, site: [www.blog.inkjetwholesale.com.au](http://www.blog.inkjetwholesale.com.au), access data: 20.03.2018;
- [8] Congrong H., Morawska L., Len Taplin, *Particle Emission Characteristics of Office Printers*, International Laboratory for Air Quality and Health, Queensland University of Technology, Brisbane, Australia, 2006;
- [9] Ki-Hyun K., Kabir E., *A review on the human health impact of airborne particulate matter*, published in Environment International, 2015;
- [10] Brüning Thomas, *Assessment of the Health Effects of Toner Particles on People in the Workplace*, BG Research Institute for Occupational Medicine, 2006;
- [11] Yixing D, Xiaohan X., *Air particulate matter and cardiovascular disease: the epidemiological, biomedical and clinical evidence*, Journal of Thoracic Disease, 2016;
- [12] European Environment Agency, *Air quality in Europe report*, 2016;
- [13] Suhaimi S., Nurulilyana S., Najib M., Ahmad F., *Predictive Factors of Particulate Matter Indoor Air Pollution and its Effect on Workers' Lung*, Asia Pacific Environmental and Occupational Health Journal, 2017;
- [14] Gawronska H., Bakera B., *Phytoremediation of particulate matter from air by Chlorophytum comosum L. Plants*, Air Quality Atmosphere & Health, 2014.

# RESEARCH REGARDING THE PROCESS OF MEDICINAL HERBS DRYING TECHNOLOGY

PhD. Eng. Caba Ioan Ladislau<sup>1</sup>, Phd. Stud. Eng. Laza Evelin-Anda<sup>1</sup>  
Phd. Eng. Vlăduț Valentin<sup>2</sup>, PhD. Eng. Păun Anișoara<sup>2</sup>, M. Cristea<sup>3</sup>

<sup>1</sup>)INMA Bucharest – Sucursala Timisoara / Romania

<sup>2</sup>)INMA Bucharest / Romania

<sup>3</sup>) SC Cantarprod SRL

Tel: 0256.499.336, E-mail: inmatm\_caba@yahoo.com

## ABSTRACT

*This paper aims at studying the technological process of dehydration of medicinal and aromatic crop plants and spontaneous flora, in order to determine the most suitable drying process and the technical-functional equipment. The artificial dehydration of food products medicinal and aromatic plants, although it is characterized by relatively high costs, is widely used because dried products have the weight and volume reduced and may be retain and use for a long time after harvest, maintaining food quality or the therapeutic quality (in the case of medicinal plants). At the same time can ensure the rigorous control of technological operations, so the final product complies with current food safety regulations.*

## 1. INTRODUCTION

Artificially drying of food products, medicinal and aromatic plants, is widely used because dried products have low weight and volume, can be easily stored and retains much better nutritional and therapeutic qualities. At the same time can assure a rigorous control of technological operations, so the final products comply with current food safety regulations [8, 10, 11, 12].

The teas constitute the most efficient way for extracting the active ingredients from the plant and, unlike the drugs do not cause unwanted side effects. But medicinal and aromatic plants are a source of raw materials for the extraction of active ingredients and oils, with particular value for many industries [3, 4, 8, 10, 11, 12].

The main areas for use of the medicinal and aromatic plants as well as products and active ingredients extracted from them are: in food in the form of teas, food additives, spices, colorings, sweeteners, preservatives, alcoholic or non-alcoholic drinks, for flavoring food products (chewing gum, chocolate) or nonfood (detergents) and maintenance for medical treatments, including aromatherapy cosmetics and perfume industry, deodorants products, shampoos, bath lotions, toilet soaps, toothpaste, mouthwash and as natural pesticides for plant protection [3, 8, 10, 11, 12].

Convection drying was and is the most widespread method of removing moisture from the plants because of the simplicity of the technological process and the many variants applicable (including the possibility of association with another drying principle), in short time and with a relatively low cost [2, 4, 5, 6, 9, 10, 11, 12].

Warm air constitutes the heating agent of the drying process, but he has the role of driving the processed material moisture evaporated. Heat and mass transfer during the drying process is conditioned by the drying agent parameters (speed, temperature and relative humidity of the warm air) and the linkage between the moisture and material [7, 9, 10, 11, 12].

The duration the dehydration process is chosen according to the physic and chemical characteristics of the plant so that after drying the moisture content not exceeding generally 14%. For plants rich in oils (like peppermint, thyme, or basil) drying temperature should not exceed 35 °C [1, 9, 10, 11, 12].

## 2. METHDOLOGY

Installation for dewatering of medicinal and aromatic plants on which have been made studies consists of a metal frame, trays placing the material to be dehydrated, enclosure walls and partitions, doors, and inspection cover, heat exchanger, a whole of the water supply, axial fan, valves for air control, electrical installation for command and control, measurement devices for the drying process parameters.

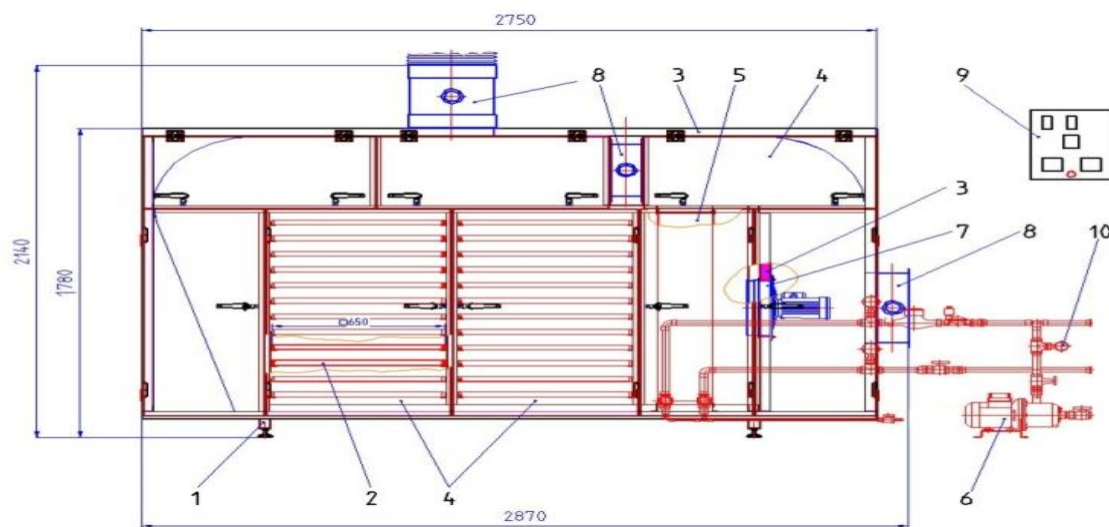

- |                     |                              |
|---------------------|------------------------------|
| 1. Metal frame      | 6. Whole of the water supply |
| 2. Trays            | 7. Axial fan                 |
| 3. Walls            | 8. Air dampers               |
| 4. Doors and covers | 9. Electrical installation   |
| 5. Heath Exchanger  | 10. Measuring instruments    |

Figure 1: Technological scheme of dehydrating medicinal and aromatic plants installation

Functioning of installation for dehydrating medicinal and aromatic plants is illustrated in technological scheme shown in Fig.1.

The Installation for dehydration works in batches, the duration of dehydration of a batch depends on the type of vegetable material is vegetable it's being dried, being lower for larger herbaceous plants and fruit. As it is shown in the technological scheme, the axial fan provides airflow through the radiator battery, which is heated by the hot water provided by boiler and then through plant material stacked in trays into the drying room. Because the bottom of the trays are provided with holes, some of the air flows vertically passing through the vegetable material placed on the trays, so that the drying process takes place in the entire volume of the product

After prescribing drying parameters, automatic drying cycle was started. At the end of the process, the fan and the water pump was stopped.

The amount of air circulated through the installation can be adjusted, during operation of the installation in automatic mode, using inverter or handling dampers. Air velocity through trays product is an important parameter, especially for medicinal and aromatic plants drying, too high speed can lead to lighter fragments with high degree of dehydration.

Recirculated air mode was obtained by the partial opening of the register control over the drying chamber and partial closing the admission register.

### 3. RESULTS

In the first experiment was use a herb called Chrysanthemum (Chrysanthemum), it has a detoxifying action and immunostimulatory over the body [11].

The plant was placed in the drawers by 600 g in each drawer, the initial sample weight being 9 kg. To keep the plant active principles, it was dried at 40 ° C.

Table 1: Sizes measured while performing the first experiment

De no.	Drying time [min]		Power [% P <sub>n</sub> ]	Medium temperature [°C]	Measured sizes		Calculated sizes		Obs.
	Between measurements Δt	Cumulated			Table sample m [g]	Qty of evaporated water in the measurement range Δm [g]	Humidity [%]	Drying speed [%humid/min]	
1	30	30	36	37	99.5	0.5	67.178	0.08	Preheating
2	30	60	36	40	94.63	4.87	60.33	0.3	
3	60	120	36	40.1	82.35	7.28	54.28	2.143	Constant speed drying
4	60	180	36	40	71.57	10.78	44.11	2.143	
5	60	240	36	39.9	58.44	13.13	35.4	2.143	
6	60	300	36	40.1	49.02	10.42	22.83	2.143	
7	60	360	36	40.2	42.32	6.7	20.49	0.80	Final drying
8	60	420	36	40	37.50	4.82	12.92	0.33	Cooling
9	60	480	-	29	35.47	2.03	7.92	0.06	

During the second experiment has been use a different type medicinal plant Aloe Vera (Aloe Barbadosis) this herbs are used for its antiseptic and anti-inflammatory properties [11].

The total amount of plant introduced into the dryer was 10.8 kg. The plant has been distributed in the dryer drawers each 720 g / drawer.

Registrations performed on the first experiment measured values are presented in table 3.

Table 2: Sizes measured while performing the second experiment

De. no.	Drying time (min)		Power (% P <sub>n</sub> )	Medium temperature (°C)	Measured sizes		Calculated sizes		Observation
	Between measurements Δt	Cumulated			Table sample m (g)	Qty. of evaporated water in the measurement range Δm (g)	Humidity (%)	Drying speed (%humid/min)	
1	20	20	36	38	99.58	0.41	75.98	0.06	Preheating
2	30	50	36	39	95.71	10.21	75.05	0.27	
3	60	110	36	40	85.45	10.46	73.7	2.67	
4	60	170	36	41	76.58	10.85	70.9	2.67	

5	60	230	36	41.3	63.08	13.55	65.66	2.67	Constant speed drying
6	60	290	36	41.5	52.46	10.62	56.30	2.67	
7	60	350	36	41.6	44.78	10.68	48.81	2.67	
8	60	410	36	42	35.85	10.93	36.03	2.67	
9	60	470	36	41.7	30.58	5.27	24.05	0.9	Final drying
10	60	530	36	40	26.96	3.62	14.98	0.34	
11	60	590	-	30	25.04	1.93	8.42	0.06	Cooling

#### 4. CONCLUSIONS

The products of medicinal and aromatic plants represent a high economic value on both domestic and foreign markets because they have a wide range of use. To achieve them are unnecessary especially when local resources are exploited the parameters of heating agent (hot water) ensures high enough temperatures for the drying agent in order to dry plants with higher and lower moisture and plants and those plants that present a wood structure. At the same time there are sufficient reserves as temperature and flow of heat to dehydrate fruits and vegetables properly prepared, if necessary even by slicing.

#### REFERENCES

- [1]. Banu C. & Colective, *"Manual of the Food Industry Engineer, Vol. I"*, Technical Publishing House, Bucharest 1998.
- [2]. Catana L. & Colective, *"Guidance for the establishment of a dehydration unit for vegetables and fruits"*, Ed. Printech, Bucharest 2008.
- [3]. Coiciu Evdochia, *"Medicinal plants in perspective"*, C.D.A., Bucharest, 1967.
- [4]. David P. *"Test report of Prototype Technology and Modernized Plant for Drying of Fruit and Vegetables"*, Program Relansin, Contract No. 1530 / 04.12.2001, 2004.
- [5]. Despa Gh. The technological study of the process of primary processing of medicinal and aromatic plants and the extraction and primary processing of active substances, Nucleus Program, contract no. 15 N / 27.02.2009.
- [6]. Dănescu A. *"Thermotechnics and thermal installations in agriculture"*, Didactic and Pedagogical Publishing House, 1967
- [7]. Dăscălescu D., *"Drying and its industrial applications"*, Technical Publishing House, 1964.
- [8]. Dihoru Al., Dihoru Gh., *"Plants used in digestion in humans and animals"*, Ed. Ars Docenti, Bucharest, 2008.
- [9]. Fader T. *"Test report of the prototype Plant for Dehydrated Fruit"*, Relansin Program, contract no. 1485 / 08.02.2001;
- [10]. Mihăilă C. *"Processes and industrial drying installations"*, Technical Publishing House of Bucharest, 1982
- [11]. Laza E-A., Andrei S., Pop A., Manea D., Matache M. *"Studies and research regarding the process of herbs drying technology"*, ISB INMA TEH' 2015, International Symposium: Agricultural and Mechanical Engineering, Bucharest 2015.
- [12]. Paun E. & Collective, *"Treated Medicinal and Aromatic Herbs, 1-2"*, Ed. Academics R.S.R. Bucharest.,1998.

# **THE RELATIONS BETWEEN CULTURAL LANDSCAPES, OPEN SOURCE HARDWARE AND OPEN INNOVATION IN RURAL DEVELOPMENT**

Alexandru Calcatinge, PhD<sup>1</sup>

“Ion Mincu” University of Architecture and Urbanism, Bucharest, Faculty of Urbanism,  
Department of Urban Planning and Territorial Development

## **ABSTRACT**

There are three strong concepts in this paper's title: cultural landscapes, open source hardware and open innovation. All of these concepts have, in my opinion, a strong relation to the rural development, and I will demonstrate this in the following paper. The cultural landscapes are the combined works of nature and humans, the open innovation is represented by the combined internal and external ideas that shape development based on new technologies, and open source hardware is the combination of readily available materials, open infrastructure and open design tools. All those concepts stand for freedom of ideas and principles used to develop the environment. Thus, this paper will create the missing link between them and rural development, building on the principles of open source.

## **1. INTRODUCTION – THE NEW OPEN INNOVATION PARADIGM**

One might wonder what does all the concepts from the paper's title have to do with rural development, and it is a fair question. In the previous TE-RE-RD paper I've built upon concepts as “Open Source Culture”, “Open Source Ecology”, “Open Source Urbanism” and “Open Source Hardware” and DIY in rural development. This paper is about to create the missing link between those concepts and “Open Innovation” at a Cultural Landscape scale.

But first, let me emphasize a little on the concepts that I am going to use here and on the structure of the paper. In the first chapter I will review the concepts described in the previous paper, as those two were created as being part of a whole, connecting the Open Source paradigms with the Cultural Landscapes paradigms. The link with the rural development is much needed, as this is the “site” where innovation should take place. In the last part of the paper, there will be an analytical link constructed on how all those relate to each other and benefit the local and regional communities.

The main paradigm that this paper will address will be the “open innovation” one, as the other paradigms were already discussed in detail in the last TE-RE-RD paper. First, what is open innovation? Without looking for any definitions, we must connect the term to the “open source” one, as those are strongly related. The term “open source” defines an open mentality in relation with the computer software production. Thus, an open source software product has its source code open to anyone that is interested in studying it or further developing it. This kind of mentality and culture was the key to delivering one of the most important open source project in the world: the operating system kernel named Linux. Since 1991 when its source code was made available on the Internet, the project is in constant growth and was an inspiration to other important open source software projects [1a] . Some projects you might have heard of, like most know Linux distributions Fedora, Debian or Ubuntu, but there are also smaller but influential ones, that can be put alongside the open innovation process, like

---

<sup>1</sup> UAUIM, str. Academiei nr. 18-20, 010014, București, România.

Hadoop – an open source software that is used for reliable, scalable and distributed computing and was developed by Yahoo and Apache, but now it is used and developed by companies like Google, Facebook, IBM, Twitter, Amazon and any other company that is working with Big Data. Git is another important project. It is a distributed version control system and is used by developers around the world for working on open source projects. TensorFlow, developed by Google, is an extensible neuron-based machine learning library, which is merely scratching the surface of the machine learning potential, but nevertheless it is a great piece of software. Hyperledger is an open source software that develops modular tools based on the blockchain technology to solve big commercial problems [1b]. All those projects discussed here had a strong impact on the way computation and collaboration in developing code is done. They are a living example that open source collaboration is the key to producing innovative assets.

Let us get back to the term of open innovation now. What does it mean really? Well, Henry Chesbrough said that “Open Innovation means that valuable ideas can come from inside or outside the company and can go to market from inside or outside the company as well” [2]. Chesbrough is believed to be the one that “invented” the term “open innovation” and in contrast to his approach, the creator of the Linux kernel, Linus Torvalds stated during the Open Source Leadership Summit of 2017, that “the real work is in the details” [3] and that he is a strong believer of the view that successful projects are 99 percent perspiration and only one percent innovation. Nevertheless, both views are important for a healthy process of innovation. Nowadays, the main question is not if you should innovate or not, but more about how to innovate and how to manage that process. And the key to this process is the community. This community is comprised of creators, just like computer programmers, architects, builders, engineers, artists and others.

Dealing with open innovation, there is one important aspect that we will not discuss in this paper: intellectual property. We will only discuss on the tools and the issues of accessing existing knowledge and technology. Thus, in the following chapters, I will emphasize on the relations between community and open source outcomes/projects and how they relate to the cultural landscapes and rural development.

## **2. THE COMMON PARADIGMS IN BUILDING RELATIONS**

During the process of building the relations between cultural landscapes, open source open innovation and rural development, there are several new concepts that I would like to emphasize on. Those are: service learning, and open source appropriate technology. Besides those, I will shortly bring into discussion previously discussed concepts like open source hardware and open source urbanism, in order to create a clear binding relation between all of those that relate to the cultural landscapes and rural development.

First, let us get back on the issue of accessing existing knowledge and technology. As Julien Penin stated, “open innovation paradigm does not focus on the condition of availability of existing technologies. (...) Openness is central in the case of upstream research. Those researchers must be open, in the sense that everybody should be allowed to use them without discrimination in order to create a dynamics where each stakeholder can use and enrich the open knowledge pool” [4]. Thus, the way we can access the already existing knowledge is a very important aspect of the open innovation paradigm.

Let us take the example of the Free/Libre Open Source Software movement. In this case, the access to knowledge is absolutely free and is also governed by permissive licences such as the General Public License (GPL) and LGPL. But the most important thing is that the FLOSS is a purely distributed process (around the entire world and between many companies,

individuals and different projects) and that it is fundamentally open. Even though some of the companies involved in FLOSS manage to capitalize on their projects, the importance of being open over being free is greater. Thus “to foster cumulative innovation it is important that former knowledge and innovation are easily accessible for everybody under conditions that are not too difficult to meet and not discriminatory. They must remain open, but not necessarily free of charge, if the price of access is reasonable”[5].

If you are not familiar with the FLOSS operations, I will emphasize on the story of Red Hat, the world's most successful open source provider. Red Hat products are paid for and enterprise targeted, but they are also open source and have free variants too. The paid for product is called Red Hat Enterprise Linux (but is open source and has its code freely available) and has several versions for server, desktop and cloud, but the same company (Red Hat) offer Fedora Linux, which is a community driven project that offer best in class, leading edge software solutions that are completely open source and free as in no cost. Besides this project, there is CentOS (Community Enterprise OS) that is a free rebuild of Red Hat Enterprise Linux (RHEL) and is free of charge and open source too. Based on CentOS and RHEL you can also find Oracle Linux, developed by Oracle and Scientific Linux that is developed by the scientists at CERN. Even though you can use those products free of charge and they are open source, the Red Hat as a company is the first company that managed to pass the 2.5 billion dollars revenue mark this year [6]. And remember, we are talking about open source software. This is a huge deal, and this is placing the company among the top companies in the world in terms of income and revenue values. Contrary to Red Hat's approach, other important projects among FLOSS such as Debian, are not concentrated on making profit, but more on creating an healthy open source ecosystem on which other projects can thrive, without being governed by a commercial entity. Their model is an example of meritocratic organisation based on clear and transparent democratic rules that govern the open source and free paradigms.

In this respect, Julien Penin stated that “open innovation must encompass three constitutive elements: (I) voluntary knowledge disclosure from <<participants>>; (II) knowledge being open; and (III) continuous and dynamic interactions among <<participants>>”[7]. Now, those participants must rely on two basic levels of innovation: hardware and software. Mainly, the second level is the most important one, as any hardware can be useless without specialized software that make it work the way it was intended at first. Nevertheless, the hardware part is equally important, as this is the part where ingenuity in design and engineering is actually running the innovation process.

This is where the open source appropriate technology (OSAT) comes into place. Now, let us elaborate more on this and see what OSAT is. “OSAT refers to, on the one hand, technology designed with special consideration to the environmental, ethical, cultural, social, political, and economic aspects of the community it is intended for. On the other hand, OSAT is developed in the open and licensed in such a way as to allow their designs to be used, modified and distributed freely” [8]. OSAT is the missing link between rural development and open innovation, as it creates a new paradigm of an open knowledge ecosystem based on contributing ideas, designs and code. OSAT is the one that links open source hardware as described in the previous article on this matter and the cultural landscape development through open innovation. OSAT refers to local maker communities that are the motors for local economies. Those communities are comprised of both producers and consumers. Most of the activities are achieved by service learning, which is “an educational approach that combines learning objectives with community service in order to provide a pragmatic, progressive learning experience while meeting societal needs” [9]. To be more specific, types of service learning are more known as volunteering, community service, internships or field education.



The community involvement is also the motor for diverse spatial outcomes in urban and rural areas, thus defining the degrees of openness of a particular area. Saskia Sassen refer to this “as the incompleteness of cities, which means that they can constantly be remade, for better or for worse” [10] Thus, to be complete, an urban or rural entity can appeal to open source tools to create a better environment, one that is desired by the community not only by the powerful stakeholders or actors that are looking for profit.

Open source tools are the ones that can become the main assets of cultural landscape (re)modelling in rural areas. In this respect, I would like to emphasize on several important projects that are based on the open source culture. First, there is **Appropedia**, a collaborative work on sustainability, appropriate technology, poverty reduction and permaculture [11]. Secondly, there is the **WikiHouse** project, an “open source project to reinvent the way we make homes. It is being developed by architects, designers, engineers, inventors, manufacturers and builders, collaborating to develop the best, simplest, most sustainable, high-performance building technologies, which anyone can use and improve” [12].

Those projects are cornerstones in open source innovation, the ones that are meant to shift the way innovation is going to become a part of any local community strategy’s involved in the development of the rural areas. Furthermore, each community needs to borrow some practices that only large scale companies use to innovate. In this respect, each community must have both, a culture of innovation – meaning that they are willing to always bring something new to their participants, and a well thought infrastructure of innovation – meaning that they are able to create the necessary systems to link people and technology to their participants’ needs [13]. More, each community of creators must be open to experimentation. None should be scared by this innate aspect of innovation. Everett Harper stated that “testing a prototype in the market, creating a new business model, or learning new automation might reveal that the <<real>> innovation is in the process not the product” [14]. This is true for rural community development too.

Now, going from Appropedia and WikiHouse, I must also say something about another open source hardware project, the **XYZ Spaceframe** vehicles [15]. This project features unique designs for small vehicles designated for persons or goods transportation. There is also the open source hardware called **Global Village Construction Set (GVCS)** developed by the Open Source Ecology team, which is a modular low-cost platform that allows the applicants to create over fifty mechanical structure that would support a sustainable living (discussed in the previous TE-RE-RD paper) and can be used to develop the local cultural landscapes [16].

Another cornerstone project is the **FarmBot**, an open source farming machine that is used to grow food by a large number of people, and it has also been used to create an open source innovative production system for NASA [17]. Even though the FarmBot machines are not free (they cost more than \$3000) their schematics are freely available online, thus one can 3D print all the components or even try to buy them separately online. Similar to FarmBot, there is **FarmHack**, a worldwide community of farmers that use open source tools for their farming [18]. They also produced their own “operating system”, called **farmOS** [19]. It is a web-based application based on Drupal, which is an open source content management system used and developed by millions of individuals (myself included).

Closely related to the open source actions, we must tackle the planning process too, because this is the part which almost everybody hates [20], starting from the professionals down (or up) to the community members. The first ones hate the system that is too bureaucratic and highly politicised, and the others hate it because, as Alastair Parvin said, “the system seems to be locked into a Faustian pact with speculative property developers – large companies building poor quality, unaffordable homes for considerable profit” [21]. Thus, what are the solutions at hand?

## 2. CONCLUSIONS

First of all, we need to involve the communities, alongside professionals, into creating the new infrastructure for innovation at the local and regional scale, in order to develop their cultural landscapes. This is a major aspect, as nobody knows the local cultural landscapes better than the local communities do. To be able to do this, knowledge assimilation is an important aspect, and the open source aspect is playing a major role. Being free and open source, this type of knowledge is the foundation of open innovation and local cultural landscapes development.

For example, picture how local rural community would thrive by using free and open source tools, like the ones used for creating the WikiHouse or the XYZ Bike, the FarmBot or FarmHack. It would be a great thing to see, but knowledge is the main player here, as the local rural communities lack the knowledge needed to use those open source tools. Imagine a local farmer from Romania do a C/C++ or Python script for the FarmBot, for example. It is unimaginable actually. Nevertheless, this is a great way to create local community groups that can fight the young people migration from rural to the urban areas. We could create some Special Interest Groups (SIGs) that can bring knowledge through local manufacturing courses and even low level software development for the young ones. Knowing that all young children do programming in high school (mostly C and C++) this could be a great way to motivate them stay into their local rural communities and help developing them through open source solutions and tools. Another beneficial output would consist in the opportunity for the young ones to learn about open source and thus start using this type of tools from an early age. This will certainly shape the way they will look at software and hardware assets from then on.

Another positive outcome from this kind of approach would be the way young citizens will perceive the planning process. Thus, the community involvement in the local cultural landscape development will improve the overall user experience with regard to the local processes. In this respect, for example, there is an Open Planning initiative in the UK, where local councils and members of the local communities help developing a smartphone app that would help citizens view ongoing or proposed planning applications on a map, allowing users to find detailed information about every planning project that is taking place in their areas.

Thus, local communities become incubators and accelerators of innovation. Being open, it is a greater thing, as they will foster a healthy local development using local material and immaterial resources to contribute to the cultural landscape's equilibrium.

Thus, the relations between the cultural landscapes, open source hardware/software and open innovation are clearly generated by the efficient use of resources and the production of knowledge. The way and scale those two are leveraged will determine the level of innovation achieved. In this respect, I constantly advice my students enrolled in my Cultural Landscapes and Development course to see the cultural landscapes as infinite sources of knowledge production and (re)generation, and that all the answers for a local development lay inside the area to be developed. Starting from local materials, workforce and ultimately, knowledge. Moreover, as the World Heritage Convention states, the cultural landscapes "are the combined works of nature and of man" and that they "often reflect specific techniques of sustainable land-use, considering the characteristics and limits of the natural environment they are established in, and a specific spiritual relation to nature" [22]. Now, those techniques can easily be seen as open source generated, specific to the 21<sup>st</sup> Century, and the spiritual relation to nature is thus more likely to be present for the local population/community rather than to an outsider trying to develop some for-profit project.

## References

- [1a] <https://www.linuxfoundation.org/blog/the-10-most-important-open-source-projects-of-2011/>
- [1b] <https://hackernoon.com/top-6-open-source-projects-in-2017-db34b9d034a2>
- [2] Chesbrough, H., Open Innovation: The new imperative for creating and profiting from technology. Boston: Harvard Business School Press, 2003, p.43.
- [3] [https://www.theregister.co.uk/2017/02/15/think\\_different\\_shut\\_up\\_and\\_work\\_harder\\_says\\_linus\\_torvalds/](https://www.theregister.co.uk/2017/02/15/think_different_shut_up_and_work_harder_says_linus_torvalds/)
- [4] Penin, J., More open than open innovation? Rethinking the concept of openness in innovation studies, BETA UMR 7522, Document de Travail no. 2008 – 18, p.2.
- [5] Penin, J., More open than open innovation? Rethinking the concept of openness in innovation studies, BETA UMR 7522, Document de Travail no. 2008 – 18, p.6.
- [6] <https://www.redhat.com/en/about/press-releases/red-hat-reports-third-quarter-results-fiscal-year-2018>.
- [7] Penin, J., More open than open innovation? Rethinking the concept of openness in innovation studies, BETA UMR 7522, Document de Travail no. 2008 – 18, p.8.
- [8] [https://en.wikipedia.org/wiki/Open\\_source\\_appropriate\\_technology](https://en.wikipedia.org/wiki/Open_source_appropriate_technology).
- [9] <https://en.wikipedia.org/wiki/Service-learning>.
- [10] <https://www.domusweb.it/en/opinion/2011/06/29/open-source-urbanism.html>.
- [11] [http://www.appropedia.org/Welcome\\_to\\_Appropedia](http://www.appropedia.org/Welcome_to_Appropedia).
- [12] <https://wikihouse.cc/about>
- [13] <https://www.forbes.com/sites/everettharper/2018/04/16/a-culture-of-innovation-is-not-enough/#7ffe396a3baa>
- [14] <https://www.forbes.com/sites/everettharper/2018/04/16/a-culture-of-innovation-is-not-enough/2/>
- [15] <http://www.n55.dk/manuals/spaceframevehicles/spaceframevehicles.html>
- [16] <https://www.opensourceecology.org/gvcs/>
- [17] <https://farm.bot/>
- [18] <http://farmhack.org/tools>
- [19] <http://farmos.org/>
- [20] <https://medium.com/wikihouse-stories/the-future-of-planning-98b3b7a53e9a>
- [21] ibidem
- [22] <https://whc.unesco.org/en/culturallandscape/>

# ENVIRONMENTAL PROTECTION IN FOOD INDUSTRY THROUGH FOOD WASTE CONTROL

Cristina Maria Canja<sup>1</sup>, Adriana Elena Boeriu<sup>2</sup>, Adrian Măzărel<sup>3</sup>  
Transilvania University of Braşov, Romania  
Department for Engineering and Management in Food and Tourism

## ABSTRACT

The close link between the food industry and the environment can be analyzed for a double purpose. Thus, taking into account the point of view of the resources of raw materials and auxiliaries that the food industry processes, the environment, through its components - soil, water, climate is the one that greatly influences its success rate. From the other point of view, the food industry through the waste it generates daily, through the use of technological waters, food products created and not sold in a timely manner, food waste of the population or public food is one of the worst sectors of the industry.

In this context, the present study aims to measure the main ways in which the environment naturally supports the food industry, as well as the measures and means that are recommended to be used by all players involved in the food chain to conserve and reevaluate good environmental conditions.

**Key words:** waste of food, environmental protection, food chain, food industry.

## 1. INTRODUCTION

The food industry is one of the most dynamic and important industries in Europe, being also the main industrial area through the European Union.

Analyzing the previous decade, most European countries have not subjected the food industry to environmental legislation, with regard to emissions that have been considered to be relatively favorable, compared to many other industrial sectors. The main target of this industry is focused towards enhancing environmental performance by maximizing the use of raw and auxiliary materials, industrial byproducts, solutions that subsequently lead to minimizing the amount of waste that causes pollution.

The food industry's mission is to provide consumers with safe, quantitative and high-quality food. To the same extent, the food industry is indebted to its consumers to assess and correct the effects they exert on environmental factors. Therefore, all food producers, regardless of production size, geographical location or technological stage: from primary production to the marketing stage and to the last consumer, should consider and apply the highest food safety standards, in compliance with the rules concerning legal environment protection.

Food industry is supervised by compressive and very detailed legislation related to the food chain, being under pressure not only in terms of food safety, but also in enhancing environmental performance.

A series of "clean and friendly" technologies for food processing have been developed precisely to enable producers to better understand the effects of their activities on the environment and to adopt practical measures to achieve sustainable production.

---

<sup>1</sup>Braşov, 148, Castle Street, email: canja.c@unitbv.ro

From a technological point of view, the food industry faces two major problems related to environmental protection - energy management and waste management.

Food industry is a great energy consumer for technological processes and, in the same time, being a large waste generator: waste derived from production processes, food products and residues of food products dumped as solid municipal waste, packaging.

## **2. THE ENVIRONMENT – SUPPORT FOR FOOD INDUSTRY**

The environment, through all its elements, is a direct and indispensable support to the food industry to develop and produce safe and healthy food for consumers.

Agriculture constitutes the leading supplier of raw materials for the food industry, its results being influenced to a great extent by the quality of soil, water and air. In this context, the responsibility of the food industry and all those involved in the food chain is increasing in terms of measures and actions taken to environmental protection.

**Soil.** Soil is the component of the environment that supports the food industry concerning the raw materials of vegetable origin (cereals, vegetables, fruits, etc.) that can be both sources of food for the population and animals.

**Water.** Water represents an indispensable element for life, representing an important factor for almost all the industrial production processes.

In the food industry, water has multiple uses in the technological process such as: raw or auxiliary material; washing water; sorting water; water cooling and transport of various materials.

The water used in technological processes in the food industry must correspond to features that ensure adequate food quality, be of drinking and have appropriate organoleptic characteristics. The taste and smell of water depend on chemical composition, temperature and the presence of volatile substances.

**Air.** Air contamination can be highlighted by two physical aspects of atmospheric pollution: solid or liquid (aerosol) active chemical or biological particles, molecules transmitted by gas chemical pollution. These contamination, which presents a wide variety of aspects, nature, behaviors and effects, have a common characteristic: they are all invisible to the naked eye (excepting the particles in enormous concentrations such as colonies or smoke). This invisibility is the main cause of inappropriate perception of the dangers that may arise due to these contamination. Thus, the basic hygiene rules (hand washing, use of masks when necessary) or the use of more complex measures (filtration, white halls, isolated spaces) are often not respected.

The air contains a large number of substances that come from natural processes, erosion, wind, sea evaporation, earthquakes, volcanic eruptions. To the extra elements are added particles of anthropogenic origin, which come from industrial combustion products, powders from nuclear exploitations, forest fires, engine exhausts, etc.

## **3. SOURCES OF ENVIRONMENTAL POLLUTION IN FOOD INDUSTRY**

As shown in the introduction of this study, environmental pollution in food industry is due to the large amount of waste it generates. One of the waste generators is the weak management of technological processes, technological processes that generate significant amounts of waste through waste and waste of materials, leakage, defective products or inadequate design.

### **3.1. Surplus of materials**

When we talk about the excess of materials in most cases we refer to the hard-appreciated dimensions of the materials for food packaging even with the best operating equipment for accurately approximating the overplus of materials, the packaging of products will inevitably exceed the limits imposed by the product that is intended to be packed. Due to its economic significance, the surplus is monitored by mass control devices, either continuously or staggered.

### **3.2. Waste of raw materials and materials**

The waste of products results from the inadequacy of products for human consumption and is considered to be loss or waste. Repeated generation of loss during production indicates an inadequate process or defective machine maintenance.

### **3.3. Drainage of liquids**

A large number of equipment used in food industry is working on leaking liquids, which can be an important source of waste material, a source of loss if it is not properly recovered.

### **3.4. Faulty products - returned products**

Products that do not meet the qualitative specifications imposed by the rules in force, whether or not they have been shipped or returned from marketing, may constitute a major source of material or waste if they are not properly recovered or annihilated. Also included in this group are products that have exceeded their shelf life.

### **3.5. Inappropriate design losses**

Some process equipment, even with modern technology, can cause material and waste losses due to inappropriate design.

## **4. FOOD WASTE**

The waste of food has reached such an important dimension that it can be considered a global problem that has repercussions on all links in the food supply chain, from field to consumer. According to data recorded since 1974 to date, it is estimated that global food waste has increased by 50%. Waste of food is recorded in agricultural fields, processing industry, distribution companies and consumer housing; food is wasted in industrialized countries and developing countries. Food waste gives rise to a parallel field to the production line and generates a long series of negative effects. The issue of food waste is opposed to the fundamental problem of food supply, which is severely compromised by a number of factors, including limited natural resources in relation to the growing population of the world and low access to food of the poorest population groups. This results in a series of analyzes and reflections on how we use the foods at our disposal.

A recent FAO study highlights alarming data, especially with regard to the industrialized world: European and North American citizens waste each year between 95 and 115 kg of per capita food compared to sub-Saharan Africa, wasting between 6 and 11 kg. Causes of food waste are not always the same; they differ according to the stage of the food supply chain, the

type of product and the place where the food is wasted. If the food chain is divided into five sectors (agricultural production, management, storage, processing, distribution and consumption), one can see how different behaviors in each sector lead to the elimination of perfectly edible food: starting with harvesting losses during harvesting and storage, to unsafe transport, labeling errors, and end-user habits when purchasing and using food.

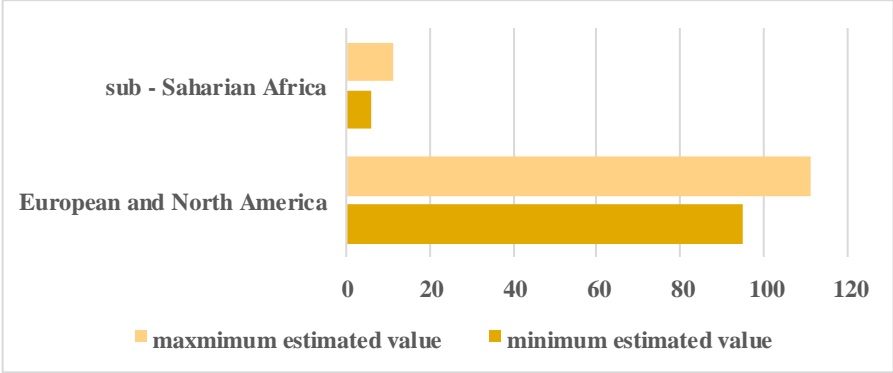

Fig. 1. Food waste compared Europe and North America and sub – Saharian Africa

As far as industrialized countries are concerned, most of the waste of food takes place in the final stages, that is to say in the distribution and consumption stages, in particular because of the overfunding of food products, while in developing countries the waste of food is mainly taking place in the early stages due to the lack of advanced agricultural technologies, efficient transport systems and infrastructure (for example continuous keeping at a low temperature) and the possibility of safe food storage. These data highlight the fact that currently produced food can in fact be reused for food purposes instead of being disposed of as waste, which has ecologically and economically significant effects and generates ethical implications.

Combating food wastage must become a priority on the European political agenda, the Commission, the Council and the Member States must create concrete strategies and measures to divide in half until 2025 the quantity of food that is wasted throughout the supply chain, increase the efficiency of industry and raise public awareness of a topic ignored in many ways. Citizens need to be informed not only about the causes and consequences of food waste but also about ways in which it can be reduced; a scientific and civic culture based on the principles of sustainability and solidarity must be promoted in order to encourage more virtuous conduct. Experience has shown that spontaneous initiatives by associations, whether voluntary or professional, to promote and implement a culture to combat food waste, have been a significant success in the areas where they have taken place.

Food waste involves environmental and ethical issues as well as economic and social costs that create challenges for the internal market for both businesses and consumers. It is also emphasized the need for a political agreement to find solutions to food waste; urges the Commission, as part of the European political agenda, to give priority to all aspects of food waste; calls on the Commission, in consultation with the Member States, to set targets for reducing food waste; calls on the Member States and all stakeholders to take practical steps to meet these objectives.

Food waste is responsible for generation of about 170 Mt of CO<sub>2</sub> eq. in the EU each year. In order to assess all the environmental benefits of food waste reduction initiatives, one must consider not only the fact that food waste treatment is reduced but that the food processing and other upstream steps of the life cycle are avoided too.

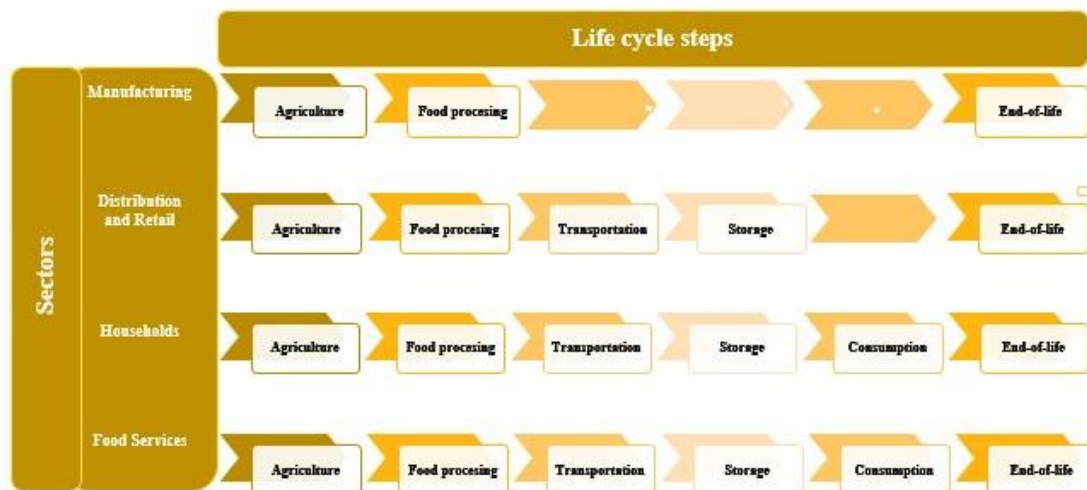

Fig. 2. Life cycle considered for each sector

For that reason, the environmental impacts of the life cycle of food waste were quantified, not only those linked to the treatment of food waste, but also those generated during the other steps of the life cycle before they become waste. A life cycle approach was used. Without carrying out new life cycle analysis (LCA), the approach focused on identifying available research and extracting data from which extrapolations could be made using the findings of this study. The results are presented for each of the four sectors considered in this study. The system boundaries for each of them are summarised in the figure below. It should be noted that while agricultural food waste is outside of the scope of this study, the environmental impacts of agriculture in the food supply chain were nevertheless taken into account when assessing the life cycle environmental impacts of food waste generated by the four relevant sectors (see diagram below).

The studies conducted by the national associations such as Romanian Consumer Protection, InfoCons and the Association of the Great Commercial Networks in Romania - AMRCR have highlighted the causes that lead to waste of food. Thus, fast degradation of food (26%), erroneous estimation of the quantities of food consumed for a meal (21%) and excess purchases (14%) are the first.

The same study highlights the ranking of the most wasted foods - the first place being covered by cooked meals (25%), followed by bread and pastries (21%), vegetables (19%) and fruits (16%).

The approach of food waste worsens considerably, urgent measures are needed to be in line with what is being done in the context of a national strategy to tackle the risk of food and waste management. The necessary measures are aimed at the next, as well as the near or distant future and target all sectors of the food industry, the entire food chain, public catering services and final consumers. Legislative measures in the field must be designed to prevent food waste from being passed on to household consumers or the industrial environment.

## 5. CONCLUSION

Environmental protection means efficient resource management, avoiding imbalances by preserving nature, avoiding environmental pollution. Environmental protection measures have



one purpose - to maintain the ecological balance in order to ensure better living and working conditions for future generations. In the same context, the food industry is also closely related to environmental protection as a resource for the environment, as well as its major pollutant.

Statistics say global food waste is over 750 billion dollars, which is six times higher than the one used to help people living in poverty worldwide. From the strict environmental point of view, food waste is responsible for producing 45% of greenhouse gas emissions. By way of comparison, global air traffic emissions represent about half of the greenhouse gas emissions generated by food waste.

## References

- [1] Ministry of Agriculture and Rural Development, [http://www.madr.ro/docs/ind-alimentara/risipa\\_alimentara/bio\\_foodwaste\\_report.pdf](http://www.madr.ro/docs/ind-alimentara/risipa_alimentara/bio_foodwaste_report.pdf).
- [2] Ministry of Agriculture and Rural Development, [http://www.madr.ro/docs/ind-alimentara/risipa\\_alimentara/UNEP-FW-Guidance-Prevention-and-reduction-food-waste.pdf](http://www.madr.ro/docs/ind-alimentara/risipa_alimentara/UNEP-FW-Guidance-Prevention-and-reduction-food-waste.pdf).
- [3] Ministry of Agriculture and Rural Development, [http://www.madr.ro/docs/ind-alimentara/risipa\\_alimentara/trebuie-sa-spunem-STOP-risipei-de-alimente.pdf](http://www.madr.ro/docs/ind-alimentara/risipa_alimentara/trebuie-sa-spunem-STOP-risipei-de-alimente.pdf).
- [4] Waldron, K., „*Handbook of waste management and co-product recovery in food processing. Volume 1.*”, CRC Press, England, 2007.
- [5] Waldron, K., „*Handbook of waste management and co-product recovery in food processing. Volume 2.*”, CRC Press, England, 2007.
- [6] Hung Y. T., „*Handbook of Environment & Waste Management. Volume 2.*”, World Scientific, London, 2012.
- [7] Lawrence K. Wang, Yung-Tse Hung, Howard H. Lo, Constantine Yapijaki, „*Waste Treatment in the Food Processing Industry*”, Taylor & Francis, London, 2013.
- [8] Vasso Oreopoulou, Winfried Russ, „*Utilization of By-Products and Treatment of Waste in the Food Industry*”, Springer, Greece, 2007.
- [9] Maria Kosseva, Colin Webb, „*Food Industry Wastes: Assessment and Recuperation of Commodities*”, Elsevier, London, 2013.
- [10] Ioannis S. Arvanitoyannis, „*Waste Management for the Food Industries*”, Elsevier, London, 2008.

# ASPECTS ON THE WORKING PROCESS OF THE CEMENT MILLS AND DIMENSIONAL CHARACTERISTICS OF THE RAW MATERIAL

Cristian CIOBANU<sup>a</sup>, Gheorghe VOICU<sup>b1</sup>, Magdalena–Laura TOMA<sup>b</sup>, Paula TUDOR<sup>b</sup>  
<sup>a</sup> CEPROCIM Bucharest, <sup>b</sup> POLITEHNICA University of Bucharest

## ABSTRACT

In essence, this paper presents some aspects regarding the technological process of grinding of the Portland cement components and the working process of ball tubular mills, including its component parts. The particle size distribution for clinker, limestone and gypsum, which are the basic components of the cement determined on the flow of a cement plant in Romania, is presented and their regression analysis is done, with known distribution functions in order to estimate the average particle size of the mixture subject to grinding.

**Keywords:** cement mill, raw material, particle size distribution

## 1. INTRODUCTION

Cement is obtained by crushing together clinker and admixtures (gypsum, limestone, slag etc.). Grinding of the clinker and additives is generally performed in a tubular ball mill operated in closed circuit divided into two rooms.

Cement clinker is a compact material with a porosity of less than 8% and is very rough. It is obtained by combustion of raw materials (a mixture of limestone 75 – 77% and 23 – 25% clay) at the temperature of 1450 – 1500°C, [1, 4 – 7].

The clinker and the crushed admixtures, deposited in silos or feeding hoppers of the cement mill, are extracted and gravimetrically dosed (depending on the type of cement that is desired to be obtained). The sum of all these quantities gives the wet productivity of the mill. Knowing the humidity of the feedstock mixture (determined in the laboratory), dry productivity is calculated. The dosing components are taken up by conveyor belt relays and then discharged onto the collector belt feeding the cement mill. At the mill exit, the material is picked up by a pneumatic gutter and transported to a vertical elevator, which through another pneumatic gutter, feeds a dynamic separator, where the separation of fine particles and coarse particles takes place. The fine fraction (cement) is further taken up in pneumatic gutters and transported to the cement silos via a conveyor belt relays (or other type of carrier). The coarse part (tail) returns to the mill to continue grinding and bringing the particles to fine size, [1 – 4].

The mill is continuously fed and operates in a closed circuit, the material that does not meet the particle size requirements of the cement returns to the mill.

The retention time of the material in the mill differs depending on the grinding ability of the materials entering the mill (how easily it is milled), the fineness of grinding (fineness of the finished product, cement).

## 2. METHODOLOGY

The principle flowchart for grinding components and obtaining Portland cement is shown in Figure 1.

---

<sup>1</sup>Splaiul Independentei 313, Sector 6, Bucharest, 0724715585, ghvoicu\_2005@yahoo.com

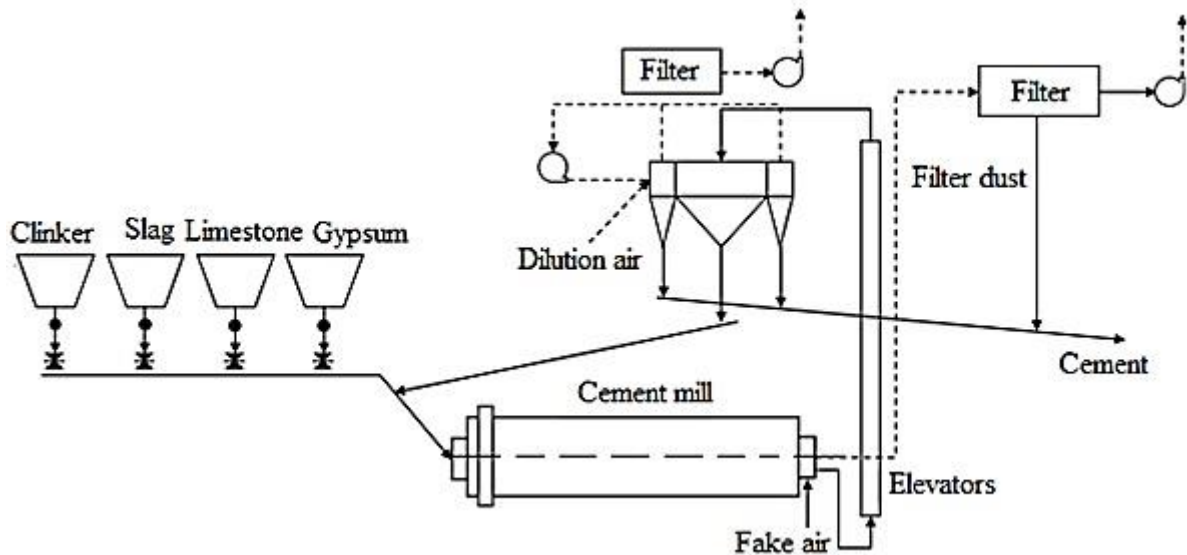

Figure 1: The flowchart of cement grinding [5, 6]

The tubular mill is loaded with about 30% milling bodies (steel or high alloy cast iron balls).

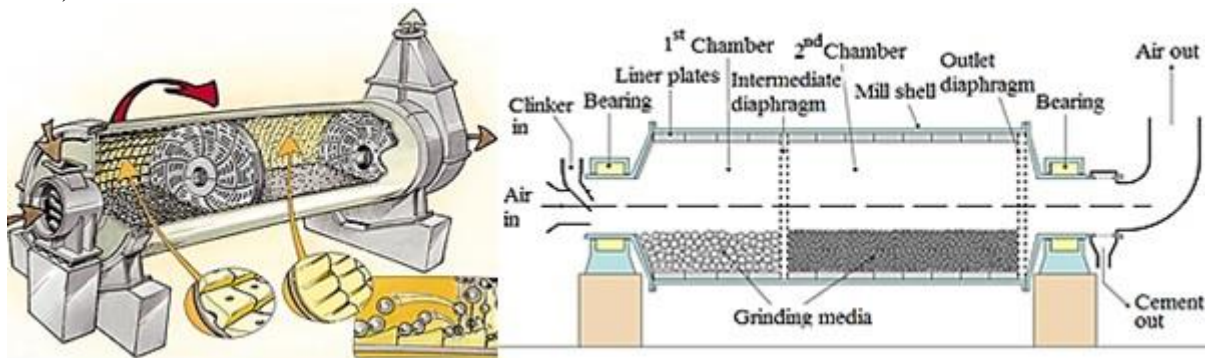

Figure 2: Diagram of a tubular ball mill for cement [5, 6]

Milling takes place as a result of the material particles being struck by the grinding bodies, with the armour (which lining inside the walls of the mill and are of several types) or between them (autogenous grinding) following the rotation of the mill. The grinding of cement mix is a high-energy operation. In order to reduce the particle size from 30 mm to 3 mm, an average energy of 2 kWh/t is consumed, for crushing from 3 mm to 0.3 mm it is consumed about 6 kWh/t, in exchange for crushing from 0.3 mm to 0.03 mm and a specific surface about 3500 cm<sup>2</sup>/g it is consumed approximately 24 kWh/t, [1 – 5].

Tubular mills are generally equipped with sensors (of various types) that indicate the degree of filling in each room. Depending on their indications and the amount of tail that is returned to the mill, the amount of clinker and fresh feed to feed the mill is determined. The discharge of the grinder from the inside of the mill is made by means of a stream of air flowing over the load, the optimum speed being between 1.4 - 2.2 m/s. Ventilation of the mill is also necessary for its de-dusting and cooling. During grinding, the temperature of the materials and the friction between the bodies in the mill cause the temperature to rise inside. A too high temperature damages the quality of the finished product (undesirable chemical changes may occur) and can even lead to mechanical defects of the mill (through excessive bearing and roller temperature). The temperature from the mill evacuation should be within 90 – 110°C for proper dehydration of the gypsum, [1 – 5].

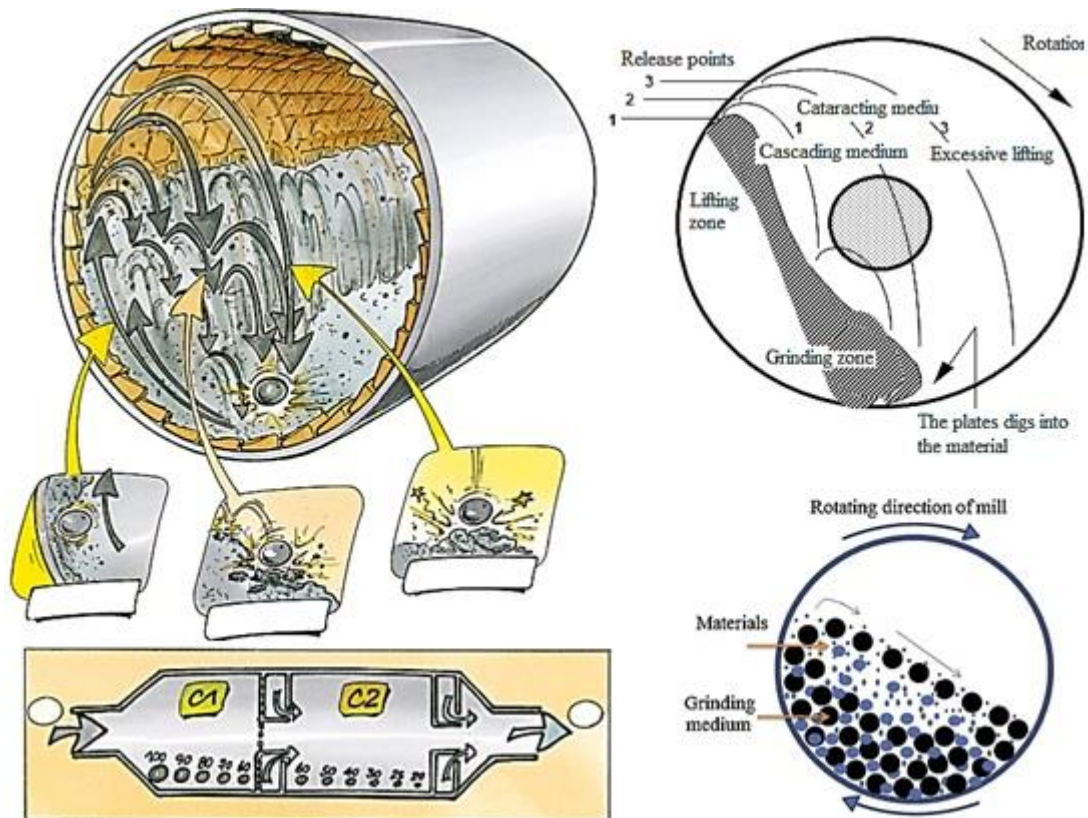

Figure 3: The working principle of tubular ball mill for cement [5, 6]

The partition wall between the two rooms and the wall at the exit of the mill are provided with slots of different dimensions. The milled material, which has reached the corresponding granulometric dimensions, passes from one room to another and leaves the mill through these slots and through the ventilation ring. Material samples are taken manually or automatically from/off conveyors (pneumatic gutters/conveyor belts). They will be manually removed only after stopping the grinding flow and under specific conditions with regard to health and work safety.

At the mill exit, material does not comply with required grinding fineness (grinding is not complete), it is necessary to separate the fine particles from the coarse ones. This is done with the help of a second-generation dynamic separator.

The tail is the coarse part of the material at the separator exit. The flour is the finest part of the material at the separator exit, in this case, the finished product, i.e. cement. The left and right gutters are pneumatic conveyors, named after their position (to the left or right of the separator). The particle size analysis for the material fed into the mill is made by passing it onto a series of screens and meshes of different sizes and making calculations that take into account the quantity that passes and that which remains on the screen.

Particle size analysis of material exiting the mill is made either by passing it on a sieve classifier or by using particle size gauges based on laser granulometry. Laser diffraction is widely used as a particle size analysis technique for materials ranging from several hundreds of nanometres to several millimetres.

The temperature of the material is measured manually or automatically using contact thermometers or various distance measuring devices (pyrometers). The temperature of the material at mill exit and the temperature of the cement are usually measured.

For various studies, technological audits, etc., the temperature can also be measured in other points (e.g. the exit gutters of the cement or the tail, the classifier feeding gutter, the material fed into the mill).

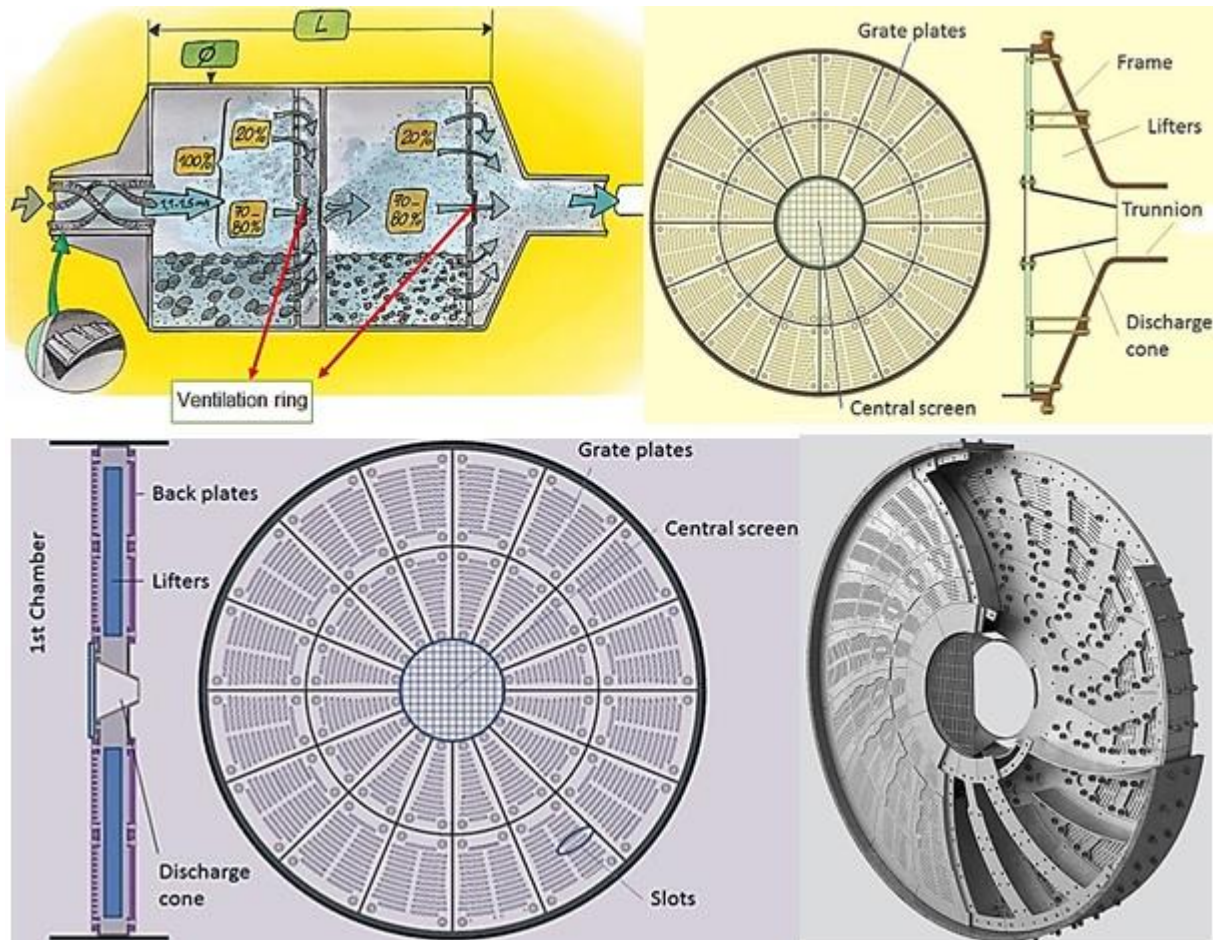

Figure 4. The principle schemes of the ball mill diaphragms (partitions) [5, 6]

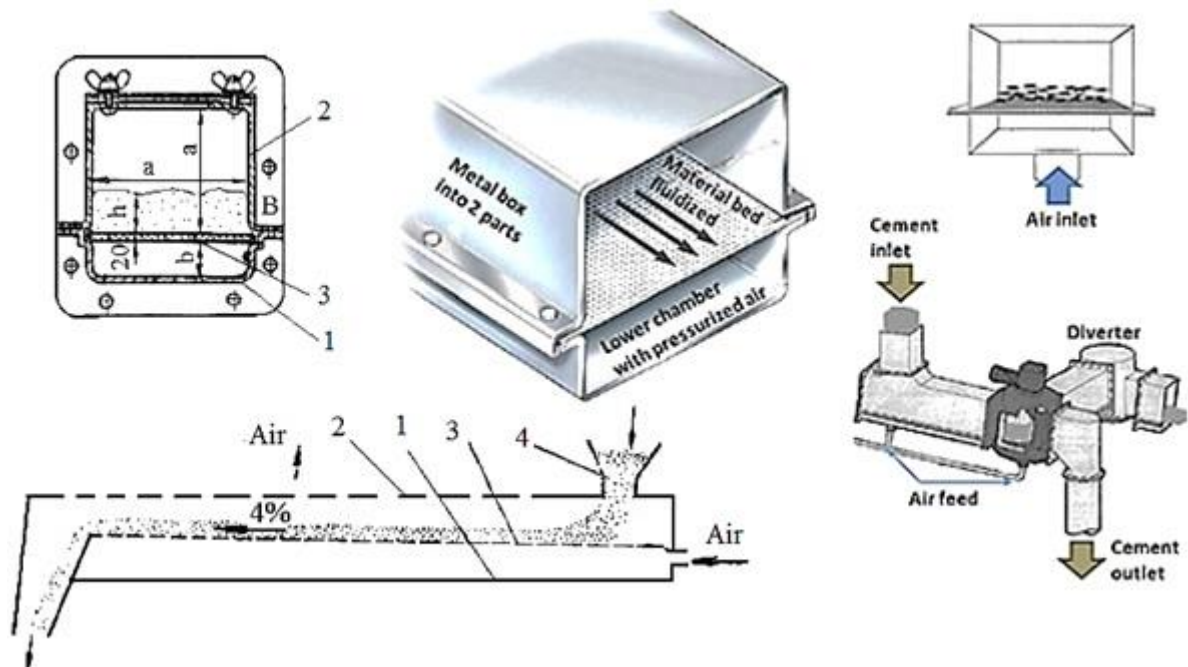

Figure 5. The schematic diagram of the pneumatic gutter [5]

1 – lower chamber; 2 – upper chamber; 3 – porous membrane fabric; 4 – feeder

Experimental results on particle size distribution of grinding material can be tested by regression analysis using the Andreason & Andersen distribution law (modified), [3]:

$$P(D_i) = 100 \cdot \frac{(D_{max}^n - D_i^n)}{(D_{max}^n - D_{min}^n)} \quad (1)$$

where:  $D_i$  is the current particle size of the material;  $D_{min}$ ,  $D_{max}$  – the minimum and maximum dimensions of the particulate material;  $n$  – experimentally determined exponent.

For an amount of material equal to the unit, if particle is considered as spherical of diameter  $d$  and if the intrinsic density of the material  $\rho$  is known, the specific surface area of a powder mixture of particles can be determined by calculation as follows:

$$S_s = m \cdot s_1 = \frac{1}{\frac{\pi d^3}{6} \rho} \pi d^2 = \frac{6}{d \cdot \rho} \quad d = \frac{6}{S_s \rho} \quad (2)$$

### 3. RESULTS

To determine the characteristics of the material being ground and obtaining Portland cement determinations were made at one of the cement factories in Romania during the 2017 audit. The results for the size distribution are shown in Table 1.

Table 1. Particle size distribution for cement components and raw mixture

Sieve holes size, mm	40	30	25	15	10	7	5	3	1	0	
Fraction, %	Clinker	1.25	1.60	2.10	9.30	13.45	17.6	8.60	21.95	10.70	13.45
	Limestone	1.55	1.10	2.15	5.10	7.65	8.10	6.65	15.95	22.60	29.15
	Gypsum	8.10	8.25	9.45	13.80	10.95	9.35	5.80	12.15	8.90	13.25
	Mix	1.90	2.14	2.77	9.21	12.54	15.73	8.12	20.36	11.94	15.29

The variation curves for the material separated by sieves, as well as for the unseparated and the cumulative fractions were drawn based on the results presented (Figure 6).

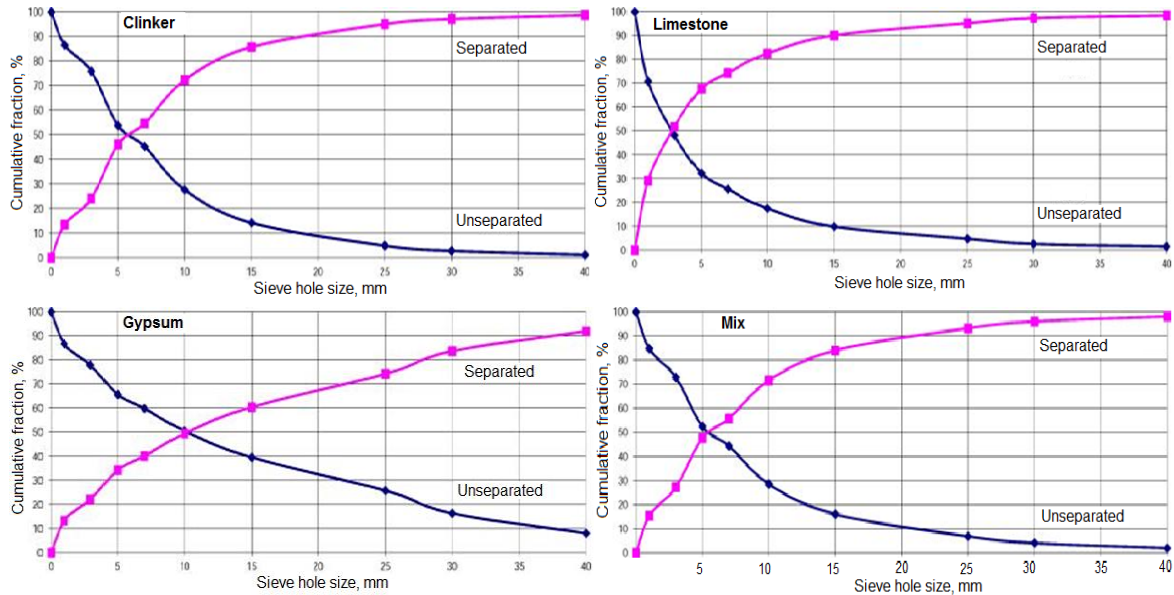

Figure 6. The particle size distribution of the components subjected to grinding for cement manufacture

The variation curves follow an exponential rate as can be seen from the analysis of the figure. Table 1 shows that maximum values on a 40 mm sieve were obtained for gypsum particles (8.15%), while the finest particles were obtained for the limestone component of the material mix (29.15% having dimensions below 1 mm). For the entire mixture, the calculated values for the fractions considered ranged between 1.90% over 40 mm and 20.36% for particles

between 3 and 5 mm. The percentages of cement manufacturing components were 75.89% clinker, 11.33% limestone, 8.66% gypsum and 4.12% furnace dust, only the first three were ground. After milling, at the mill exit, the material had the following characteristics:  $R_{90\mu\text{m}} = 17.36\%$  (recommended value of about 25%),  $R_{200\mu\text{m}} = 0\%$  and Blaine specific surface area (SSB) was  $3174 \text{ cm}^2/\text{g}$ . The mill power consumption was 32.6 kWh/t, and the separator recirculation rate of 1.57 (the ratio between the separator feed rate and the tail return flow to the mill). After separation in the separator and mixing with the filter dust, the final cement exhibited  $\text{SSB} = 4776 \text{ cm}^2/\text{g}$  and  $R_{90\mu\text{m}} = 1.22\%$ .

Calculated as weighted media from the feed material, the mean particle size of the material had the following values: 8.45 mm for clinker, 6.02 mm for limestone and 15.39 mm for gypsum.

#### 4. CONCLUSIONS

The manufacture of cement is a high-energy consuming process, involving a proper dosing of the components according to the manufacturing recipe (clinker, slag and limestone, gypsum) and grinding them into tubular ball mills. In the final grind, which has to meet the requirements regarding the average particle size and the specific surface area, well-defined proportions of kiln dust is added as well as filter dust obtained during the grinding and separation process.

If the mill output, the grounded material has a Blaine surface area of  $3174 \text{ cm}^2/\text{g}$ , the final cement has a SSB of  $4776 \text{ cm}^2/\text{g}$ , the size of the cement is much smaller compared both to the material subjected to grinding and the ground material, because it is subjected to a separation operation and, in addition, a filter dust is added.

The manufacturing recipe should lead to the framing of the manufactured cement within the limits of Portland cement. Regarding the dimensions of the raw materials particles used in the manufacture of cement, they have been found to have average values of 6-15.5 mm, both for clinker and for limestone or gypsum.

The data presented in the paper may be useful to the experts, and other users of the tubular ball mills and designers of such machines.

#### Acknowledgement

The authors thank the management of the Fieni cement factory, Romania, where the audit activities, the observations and the experimental determinations took place, as well as to the independent accreditation and accreditation laboratory of CEPROCIM, Romania.

#### References

- [1]. Arvaniti, E.C., Juenger, M.C.G., Bernal, S.A., Duchesne, J., Courard, L., Leroy, S., Provis, J.L., Klemm, A., De Belie, N., *Determination of particle size, surface area, and shape of supplementary cementitious materials by different techniques*, Materials and Structures, vol. 48, iss. 11, pp. 3687 – 3701, 2015.
- [2]. Ferraris, C.F., Hackley, V.A., Aviles, A.I., Measurement of particle size distribution in portland cement powder: Analysis of ASTM round robin studies, Cement, Concrete and Aggregates, vol. 26, iss. 2, pp. 1 – 11, Paper ID CCA11920, 2004.
- [3]. Mehdipour, I., Khayat, K.H., *Effect of particle-size distribution and specific surface area of different binder systems on packing density and flow characteristics of cement paste*, Cement and Concrete Composites, vol. 78, pp. 120 – 131, 2017.
- [4]. Weibel, M., Mishra, R.K., *Comprehensive understanding of grinding aids*, ZKG International, vol.6, pp. 28 – 39, 2014.
- [5]. \*\*\* - [www.alibaba.com/product-detail/ball-pebble-grinding-mill-pebble-ball\\_60238322430.html](http://www.alibaba.com/product-detail/ball-pebble-grinding-mill-pebble-ball_60238322430.html)
- [6]. \*\*\* - [www.thecementgrindingoffice.com](http://www.thecementgrindingoffice.com), The Cement Grinding Office, 2012 – 2015
- [7]. Valic, M.I., Stepisnik, J., Gabrijelcic, M., Vuk, T., Rescic, L., Setting times measurements of portland cements with pulsed USWR method, Kovine, Zlitine, Tehnologije vol.33, no.1-2, pp.83-86, 1999.

# WASTEWATER TREATMENT BY FLOTATION USING MAGNETIC NANOMATERIALS

Covaliu Ileana - Cristina<sup>1</sup>, Bruneau Amandine<sup>2</sup>, Kermade Stevan<sup>2</sup>, Paraschiv Gigel<sup>1</sup>, Biriş Sorin Ştefan<sup>1</sup>, Moga Corina Ioana<sup>3</sup>, Gabriel Petrescu<sup>3</sup>, Matache Mihai Gabriel<sup>4</sup>, Filip Ilie<sup>5</sup>

<sup>1</sup> Department of Biotechnical Systems, University Politehnica of Bucharest, 313 Splaiul Independenței street, București, Romania

<sup>2</sup> Biomedical Engineering: Biology and Health Systems, ISTIA School of Engineering of the University of Angers, France

<sup>3</sup> SC DFR Systems SRL, 46 Drumul Taberei Street, ap. 23, Sector 6, Bucharest, Romania

<sup>4</sup> National Institute of Research-Development for Machines and Installations Designed to Agriculture and Food Industry, 6 Ion Ionescu de la Brad, Bucharest, Sector 1, Romania

<sup>5</sup> Department of Machine Elements and Tribology, Polytechnic University of Bucharest, 313 Spl. Independentei, 060042 Bucharest, Romania

## ABSTRACT

Industrial effluents contained a lot of pollutants like oil or suspended solids. However, lipids represent a large part of these industrial effluents. As a consequence, it's primordial to find ways to remove these pollutants from industrial wastewater. Flotation is a solution to deal with this problem. This method aims to improve the separation between pollutants and water and to facilitate the recovery of pollutants. The novelty of our study is presenting the potential of using magnetic nanomaterials for increasing the efficiency of wastewater treatment by flotation.

## 1. INTRODUCTION

Currently we find in industrial effluents, a very important quantity of lipids in the form of oil, fat and fatty acids. Further, lipids constitute one of the major types of organic matter found in municipal wastewater [1].

It is therefore important to implement a method capable of facilitating the elimination of these pollutants present in wastewater.

For this we can have recourse to dissolved air flotation which is an efficient method used in water treatment.

## 2. METHODOLOGY

This method is designed to treat industrial wastewater containing finely various suspended solids and oily compounds. The aim is to improve the separation of particles with a density very close to that of water. Flotation aerates the effluent, whereby air bubbles are attached to the suspended matter. Suspended solids, oil and grease are carried to the surface of the flotation tank by these air bubbles. This method increases the buoyancy of particles.

Thus, the particles float and rise to the surface from where they can be easily removed [2].

---

<sup>1</sup> Splaiul Independentei 313, Sector 6, Bucharest, [cristina\\_covaliu@yahoo.com](mailto:cristina_covaliu@yahoo.com), 0722791791



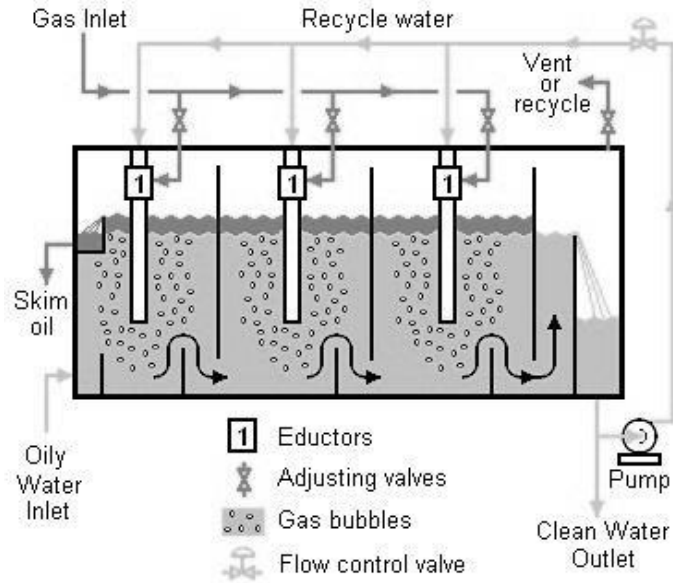

Figure 1: Schematic diagram of flotation [3]

As we can see on diagram from figure 1, the elimination of pollutants is obtained by introducing very small air bubbles into the wastewater. The bubbles adhere to oil and increase its buoyancy. This technique accelerates the speed at which the oil floats to the surface of the water and is then removed.

#### *Exiting approach*

##### 1) Dispersed-air flotation

Air bubbles are formed by introducing the air directly into the liquid phase. Then, the bubbles incorporate the suspended matter or oil. As a result of this fixation, the suspended matter/oil can float to the surface of the water where it will be removed by a skimming device. It is look like dissolved air flotation but the difference is the size of the bubbles which is larger. They have a diameter of about 1 mm which leads to the creation of turbulence that breaks down the particles [4].

##### 2) Dissolved air flotation

Dissolved air flotation (DAF) is a technique that can treat and clarify wastewater from oil refineries, chemical plants etc. DAF remove oil, grease, fats or total suspended solids. To make this remove, air is dissolving under pressure in wastewater. After that, this air is releasing at atmospheric pressure in a flotation tank. Bubbles take form by this released air and adhere to the suspended matter/oil. So, this suspended matter can float to the surface of the wastewater and will be remove by a skimming device. Here bubbles have a micron size.

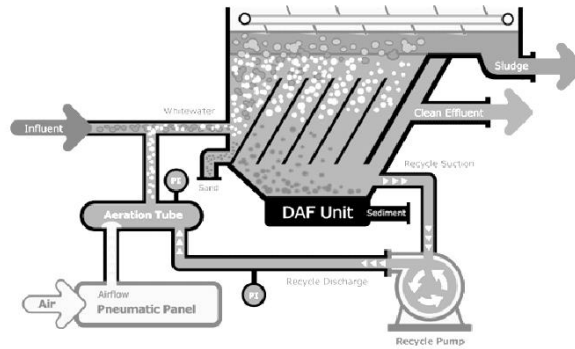

Figure 2: Dissolved air flotation systems [5]

To explain the system in figure 2 we will describe the five steps of the dissolved air flotation process [5].

- Influent water is put in the dissolved air flotation system. This influent is mixed with water which is supersaturated with dissolved air. The contact of these two waters allows the attachment between bubbles and solids particulates.
- Bubbles can push the suspended solids to the surface of the tank.
- A skimming device removes all the suspended solids at the surface.
- Still, some solids don't float and following down in the tank. These solids will be treated by an automatically controlled pneumatic drain valve.
- When the water is clarified, a part of this one flows out of the vessel and the other part is used for the recirculation.

In the dissolved air flotation, there exist three main types of processes [6]:

- Vacuum flotation: the water which is going to be treated, must be saturated with air at atmospheric pressure. Then, a vacuum is applied to the flotation tank permitting to release air in the form of small bubbles. This method is only used in the paper industry;
- Microflotation: in microflotation, the total volume of water must have an increased pressure. In the down-flow section, water is airted and the hydrostatic pressure increases so the quantity of air dissolved increases too. Then, when the water goes in the up section, the hydrostatic pressure is falling down and a part of the air dissolved is released in the form of fine air bubbles;
- Pressure flotation: in this technique, air dissolved in water under pressure.

However, the dissolved air flotation is better than the dispersed air flotation because the bubbles are smaller, so the contact surface is larger and allowed a better efficiency of the flotation.

The surface properties of a pollutant determine its ability to float. However, the degree of removal of suspended particles from wastewater can be improved by the addition of chemical additives. These elements are used to modify the surface properties of pollutants by making them more hydrophobic. This improves air bubble fixation [7].

There are three types of adjuvants: nonionic (example hydrocarbon oils), anionic and cationic (consist of a polar component that selectively attaches to pollutant surfaces and a non-polar component that makes the surface hydrophobic). The most used are anionic polymers.

Finally, aluminum and ferric salts or polymer coagulant are chemical coagulants added to improve the efficiency of the flotation process [2].

Regarding the wastewater treatment by flotation using magnetic nanomaterials we have tested the copper ferrite nanomaterial for removal of oil [8]. The investigation was done with and without copper ferrite nanomaterials and were observed the following advantages:

- The decreasing of time needed for wastewater treatment when the copper ferrite particles were utilized in the flotation process;
- The increasing of stability of the formed foam when were used copper ferrite nanoparticles in the flotation process which is important for the large-scale wastewater treatment processes when is required sufficient time to remove the foam having the pollutant on the surface of wastewater;
- A wastewater efficiency treatment of 100 % only in the testes in which was used copper ferrite nanomaterial.

### 3. CONCLUSIONS

Flotation technology is an effective method for removing pollutants. There are two methods used, dispersed-air flotation and dissolved air flotation with a similar operation. However, the second method is more effective because it allows the formation of smaller bubbles (in the micron range), with a larger contact surface.

Finally, to improve this method different compounds can be added in the experiment. For example, the addition of coagulating agents such as aluminum and ferric salts or polymer coagulant improves the efficiency of the flotation process.

Magnetic nanomaterials also have interesting properties which can be used in flotation technology, they help reduce the time needed to treat wastewater and allow the foam formed to remain stable. For that reason, the elimination of pollutants is therefore facilitated.

#### Acknowledgements

This work was supported by a grant of the Romanian National Authority for Scientific Research and Innovation, CNCS/CCCDI – UEFISCDI, project number PN-III-P2-2.1-PTE-2016-0183, no. 25/2016.

#### References

- [1] Quéméneur M, Marty Y., Fatty acids and sterols in domestic wastewaters, *Water Res*,28(5):1217-26, 1994
- [2] Mondal P, Flotation: As Primary Treatment of Waste Water (explained with diagram), *Your Article Library*, 2014
- [3] Beychok M, Schematic flow diagram of the hydraulic version of the Induced gas flotation (IGF) process, *Citizendium*, 2011
- [4] Salam J. AlMaliky, Hayder A. AlAjawi, Nidaa A. AlBayati, Study of Induced Air Flotation for the removal of Oils from the effluents of Sweets and Dairy Industries, *The Iraqi Journal For Mechanical And Material Engineering, Special Issue (C)*
- [5] JWC Environmental, What is a DAF? How does a DAF Work? Dissolved Air Flotaiton, *JWCE*, Available on : <https://www.jwce.com/knowledge-center/what-is-a-daf/>
- [6] Zabel TF, *Flotation in Water Treatment, Innovations in Flotation Technology Springer*, 1992
- [7] ArrMaz, Flotation reagents & collectors Flotation, Available on: <https://arrmaz.com/products/mining-chemicals/flotation-reagents-collectors/>
- [8] Covaliu C. I., Moga I. C., Vasile E., Matache M. G., Petrescu G., Effect of CuFe<sub>2</sub>O<sub>4</sub> Nanoparticles on Fronth Stability in Wastewater Treatment by Flotation, *Revista de Chimie*, 68, 12 , 2796-2798, 2017.

# MODELING, SIMULATION AND STUDY OF LOADS AND DEFORMATIONS IN TRACTION DEVICES

Ing. Cristescu Andreea-Catalina.<sup>1</sup>, Dr. Ing. Popa Lucretia<sup>1</sup>, Drd. Ing. Stefan Vasilica<sup>1</sup>,  
Ing. Anghelut Alexandra<sup>1</sup>

National Institute of Research - Development for Machines and Installations Designed to  
Agriculture and Food Industry – INMA, Bucharest<sup>1</sup>

## ABSTRACT

This paper aims to simulate the stresses and deformations occurring in the traction elements, depending on the material used in the manufacture, but also depending to the chosen shape. The purpose of the paper is to determine an optimal variant which can withstand the loads arising during use. The coupling devices have been designed and tested for resistance using a finite element, namely SolidWorks Simulation, to determine if rupture or deformation results from the stresses that occur during the movement.

## 1. INTRODUCTION

The system of coupling devices for tractors, trailers and agricultural equipment is not isolated from the rest of the system and from the rest of the physical system of the equipment components. Coupling systems and the machine-binding system are binding through components of different types to the other components of the physical system (machine). Finally, the last link of the system, in the most general sense, is the coupler, which is the source of the system's excitation, in order to optimize the moment by changing the input elements [1, 2]. Couplings made permanent or intermittent connection between two consecutive elements of a transmission, in order to transmit the rotational movement and torque without changing the law of motion [3, 8].

The conditions that couplings have to fulfill are: safety in operation; reduced gauge dimensions; easy assembly and dismantling; statically and dynamically balance; insurance of high durability. Couplings transmit shocks and vibrations, mounting it with the condition of respecting the coaxiality of the shafts.

For coaxing axles, assembly and/or operation, which have coaxial deviations, rigid mobile clutches are used- or elastic assemblies – which, thanks to the elastic element, cushion shock and vibration are absorbed. In addition, to taking a deviation into certain limits, the frequency of the system, which determines this frequency beyond the speed range, changes. In this way, the effect of the dynamic loads is diminished, the energy of these loads being temporarily stored in the form of a potential energy in the elastic element and rendered, upon the termination of the dynamic load action, to the system of the coupling [4, 5].

### **Classification of coupling systems for tractors, trailers and agricultural and forestry equipment**

If a number of types and possibilities of locating are identified for coupling systems mounted on the tractor vehicle, three trailer coupling possibilities are known for the towed vehicle (trailers, agricultural or forestry equipment) after as follows:

- coupling through the eye (s) of tow;
- coupling by towing vehicle;
- coupling via the coupling triangle [6].

Towing eye is a coupling system intended in general to equip the trailers and sometimes, also the agricultural or forestry equipment, on a case-by-case basis, having different constructional shapes, with the exception of the actual coupling element which is standardized

---

<sup>1</sup>Street Libertatii, No. 7, Slatina, Olt, Romania, 0760968356, [andreea.catalina.cristescu@gmail.com](mailto:andreea.catalina.cristescu@gmail.com)

at national level and at European level. A situation will be detailed in the following chapters. Figure 1 shows the two representative types of towing eye [7].



Figure 1: Towing eye

## 2. METHODOLOGY

In order to carry out the study, two towing eyes of different shapes were designed in SolidWorks, each one with two materials: Alloyed steel 40C10 and High Quality Carbon Steel C45, in order to define the best solution.

### Study 1: Towing eye Type A, Alloyed steel 40C10

Properties:

- Material: Alloyed steel 40C10 (EN 10083-20)
- Mass / Volume 7.47 kg / 0.000957776 m<sup>3</sup>

Table 1: Load

Load name	Selection set	Loading type
Force/ Torque-1	On 2 Edges, 38 Faces apply force -10000 kgf normal to reference plane with respect to selected reference Face < 1 > using uniform distribution	Sequential Loading
Gravity-1	Gravity with respect to Top Plane with gravity acceleration -9.81 m/s <sup>2</sup> normal to reference plane	Sequential Loading

### Study Results

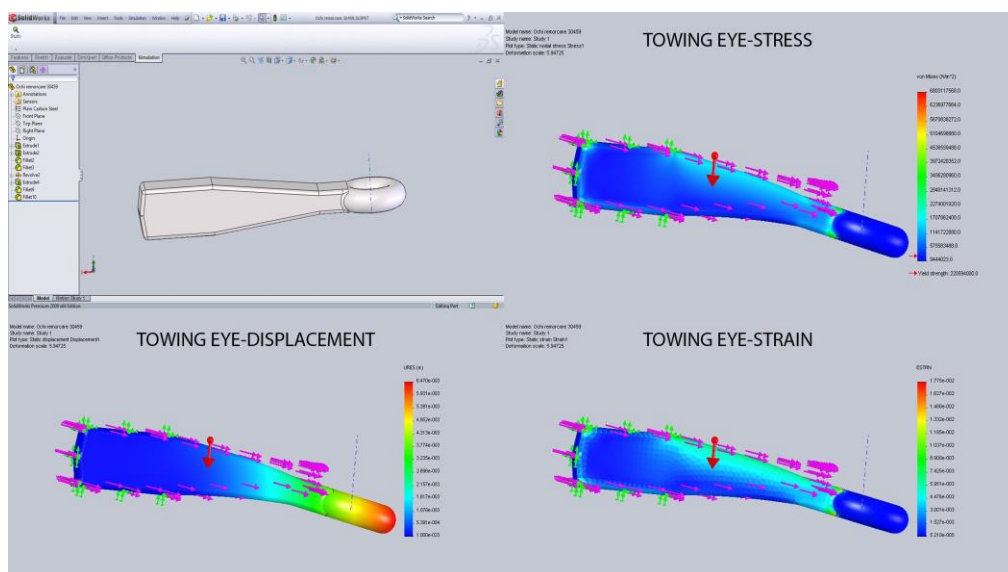

Figure 2: Towing Eye Type A, Alloyed steel 40C10 - Stress, Displacement and Strain

Table 2: Default Results

Name	Type	Min	Location	Max	Location
Stress1	VON: von Mises Stress	9.44402e+006 N/m <sup>2</sup> Node: 48222	(-237.822 mm, -34.8256 mm, -35.4543 mm)	6.80312e+009 N/m <sup>2</sup> Node: 1608	(22.5 mm, 32.5 mm, -22.5 mm)
Displacement1	URES: Resultant Displacement	0 m Node: 1453	(22.5 mm, -32.5 mm, 22.5 mm)	0.0064697 m Node: 49973	(-256.553 mm, -35.3454 mm, 0.08228 mm)
Strain1	ESTRN: Equivalent Strain	5.21043e-005 Element: 11282	(-242.743 mm, -22.7902 mm, 3.86527 mm)	0.0177479 Element: 17803	(20.322 mm, 31.3121 mm, -20.6672 mm)

**Study 2: Towing eye Type A, High Quality Carbon Steel C45**

Properties:

- Material: High Quality Carbon Steel C45 (EN 10277-2-2008)
- Mass: 7.47 kg; Volume: 0.000957776 m<sup>3</sup>

Table 3: Load

Load name	Selection set	Loading type
Force/Torque-1 < <b>Towing Eye</b> Type A>	On 2 Edge(s), 38 Face(s) apply force -10000 kgf normal to reference plane with respect to selected reference Face< 1 > using uniform distribution	Sequential Loading
Gravity-1	Gravity with respect to Top Plane with gravity acceleration - 9.81 m/s <sup>2</sup> normal to reference plane	Sequential Loading

**Study Results**

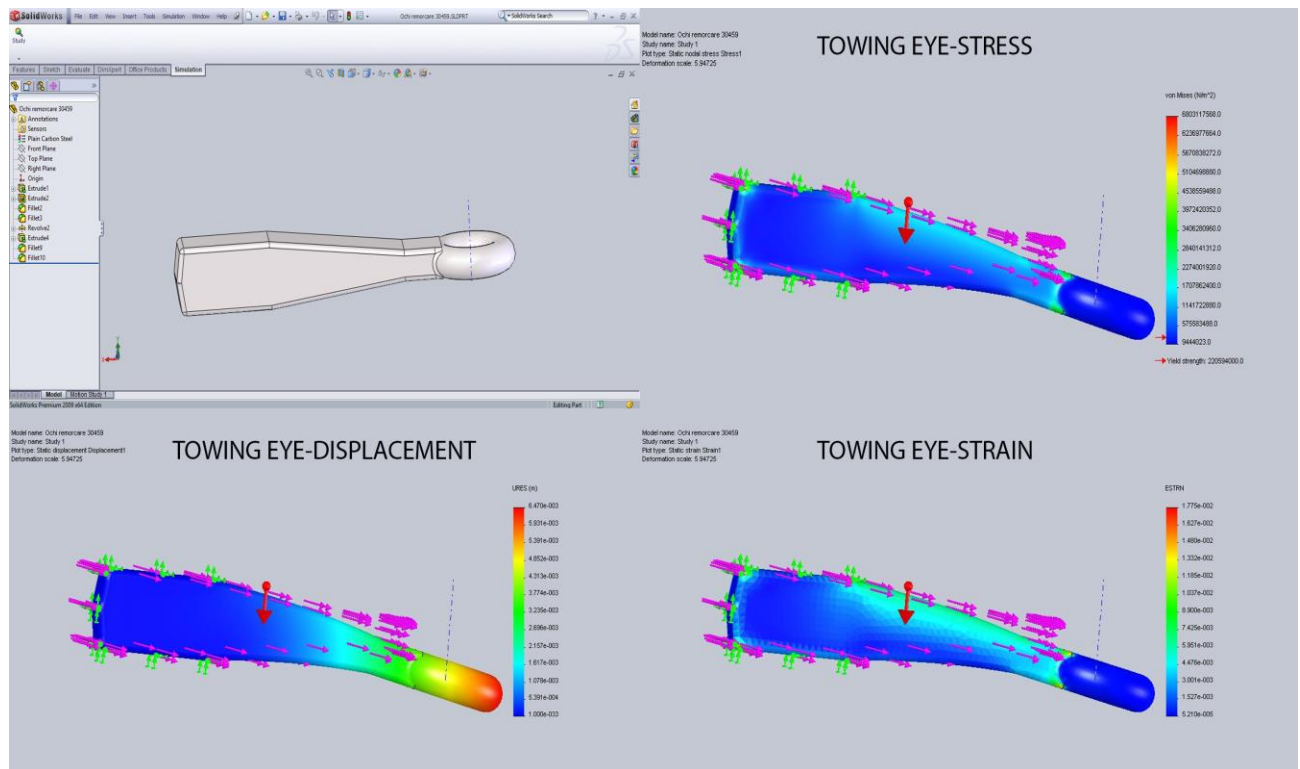

Figure 3: Towing Eye Type A. High Quality Carbon Steel C45 - Stress, Displacement Strain

Table 4: Default Results

Name	Type	Min	Location	Max	Location
Stress1	VON: von Mises Stress	9.44402e+006 N/m <sup>2</sup> Node: 48222	(-237.822 mm, -34.8256 mm, -35.4543 mm)	6.80312e+009 N/m <sup>2</sup> Node: 1608	(22.5 mm, 32.5 mm, -22.5 mm)
Displacement1	URES: Resultant Displacement	0 m Node: 1453	(22.5 mm, -32.5 mm, 22.5 mm)	0.0064697 m Node: 49973	(-256.553 mm, -35.3454 mm, 0.08228 mm)
Strain1	ESTRN: Equivalent Strain	5.21043e-005 Element: 11282	(-242.743 mm, -22.7902 mm, 3.86527 mm)	0.0177479 Element: 17803	(20.322 mm, 31.3121 mm, -20.6672 mm)

**Study 3: Towing eye Type B, Alloyed steel 40C10**

Properties:

- Material: Alloyed steel 40C10 (EN 10083-2)
- Mass: 7.78 kg; Volume: 0.000997362 m<sup>3</sup>

Table 5: Load

Load name	Selection set	Loading type
Force/Torque-1 < Towing Eye Type B >	On 27 Face(s) apply force 10000 kgf along axial. with respect to selected reference Face< 1 > using uniform distribution	Sequential Loading
Gravity-1	Gravity with respect to Top Plane with gravity acceleration -9.81 m/s <sup>2</sup> normal to reference plane	Sequential Loading

**Study Results**

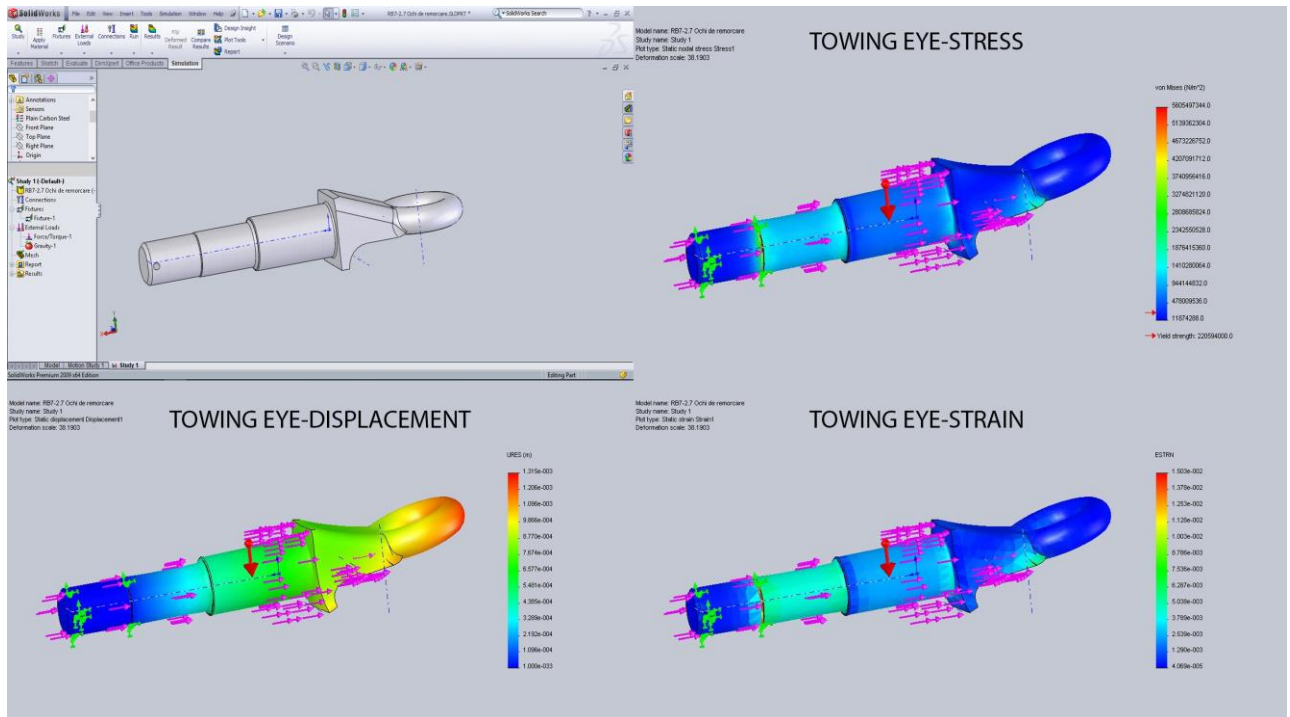

Figure 4: Towing Eye Type B Alloyed steel 40C10 - Stress, Displacement Strain

Table 6: Default Results

Name	Type	Min	Location	Max	Location
Stress1	VON: von Mises Stress	1.18743e+007 N/m <sup>2</sup> Node: 7471	(239.547 mm, 8.00132 mm, -4.24447 mm)	5.6055e+009 N/m <sup>2</sup> Node: 11563	(171.673 mm, 2.48971 mm, -23.7502 mm)
Displacement1	URES: Resultant Displacement	0 m Node: 174	(234 mm, -1.11022e-013 mm, -24 mm)	0.00131547 m Node: 13303	(-202.792 mm, 17.0022 mm, 0.935685 mm)
Strain1	ESTRN: Equivalent Strain	4.06887e-005 Element: 1975	(223.895 mm, -2.82805 mm, 1.69866 mm)	0.0150321 Element: 2180	(170.903 mm, 19.4192 mm, 12.1113 mm)

**Study 4: Towing eye Type B, High Quality Carbon Steel C 45**

Properties:

- Material: High Quality Carbon Steel C45 (EN 10277-2-2008)
- Mass: 7.77 kg; Volume: 0.000997362 m<sup>3</sup>

Table 7: Load

Load name	Selection set	Loading type
Force/Torque-1 < Towing eye Type B>	On 27 Face(s) apply force 10000 kgf along axial. with respect to selected reference Face< 1 > using uniform distribution	Sequential Loading
Gravity-1	Gravity with respect to Top Plane with gravity acceleration -9.81 m/s <sup>2</sup> normal to reference plane	Sequential Loading

**Study Results**

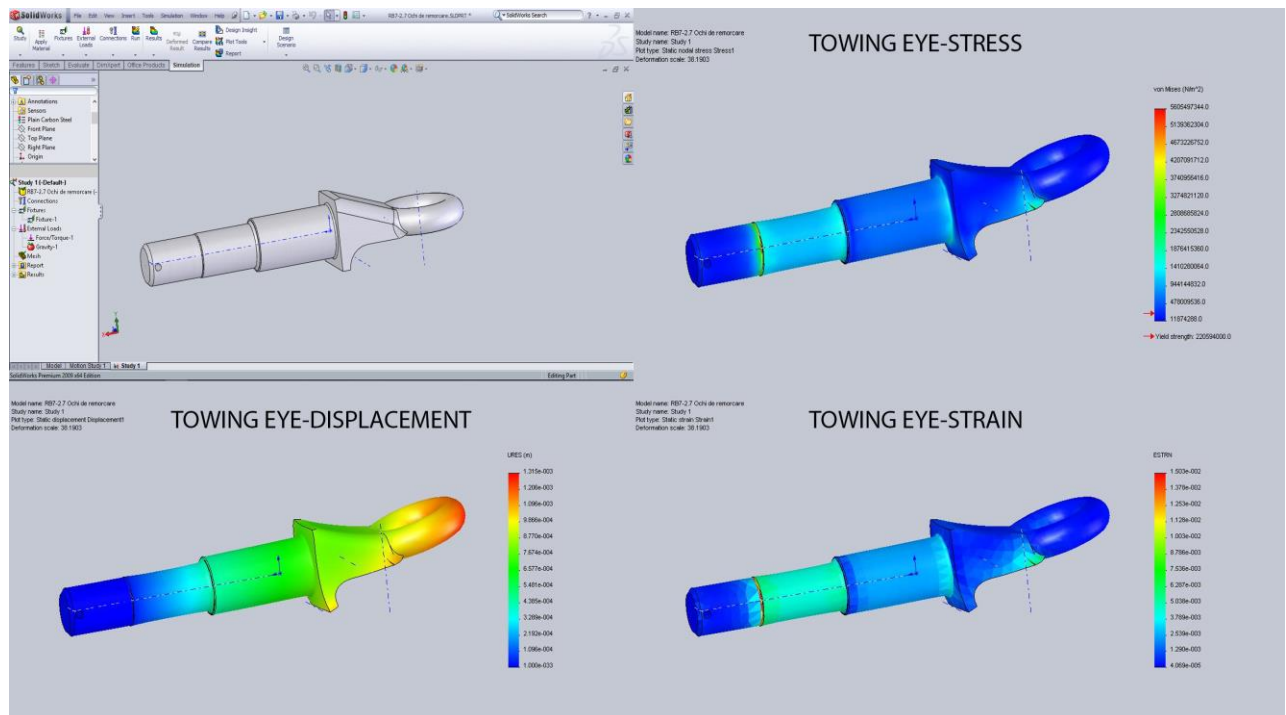

Figure 5: Towing eye Type B, High Quality Carbon Steel C45 – Stress, Displacement and Strain



Table 8: Default Results

Name	Type	Min	Location	Max	Location
Stress1	VON: von Mises Stress	1.18743e+007 N/m <sup>2</sup> Node: 7471	(239.547 mm, 8.00132 mm, -4.24447 mm)	5.6055e+009 N/m <sup>2</sup> Node: 11563	(171.673 mm, 2.48971 mm, -23.7502 mm)
Displacement1	URES: Resultant Displacement	0 m Node: 174	(234 mm, -1.11022e-013 mm, -24 mm)	0.00131547 m Node: 13303	(-202.792 mm, 17.0022 mm, 0.935685 mm)
Strain1	ESTRN: Equivalent Strain	4.06887e-005 Element: 1975	(223.895 mm, -2.82805 mm, 1.69866 mm)	0.0150321 Element: 2180	(170.903 mm, 19.4192 mm, 12.1113 mm)

### 3. CONCLUSIONS

Single-axle or tread-bogie trailer tractors have a fixed draft with coupling eyes in welded version (type A) or in removable variant (type B). Through the trailer eye, a load is transferred from the trailer to the tractor, on the rear axle, between the tractor coupling and the towing eye, resulting in a vertical force (action on the tractor coupling and reaction to the towing eye) which causes deformation of the coupling eye.

Based on the simulation made with the SolidWorks program, it can be said that the recommended towing eye is Type A (welded towing eye) variant, and as a suitable material, 40C10, an alloyed cement steel with a content carbon lower than the OLC45 and which is easier to weld.

#### Acknowledgement

This work was supported by a project with European funds: POC/A1/A 1.2.3 “Partnership for knowledge transfer”– Section G, ”Research concerning the promotion of a new equipment design for transport of materials and agricultural product”

#### References

- [1] C. Bodea, I. Candea și I. Andrei, *Theoretical studies on the mechanical properties of the tractor semi-trailer unit with different placing, scientific works*, Brasov: Comec, 2008.
- [2] F. Csilcsér, *Transportul agricol modern*, Cluj-Napoca: Agratech, 1993.
- [3] C. Bodea, *Theoretical and experimental studies on couplings between tractor and semi-trailer*, University "Transilvania" of Brasov: Brasov, 2008.
- [4] R. Ciuperca, A. Nedelcu, C. Bodea, L. Popa, – *Research on making a chemical fertilizer machine and amendments with a weight of 10 tonnes*, Bucuresti: Scientific Works INMATEH-I, 2006.
- [5] L. Popa, R. Ciuperca, „ *Advantages of using agricultural semi-trailers over articulated trailers for transport*”, INMATEH-I, Bucuresti, 2001.
- [6] C. Bodea, *Theoretical and experimental studies on couplings between tractor and semi-trailers*, Brasov: University "Transilvania" of Brasov, 2008.
- [7] C. Bodea, I. Candea and S. Popescu, „ *Dynamic study of the trailer tractor unit on different tracks*,” *INMATEH-III*, vol. III, 2008.
- [8] V. Vlăduț, E. Maican, L. Apostol, N. Ungureanu, I. Dumitru și R. Oprescu, „ *Verification of loads by means of mechanical analysis / mechanical testing of the coupling devices of mobile agricultural aggregates*,” *INMATEH*, vol. 54, no. 1, pp. 39-46, 2008.

# CONSIDERATIONS ON THE USE OF DRONES IN PRECISION AGRICULTURE

Cujbescu Dan<sup>1</sup>, Persu Cătălin, Găgeanu Iuliana, Voicea Iulian, Gheorghe Gabriel, Vlăduțoiu Laurențiu, Dumitru Iulian, Oprescu Remus, Cristea Mario<sup>2)</sup>

<sup>1</sup>INMA Bucharest / Romania

<sup>2)</sup> SC Cantarpprod SRL

## ABSTRACT

The drone (unmanned aerial vehicle - UAV), is a flying device lacking the human pilot, being guided either by a digital automatic pilot situated on board or through the means of a remote control from a control center situated on ground. The paper presents a classification of the drones used in precision agriculture, taking into consideration that their more frequent use in precision agriculture has the objective of obtaining higher and more qualitative productions, of optimizing economic profits and of achieving integrated environmental protection.

## 1. INTRODUCTION

Modern agriculture continues to make significant progress in increasing the capacity of the food producing industry as response to increased population and demand. For example, progresses registered in chemical engineering, fertilization, irrigation, soil analysis and equipment (hardware and software) have revolutionized plant production and associated systems. In this evolution of agricultural techniques, modern agriculture has transformed more and more the technological progress throughout the entire agricultural flow such as: sowing, cultivating and harvesting crops, which require a large range of equipment, machinery, chemical products, etc.

In the field of precision agriculture, agricultural drones – the so called unnamed aerial vehicles (UAV) are used for studying terrains and/or for capturing extremely precise images of the fields and crops, due to the capacity to cover hundreds of hectares in a single flight. Images obtained are analyzed, processed and transformed through the means of software programs in one or more ortho-mosaic images with the help of which are established the vegetation indices and the degree of crop irrigation is evaluated, etc. [7]. This way, considerable potential savings can be made, plants can be healthier and better yields can be obtained for the monitored crops. This is a model of situation where everyone has benefits: a manner of practicing agriculture using technology. It is a money saving and very effective way, contributing to environmental protection and ensuring food for the entire planet [4].

Monitoring of resources and vegetation state is conducted using contactless sensors, automated data acquisition being correlated with GPS coordinates (data georeferentiation) and their processing in the GPS system (Geographic Information System) for achieving the maps necessary for spatial and precision management [9].

Nowadays, in the common farmers' practices, sensor-based monitoring for plant growth throughout the season and nitrogen absorption uses devices fitted on the tractor, allowing nitrogen applications with variable flow rates correlated with the working speed [8, 10]. The use of drones instead of tractors offer an option for agricultural lots with difficult conditions, for example wet soils, where tractors cannot be driven without causing soil compaction [5].

---

<sup>1</sup>dcujbescu@yahoo.com

Currently, drone development in agriculture experiences a continuous growth, existing a variety of types, out of which UAVs with fixed wings and multi rotor ones are the most dominant types [12].

## 2. METHODOLOGY

Depending on the altitude and the duration of flight, drones can be classified as follows [13]:

- MAVs (Micro or Miniature Air Vehicles);
- NAVs (Nano Air Vehicles);
- VTOL (Vertical Take-Off & Landing);
- LASE (Low Altitude, Short-Endurance);
- LALE (Low Altitude, Long Endurance);
- MALE (Medium Altitude, Long Endurance);
- HALE (High Altitude, Long Endurance).

Table 1 presents the classification of drones depending on their weight [1]:

Table 1. Classification of drones by weight

Name	Weight [kg]
Super heavy	>2000
Heavy	200-2000
Average	50-200
Light	5-50
Micro	≤5

Figure 1 presents a classification of drones according to their wingspan and weight.

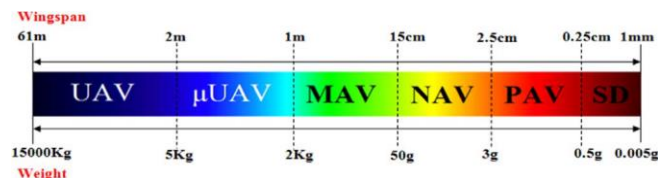

Fig. 1 Classification of drones taking into account their wingspan and weight

From the analysis of figure 1 is observed that there is a wide specter of drones starting from the UAVs with a maximum wingspan of 61 m and a weight on 15000 kg [15] up to smart dust (SD) with a minimum dimension of 1 mm and a weight of 0.005 g [11].

In figure 2 is presented a classification of drones depending on their configuration:

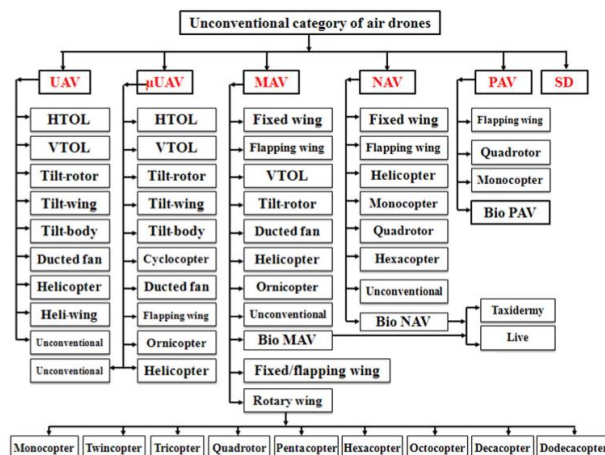

Fig. 2 Classification of drones depending on their configuration

The main aspects distinguishing UAVs from other types of small drones (such as MAVs and NADs) include the operational purpose of the vehicle, the materials used for producing it, as well the complexity and cost of the control system [2]. It is observed that UAVs can be considered as HTOL (horizontal take-off & landing), VTOL (vertical take-off & landing), hybrid models (with inclined wing, inclined rotor, inclined body and with propeller), heliwing and other nonconventional types [3].

Drones have a variety of day to day applications, appreciating that, depending on their type, drones will have more than two hundred applications [14, 18]. In figure 3 is presented a classification of the applications that can be performed by drones.

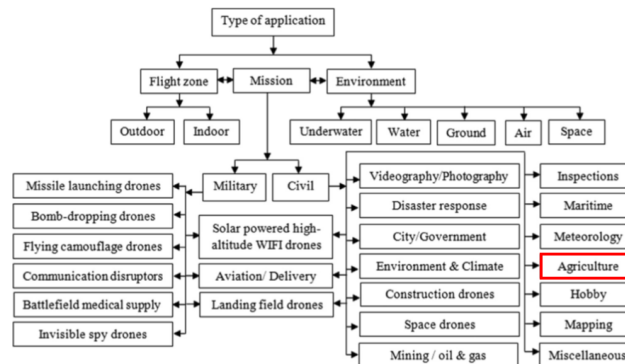

Fig. 3 Classification of drones' applications

The more and more frequent use of drones in agriculture has as objectives to obtain bigger and higher quality productions, to optimize economic profits, to achieve an integrated environment production. By using drones in agriculture, farmers can benefit from maps containing information on vegetation indices. Through the means of these maps, farmers would have the possibility to pulverize fertilizers where the soil is lacking nutrients, could irrigate only the dry areas or could treat only the plants that need protection against pests [16].

Figure 4 presents the schematic diagram of using drones in agriculture.

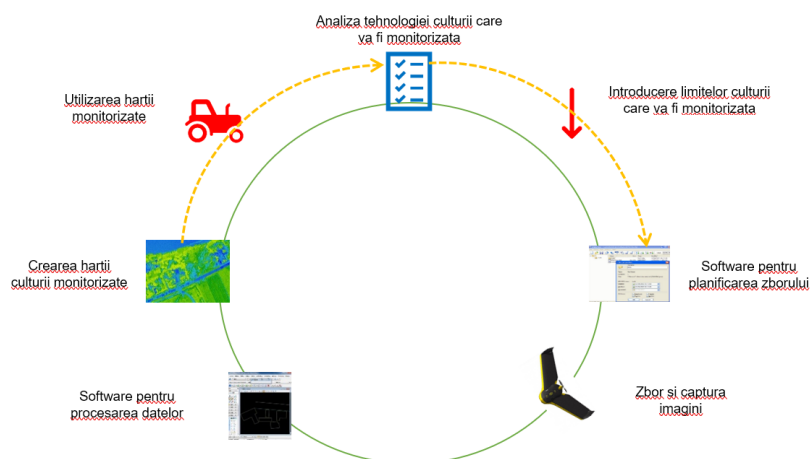

Fig. 4 The schematic diagram of using drones in agriculture

The use of drones is continuously growing worldwide, because compared to other methods of aerial monitoring, drones generate data more and more precise on the state of the crop. Also, the economic character of using drones is not to be neglected, for monitoring

exploitations with a dimension smaller than 50 hectares, drones being cheaper than surveillance through the means of planes or satellite images. Data obtained using drones are used in different ways to improve the performance of exploiting a farm. Below are presented a series of solutions used worldwide for monitoring crops:

#### 1. SenseFly eBee SQ [21]



Fig. 5 SenseFly eBee SQ

For starting, the limits of the crop need to be uploaded. To launch a new monitoring, only the study area and image have to be established, then the software generates an optimal flight plan. Technical specifications: wingspan is 110 cm; approximate weight 1.1 kg maximum flight load; Lithium Polymer batteries; flight duration of approximately 55 minutes; flying speed of 40-110 km/h (11-12 m/s); resistance to winds with speeds up to 45 km/h (12 m/s); soil sensors and technology for reversing the propeller's rotation for a short landing; radio connection up to 3 km; SEQUIA type photographic camera, completely electronically controlled and integrated; memory for recording parameters for flying and for the incorporated camera; can cover up to 10 km<sup>2</sup>, depending on the resolution chosen for the orthophotos; flight simulator; real time control and information on the mission; easy management for the flight data (creating kml files, memorizing the flight plan).

#### 2. PrecisionHawk Lancaster 5 [20]



Fig. 6 PrecisionHawk Lancaster 5

This drone is endowed with multispectral sensor oriented in a descendant sense and other sensors monitoring air humidity, temperature and pressure together with incident light, all in real time. Also, this type of drone uses artificial intelligence to react to changing weather conditions, useful load, aeolian load changing, visibility, etc. Flight planification is done by setting the target altitude and the desired soil resolution, and the drone automatically creates a flight plan. When the monitoring ends, the drone will automatically land. The monitoring and tracking software offers real time data on flight trajectory, position, altitude, drone performance and battery life. A large range of sensors are available for capturing visual, thermal/IR, multispectral, LIDAR and hyperspectral data. Technical specifications: 5.3 kg weight; useful load of 1 kg; flight duration of 45 minutes; flight distance 2 km; monitored surface of 1.2 km<sup>2</sup> per flight (90 m altitude); plug-and-play sensor; multispectral device with 5 available channels; data resolution up to 1 cm / pixel.

### 3. AGCO Solo [19]



Fig.7 AGCO Solo

AGCO solo is an automated pilot drone equipped with photographing camera. With this type of drone is possible to obtain completely autonomous aerial maps and high-resolution maps with the help of which, farmers can rapidly and efficiently identify the areas with problems in the crops grown. Technical specifications: maximum flight speed of 88 km/h; resistance to winds up to 56 km/h; flight duration of 25 minutes per flight; 2 cameras personalized with lenses specially designed for aerial cartography.

### 4. Predator-1115 [17]



Fig. 8 Predator-1115

Predator-1115 is a professional octocopter, ready to fly, requiring a space for take-off / landing on vertical of only 3 m. The drone stands out by its power, has a long flight duration, rigid carbon fiber construction and complete autonomous GPS navigation functions. The drone can be wirelessly configured using a PC. Technical specifications: maximum motors' power: 196 N or 20 kgf; motor power: 720 W; diameter between motors: 1115 mm; Li-Po battery: 30 A/6S; useful recommended load: 1500 g; maximum load at take-off: 9500 g; total weight during flight without load: 7400 g with Li-Po 30A/6S; flight time with recommended load: 35 min; maximum flight time with one battery and without load: 56 min until battery wears out; maximum flight speed: 80 km/h; maximum ascension speed: 15 m/s; multi-standard GNSS module: Navstar, Galileo, Glonass, BeiBDou, QZSS; flight controller: Pxlhawk 32; maximum control distance: 5 km; radio control band: 2.4ghz bidirectional; telemetry link for PC: 433 Mhz Duplex; very stable flight even at maximum wind speed 50 km/h; maximum flight altitude: 3500 m; working temperature: -10 up to +60 degrees Celsius.

Drones with fixed wings can fly with loads bigger than multi rotor drones – meaning that they can use more sensors – therefore more images can be captured and analyzed in a single flight. This can reduce the total time for data collection and implicitly the time of processing them.

## 3. CONCLUSIONS

The continuous improvement of drones will combine the benefits of fixed wings with those of platforms with rotating wings.

The possibilities to coordinate the missions of teams with aerial and terrestrial vehicles, as well as an improved communication between them have the potential to promote drones for contributing to agricultural development.

Due to the fact that drones handling, as well as data processing is still a rather complicated process, the implementation of online services for processing data and generating application maps, will facilitate the process of generating information, thus simplifying an easy use of data even by unexperimented users. Future direction of development for drones used in precision agriculture should be directed on producing completely autonomous drones.

## ACKNOWLEDGEMENT

This work was funded by the Ministry of Research and Innovation, within the project entitled PN 18 30 01 01: “Experimental research on the aerial mapping of agricultural crops corresponding to the Agriculture 4.0 concept”, ctr. 18N/16.03.2018

## References

- [1]. Arjomandi A, Agostino S., Mammone M., Nelson M., Zhou T., *Classification of Unmanned Aerial Vehicle*, Report for Mechanical Engineering class, University of Adelaide, Adelaide, Australia, 2006.
- [2]. Cai G., Dias J, Seneviratne L., *A survey of small-scale unmanned aerial vehicles: recent advances and future development trends*, *Unmanned Syst. 2* (02), pp.175–199, 2014;
- [3]. Cavoukian A., *Privacy and Drones: Unmanned Aerial Vehicles*, Information and Privacy Commissioner of Ontario, Canada, pp. 1–30, 2012;
- [4]. Geipel J., *Implementation and Improvement of an Unmanned Aircraft System for Precision Farming Purposes*, Dissertation, Institute of Crop Science, University of Hohenheim, Department of Agronomy, 2016
- [5]. Gnypl M. L., Panitzki M., Reusch S., Jasper J., Bolten A., Bareth G., *Comparison between tractor-based and UAVbased spectrometer measurements in winter wheat*, *Proceedings of the 13<sup>th</sup> International Conference on Precision Agriculture*, Missouri, pp. 1-10, USA, 2016
- [6]. Hassanaliam M., Abdelkefi A., *Classifications, applications, and design challenges of drones: A review*, *Progress in Aerospace Sciences* 91, pp. 99–131, 2017
- [7]. Kahn J.M., Katz R.H, Pister K.S., *Next century challenges: mobile networking for Smart Dust*, in: *Proceedings of the 5th annual ACM/IEEE international conference on Mobile computing and networking*, ACM, pp. 271–278, 1999;
- [8]. Lammel J., Wollring J., Reusch S., *Tractor based remote sensing for variable nitrogen fertilizer application*. In: Horst, W.J. et al (Eds.), *Plant nutrition – Food security and sustainability of agro-ecosystems* (pp. 694-695). Dordrecht Klumer Academic Publishers, 2001
- [9]. Luculescu M. C., *Applications of advanced mechatronic systems in agriculture, industry and medicine*, Habilitation thesis, University Transylvania of Braşov, 2017
- [10]. Mistele B., & Schmidhalter U., *Tractor-based quadrilateral spectral reflectance measurements to detect biomass and total aerial nitrogen in winter wheat*. *Agronomy Journal*, 102 (2), pp. 499-506, 2010
- [11]. O'Connor R. M., Di Federico I. G., *AGRICULTURAL CROP ANALYSIS DRONE*, Patent Application Publication, No.: US 2017/0015416 A1, 2017
- [12]. Pircher M., Geipel J., Kusnierek K., Korsaeht A., *Development of a hybrid uav sensor platform suitable for farm-scale applications in precision agriculture*, *The International Archives of the Photogrammetry, Remote Sensing and Spatial Information Sciences*, Volume XLII-2/W6, International Conference on Unmanned Aerial Vehicles in Geomatics, pp. 297-302, Bonn, Germany, 2017
- [13]. Watts A.C., Ambrosia V.G, Hinkley E.A, *Unmanned aircraft systems in remote sensing and scientific research: classification and considerations of use*, *Remote Sens. 4* (6), pp. 1671–1692, 2012
- [14]. <http://air-vid.com/wp/20-great-uav-applications-areas-drones>
- [15]. [https://en.wikipedia.org/wiki/Boeing\\_Condor](https://en.wikipedia.org/wiki/Boeing_Condor)
- [16]. <http://www.asro.ro/?p=4000>
- [17] <http://fae-drones.com/produse/Drona-FAE-1115-Octa-PREDATOR-40.html>
- [18]. <https://www.microdrones.com/en/applications>
- [19] [https://www.pages05.net/agco/SOLO\\_UAV/](https://www.pages05.net/agco/SOLO_UAV/)
- [20]. <http://www.precisionhawk.com/agriculture#package-details>
- [21]. <https://www.sensefly.com/drones/ebee-sq.html>

# APPLICATIONS AND PERSPECTIVES OF USING DRONES IN PRECISION AGRICULTURE

Cujbescu Dan<sup>1</sup>, Persu Cătălin, Găgeanu Iuliana, Voicea Iulian, Gheorghe Gabriel, Vlăduțoiu Laurențiu, Ungureanu Nicoleta<sup>2</sup>, Vlad Cristina<sup>3</sup>

<sup>1</sup>INMA Bucharest,

<sup>2</sup>Politehnica University of Bucharest,

<sup>3</sup>ICEADR – Bucharest

## ABSTRACT

Modern applications used in precision farming require databases with high spatial and temporal resolution. The purpose of this paper is to show the development, applicability, perspectives and need of unmanned aerial vehicles (drones) as sensors platforms that offer both easy and accurate coverage of the analysed surfaces. At present time, remote detection through drones plays an important role in crop monitoring and has high efficiency, high resolution, low costs and risks.

## 1. INTRODUCTION

Remote detection through drones is mainly used for crop classification, disaster monitoring, crop density, agronomic parameter estimation [5,6].

In the researches regarding crop classifications, drones acquire data mainly regarding different types of sowed surfaces in order to facilitate crop management and taking the corresponding decisions [4,8].

Monitoring in case of disaster includes both monitoring pests on the analysed surface, as well as abnormal crop growth caused by external factors [1,2].

Crop density was estimated using image processing algorithms and RGB images. RGB is an additive colour model where light is emitted, and by overlapping primary colours (red, green, blue) are obtained the secondary colours. By uniting the three colour is possible to obtain white. Each of the primary colours has 256 shades, totalizing 16777216 colour shades (R: 256 x G: 256 x B:256) [7,10].

Currently, the industry of drones used in agriculture experiences a continuous growth, disposing of various platforms, out of which, fixed wings drones and multi-rotor drones being predominant [3,9].

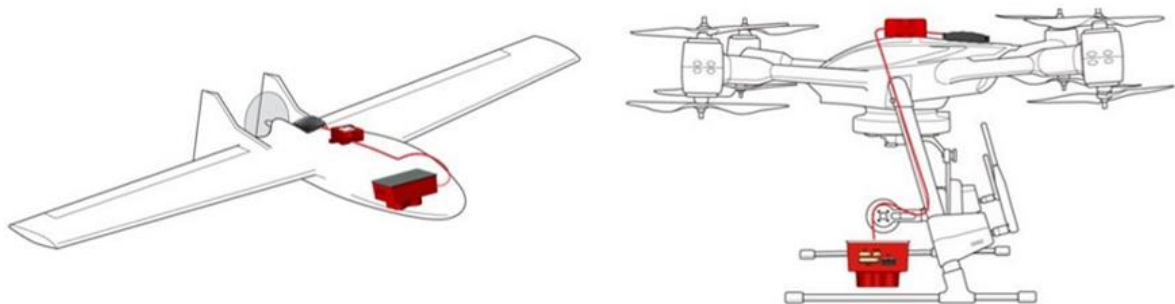

Figure 1: Integrated a multispectral sensor on fixed wings drones or on multi-rotor drones

---

<sup>1</sup>dcujbescu@yahoo.com



## 2. METHODOLOGY

The stages of using drones in precision agriculture are:

➤ planning – a region of the map is added and the optimized mission for points is automatically generated. Depending on the sensor attached, the desired altitude above the soil is specified, the system indicating the resolution of the vertical and horizontal image, the estimated flight time, as well as the perimeter or the researched area.

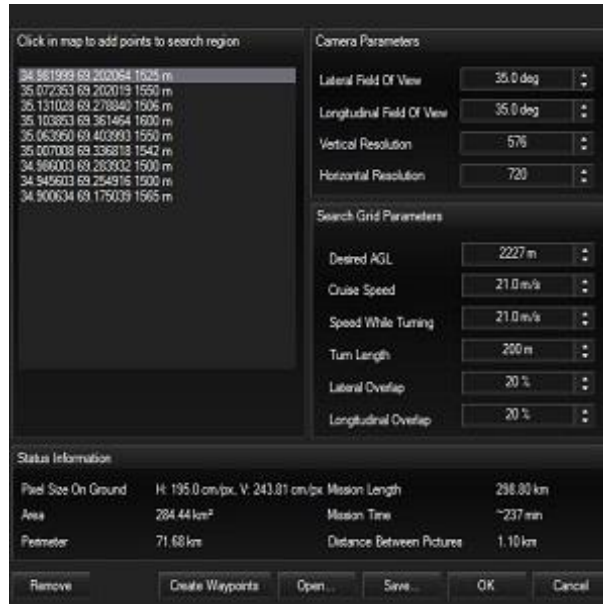

Figure 2: Flight planning [13]

➤ flying – the drone is launched in the air, and the operator will monitor the flight, through the means of the drone’s automated flight control system which also achieves its safe landing.



Figure 3: Flight realization [13]

➤ data transfer and analysis – after finalizing the flight, aerial photographs or NIR images are transferred from the drone to the portable soil command station for an additional image analysis. Through the means of a specialized software, images can be combined in large mosaics or it is even possible to create 3D parcels / altitude profiles for the researched area.

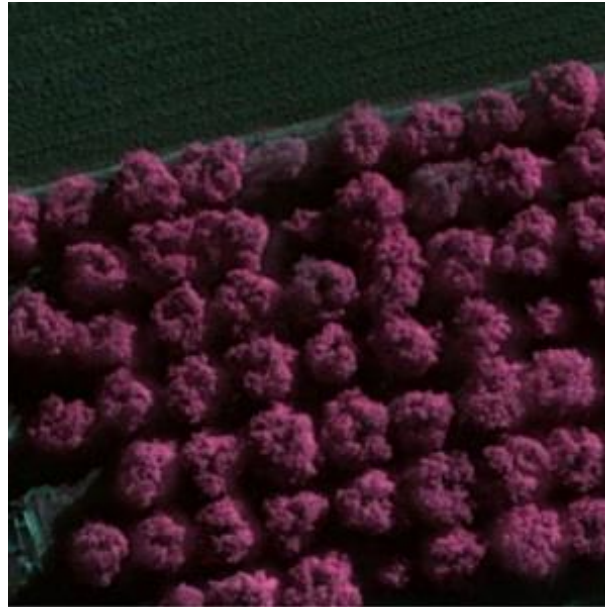

Figure 4: Image analysis [13]

➤ result – after analysing and processing the resulting data is possible, for example, to detect the stress of crops analysed (depending on the intensity of irrigation and the degree of water availability), the chlorophyll content or to detect water leaks, the final result of the analysis depends on the agrotechnical requirements of the monitored crop.

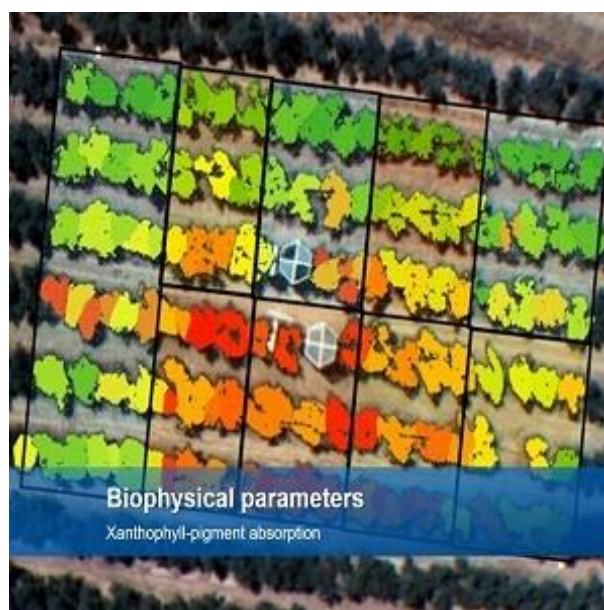

Figure 5: Result from analyzing and interpreting images [13]

Monitoring programs provide information on the evolution of crops in real time in order to assess areas of different productivity through the means of the Vegetation Index. The Vegetation Index is a mathematical transposition of the values of light reflected in the visible spectrum and in the infrared spectrum, is correlated with chlorophyll content, the total biomass quantity and plant photosynthesis activity. Beyond the visible spectrum, sensors fitted on the satellites are also sensitive to the spectrum of radiation that is imperceptible to the human eye. Near infrared (NIR) spectrum is the most used part of electromagnetic radiation used for vegetation monitoring.

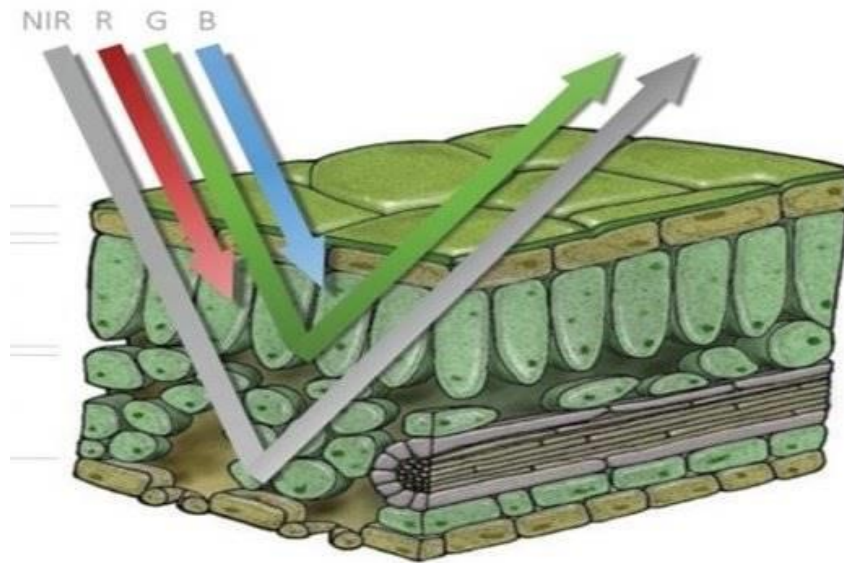

Figure 5: Light reflected in the visible spectrum and in infrared spectrum [14]

Also, with the help of multispectral and multiangle images provided by satellites, the monitoring system process, interpret and monitor the parameters of the agricultural terrain, the state and evolution of vegetation. Maps in the form of pixels are obtained in two ways: at absolute scale for comparing crops in different stages of development and at adjusted scale defined by the minimum and maximum values in the analysed crop.

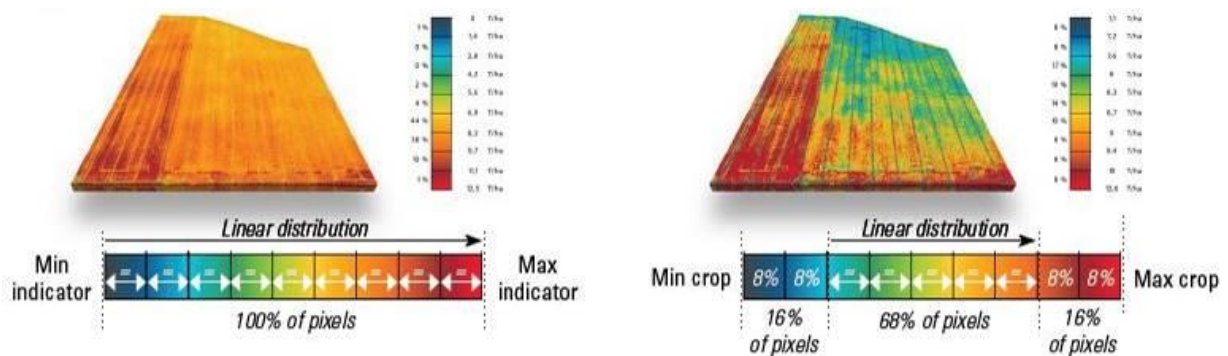

Figure 6: Maps in the form of pixels [11]

### 3. CONCLUSIONS

In the past, capturing multispectral data was achieved through the means of an aircraft with crew or by waiting for a satellite to fly over the surface to be monitored. Both options do not allow a big flexibility, are limited in terms resolution and can be affected by clouds covering the ski, which can damage the data. Now, along with a rapid expansion of the industry of commercial drones, anyone can fly a multispectral sensor over a crop and can rapidly detect the stress, not only at the level of the monitored crop, but also at the level of individual plants.

On-site research uses visual inspection to assess the condition of crops from the ground. Unfortunately, such techniques based on ground-level investigation are limited to what the human eye can perceive. Innovative technologies using multispectral quadrants and imaging have an extraordinary potential to complete on-site research.

Satellite images still have too high costs, satellites that offer high (1-5 m) and very high resolution (<1 m) spatial resolution are few (eg. WorldView 2 & 3, Quickbird, Pleiades). Satellites with the optical sensors listed above cannot capture clear ground surface images under unfavorable atmospheric conditions (fog, clouds, low light, etc.), temporal resolution is currently low (they have high revision periods of several days).

Drones offer images at lower costs, as clear and even at better spatial resolution than most existing satellites, field mapping is performed much faster, and only for areas of interest, images can be taken under less favorable conditions (drones fly under the skyscraper, while satellites cannot do this), have more flexibility with regard to the equipment used (is possible to add or change sensors, measuring devices, eg. LIDAR, spectral filters, etc.).

### ACKNOWLEDGEMENT

This work was funded by the Ministry of Research and Innovation, within the project entitled PN 18 30 01 01: “Experimental research on the aerial mapping of agricultural crops corresponding to the Agriculture 4.0 concept”, ctr. 18N/16.03.2018

### References

- [1]. Castaldi, F.; Pelosi, F.; Pascucci, S.; Casa, R. *Assessing the potential of images from unmanned aerial vehicles (UAV) to support herbicide patch spraying in maize*. *Precis. Agric.*, 18, 76–94, 2016
- [2]. Li, Z.; Chen, Z.; Wang, L.; Liu, J.; Zhou, Q. *Area extraction of maize lodging based on remote sensing by small unmanned aerial vehicle*. *Trans. Chin. Soc. Agric. Eng.*, 30, pp. 207–213, 2014
- [3] Pircher M., Geipel J., Kusnierek K., Korsaeht A. *Development of a hybrid uav sensor platform suitable for farm-scale applications in precision agriculture*. *The International Archives of the Photogrammetry, Remote Sensing and Spatial Information Sciences*, Volume XLII-2/W6, pp. 297-302, 2017
- [4]. Primicerio, J.; Gennaro, S.F.D.; Fiorillo, E.; Genesio, L.; Lugato, E.; Matese, A.; Vaccari, F.P. *A flexible unmanned aerial vehicle for precision agriculture*. *Precis. Agric.*, 13, pp. 517–523, 2012
- [5]. Sankaran, S.; Khot, L.R.; Carter, A.H. *Field-based crop phenotyping: Multispectral aerial imaging for evaluation of winter wheat emergence and spring stand*. *Comput. Electron. Agric.* 2015, 118, pp.372–379.
- [6]. Senthilnath, J.; Dokania, A.; Kandukuri, M.; Ramesh, K.N.; Anand, G.; Omkar, S.N. *Detection of tomatoes using spectral-spatial methods in remotely sensed RGB images captured by UAV*. *Biosyst. Eng.*, 146, pp. 16–32, 2016

- [7]. Sugiura, R.; Tsuda, S.; Tamiya, S.; Itoh, A.; Nishiwaki, K.; Murakami, N.; Shibuya, Y.; Hirafuji, M.; Nuske, S. *Field phenotyping system for the assessment of potato late blight resistance using RGB imagery from an unmanned aerial vehicle*. *Biosyst. Eng.*, 148, pp. 1–10, 2016
- [8]. Tian, Z.; Fu, Y.; Liu, S.; Liu, F. *Rapid crops classification based on UAV low-altitude remote sensing*. *Trans. Chin. Soc. Agric. Eng.*, 29, 109–116, 2013
- [9]. Vega, F.A.; Ramírez, F.C.; Saiz, M.P.; Rosúa, F.O. *Multi-temporal imaging using an unmanned aerial vehicle for monitoring a sunflower crop*. *Biosyst. Eng.*, 132, pp.19–27., 2015
- [10]. Watts A.C.; Kobziar L.N.; Percival H.F. Unmanned Aircraft Systems for Wildland Fire Monitoring and Research. In *Proceedings of the 24th Tall Timbers Fire Ecology Conference: The Future of Fire: Public Awareness, Health, and Safety*, Tallahassee, FL, USA, 11–15 January 2009; pp. 86–90.
- [11]. <https://www.airinov.fr/en/>
- [12]. <https://www.micasense.com/atlas/>
- [13] <http://www.uas-europe.se/index.php/applications/agriculture>
- [14]. <http://www.vantage-ro.com/geoscan/>

# A REVIEW REGARDING MODELS WHICH PREDICT LANDFILL GAS GENERATION

Mirela Dincă<sup>1</sup>, Mariana Ferdeş, Bianca – Ştefania Zăbavă, Nicoleta Ungureanu, Georgiana Moiceanu, Mariana Ionescu  
University Politehnica of Bucharest, Romania

## ABSTRACT

Once organic waste is landfilled, it starts decomposing under anaerobic conditions and generates landfill gas, a mixture of methane ( $\text{CH}_4$ ) and carbon dioxide ( $\text{CO}_2$ ). Since methane has a higher global warming potential than carbon dioxide, production of methane is important in estimating the greenhouse gas emissions from landfilled waste. Methane generation can be predicted using mathematical models. Most of these models were developed on Monod equation, and first – order kinetics are often used in methane production models, such as LandGEM, GasSim, Afvalzorg, EPER, etc. The purpose of this study is to describe the landfill gas generation stages and the most used models which predict methane gas generation over time from a mass of waste.

## 1. INTRODUCTION

The act of dumping wastes on landfill sites represents the oldest, cheapest and most common form of waste management [1]. According to Directive 1999/31/EC on the landfill of waste, the European Union Member States have adopted a general waste management policy in which landfilling is the least desired option [2].

Landfill gas is obtained during the anaerobic decomposition of organic substances found in municipal solid waste stored in a landfill. Landfill gas is generated as a result of physical, chemical and microbial processes occurring within the waste [3].

The biogas obtained from landfill consists mainly of methane ( $\text{CH}_4$ ) and carbon dioxide ( $\text{CO}_2$ ). These two gases are known as greenhouse gases,  $\text{CH}_4$  having a global warming potential 34 times that of  $\text{CO}_2$  over the 100 year time period [4]. Also, landfill gas contains some byproducts resulted from the biological decomposition process, such as ammonia ( $\text{NH}_3$ ) and hydrogen sulphide ( $\text{H}_2\text{S}$ ) [5].

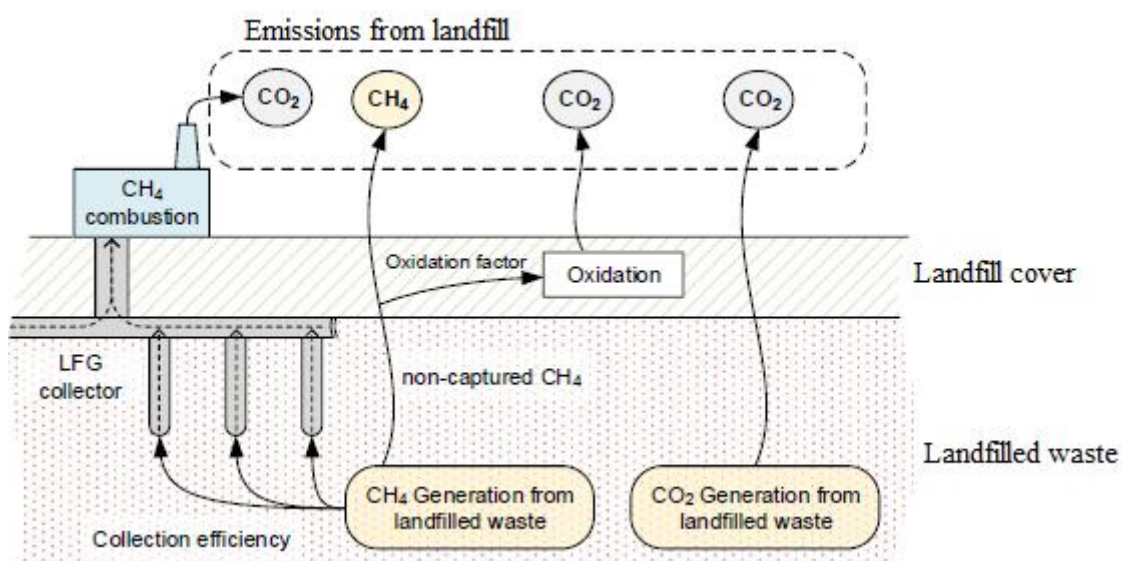

Figure 1: Landfill gas (LFG) emissions generated from landfilled organic waste [6]

<sup>1</sup>Splaiul Independentei 313, Sector 6, Bucharest, 0761938017, mirela\_dilea@yahoo.com

In order to avoid the emission into the atmosphere, methane gas may be collected, treated and used for generation of electricity or upgraded to power homes, buildings and vehicles. Landfill gas contains 50% methane (CH<sub>4</sub>), 45% carbon dioxide (CO<sub>2</sub>) and 5% nitrogen (N<sub>2</sub>) and other gases including trace amounts of non-methane organic compounds [7]. However, the landfill gas quality varies from time and degradation phase, location and gas collection. Thus, the gas composition is not constant [5].

The purpose of this study is to describe the landfill gas generation stages and the most used models which predict methane gas generation over time from a mass of waste.

## 2. METHODOLOGY

### *Landfill gas production*

The biological processes leading to the generation of methane from landfills have been well known for many years. Bacterial action leads to the generation of methane from organic substrates (eq. 1) [8].

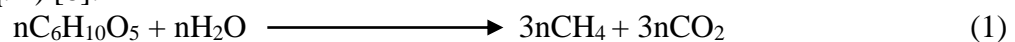

In figure 2 is presented the landfill gas generation curve, with the 8<sup>th</sup> stages.

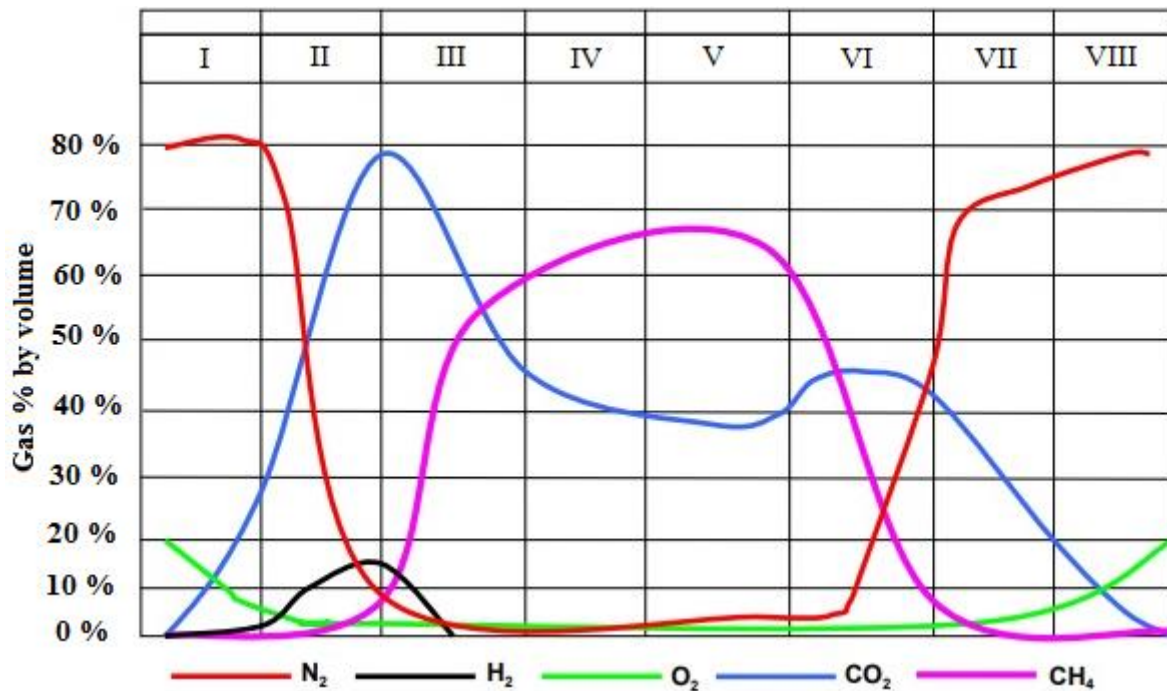

Figure 2: Landfill gas generation curve [9]

**Phase I** is an aerobic one, last for a few days to a number of months and depends on some factors such as temperature and moisture content. In **phase II** acts populations of facultative and anaerobic bacteria, which produce volatile acids, CO<sub>2</sub> and H<sub>2</sub>. **Phase III** involves methanogenic bacteria producing CH<sub>4</sub>. In this stage, the H<sub>2</sub> and CO<sub>2</sub> concentrations start to fall. During the **phase IV**, the remaining H<sub>2</sub> is used by methanogenic bacteria in the reduction of CO<sub>2</sub> to CH<sub>4</sub> and H<sub>2</sub>O. Typical landfill gas collected in this phase consists of 40 – 65 % by volume of CH<sub>4</sub> with most of the composition made up by CO<sub>2</sub>. In **phase V**, the rate of methanogenic activity begins to fall as substrate is used up. During the **phase VI**, the rate of air increase and the rates of methanogenesis have achieved low levels. **Phase VII** involves the return to aerobic conditions. Anaerobic decomposition becomes inhibited by the ingress of O<sub>2</sub>. At this

point, the rate of landfill gas formation has almost stopped because of substrate limitation. The final **phase, VIII**, occurs when degradable organic matter has been oxidised [9].

### 3. RESULTS AND DISCUSSION

One of the most important parameter in assessing the methane generation potential is the waste components, the maximum volume of biogas generation could be attributed to the quantity and type of organic material within the waste [4]. Studies have shown that temperature, climate, moisture content, pH and particle size also affect the reaction kinetics and the prediction of landfill gas production [10-12].

The gas extraction system design can also have an important impact on the gas generation cycle. Methane generation can be predicted using mathematical models. These models use various input parameters such as assumed half – life of waste degradation and waste composition which determine the amount of carbon in the waste mass that can be transformed into methane and carbon dioxide [13]. Most of these models were developed on Monod equation, and first – order kinetics are often used in methane production models, such as LandGEM, GasSim, Afvalzorg, EPER, etc.

Methane yield values used in models are estimated based on assumption about the amount of waste disposed, the composition of the waste and its biodegradability [12, 13].

**The Landfill Gas Emissions Model** (LandGEM) is an automated estimation tool with a Microsoft Excel interface that can be used to estimate emission rates for total landfill gas, methane, carbon dioxide, nonmethane organic compounds, and individual air pollutants from municipal solid waste landfills [14]. LandGEM is based on the following first-order decomposition rate equation and is able to estimate annual emissions over a specific time period [14]:

$$Q_{CH_4} = \sum_{i=1}^n \sum_{j=0.1}^1 k L_0 \left( \frac{M_i}{10} \right) * e^{-kt_{ij}} \quad (2)$$

where:  $Q_{CH_4}$  = annual methane generation in the calculation year ( $m^3$ /year);

$i$  = 1 year time increment;

$n$  = (calculation year) – (initial year of waste acceptance);

$j$  = 0.1 year time increment;

$k$  = methane generation rate ( $year^{-1}$ );

$L_0$  = potential methane generation capacity ( $m^3$ /Mg);

$M_i$  = mass of waste accepted in the  $i^{th}$  year (Mg);

$t_{ij}$  = age of the  $j^{th}$  section of waste mass  $M_i$  accepted in the  $i^{th}$  year (decimal years, eg. 3.2 years).

Inputs of LandGEM are: design capacity of the landfill; amount of waste in place; the methane generation rate constant,  $k$ , and methane generation potential,  $L_0$ ; the years of waste acceptance and acceptance of hazardous waste at the landfill. The outputs are the following: emission rate for methane; two sets of default values for emissions calculations are incorporated in the model; landfill closure estimates based on the landfill capacity and waste acceptance rate; emissions for individual pollutants and graphs of emissions for individual pollutants [13].

Lagos *et al.* [15] reformulated the LandGEM's equation in order to include two types of refuse, fast decaying refuse and slow decaying refuse, whose fractions and key modeling parameters  $k$  and  $L_0$  were optimized independently for three periods in the life of the Montreal-CESM landfill. They analyzed three scenarios and were compared to actual biogas collection data, namely: two-variable vscenario, where  $k$  and  $L_0$  were optimized for a single type of refuse; six-variable scenario, where three sets of  $k$  and  $L_0$  were optimized for the three periods and for a single type of refuse; and seven-variable scenario, whereby optimization was performed for two sets of  $k$  and  $L_0$ , one associated with fast decaying refuse and the second with slow decaying



refuse. Results showed that the lowest error from the error minimization technique was obtained with the six-variable scenario.

In figure 3 is presented the CH<sub>4</sub> generation obtained by the reformulated LandGEM equation, for the three scenarios considered. The curve with solid points represents data collected from 1994 to 2013 that were transformed into generation values by considering 75% recovery efficiency.

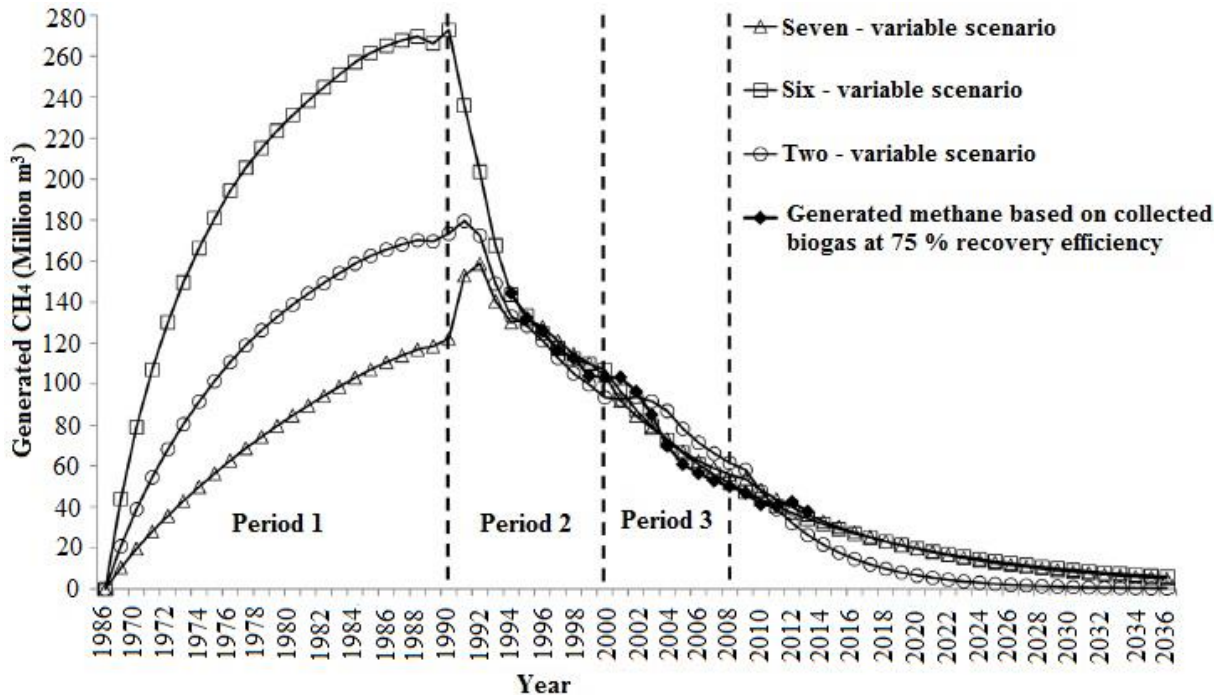

Figure 3: Modeled CH<sub>4</sub> generation for the two, six and seven-variable scenarios [15]

*GasSim* determines the generation of methane, carbon dioxide and hydrogen produced from the waste mass, waste composition and moisture content using a multiphase first order decay equation, for both methanogenic and acetogenic decay [16]. *GasSim* has been developed using the HELGA framework. In figure 4 is shown the comparison between the models *GasSim*, HELGA and LandGEM.

Different types of waste contain different fractions of organic matter that degrade at different rates. The advantage of a multi-phase model is that the typical waste composition can be taken into account.

*Afvalzorg* is another multiphase model used to estimate landfill gas production from waste landfills. This model has the advantage of considering eight waste categories and three fractions. For each fraction landfill gas production is calculated separately [17].

*EPER model France* gives two approaches to estimate methane emissions from landfills. The operator can select the most suitable approach: methane emission estimates for landfill cells connected to a landfill gas extraction system using data of recovered landfill gas by the landfill operator and the landfill gas extraction efficiency and methane emissions estimates for landfill cells connected or not connected to a landfill gas extraction system using a multi-phase model and the landfill gas extraction efficiency.

The methane emission for landfill cells can be calculated with the equation [17]:

$$A = F \cdot H \cdot [\text{CH}_4] \quad (3)$$

where: A = recovered amount of methane [ $\text{m}^3 \text{CH}_4 \cdot \text{y}^{-1}$ ];

$F$  = extraction rate of landfill gas - LFG [ $\text{m}^3 \text{LFG} \cdot \text{h}^{-1}$ ];  
 $H$  = compressor yearly hours in operation [ $\text{h} \cdot \text{y}^{-1}$ ];  
 $[\text{CH}_4]$  = methane concentration in landfill gas [ $\text{m}^3 \text{CH}_4 \cdot \text{m}^3 \text{LFG}$ ].

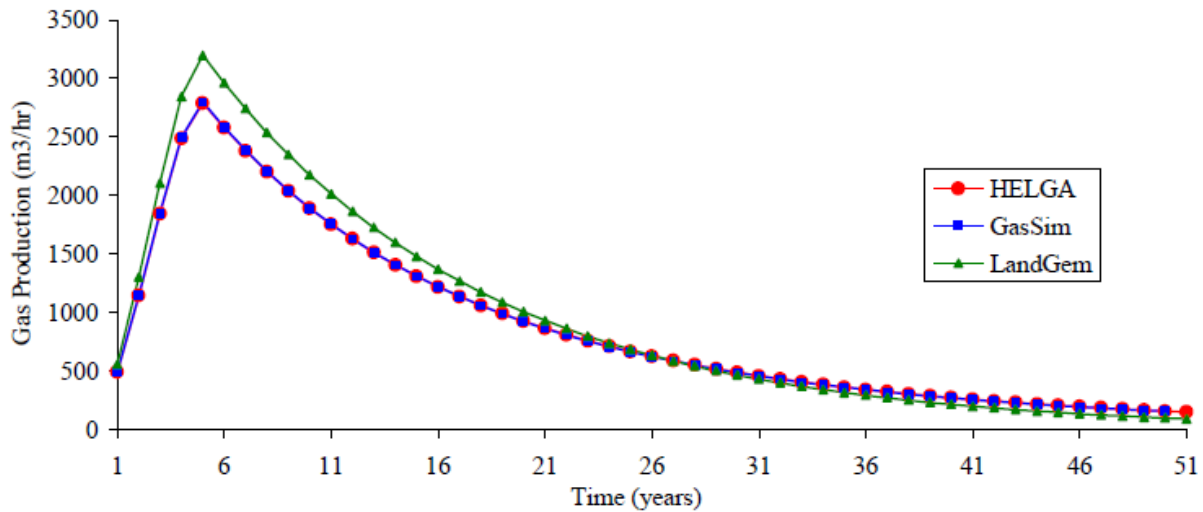

Figure 4: Comparison of GasSim, LandGEM and HELGA simulations [16]

#### 4. CONCLUSIONS

The most important stage in the design of landfill gas system is to know the amount of biogas that can be generate in the landfill site. Since methane has a higher global warming potential than carbon dioxide, production of methane is important in estimating the greenhouse gas emissions from landfilled waste. One of the most important parameter in assessing the methane generation potential is the waste components. Methane generation can be predicted using mathematical models. Most of these models were developed on Monod equation, and first – order kinetics are often used in methane production models, such as LandGEM, GasSim, Afvalzorg and EPER etc.

LandGEM is the most used automated estimation tool with a Microsoft Excel interface that estimate emissions rates for total landfill gas, methane, carbon dioxide, nonmethane organic compounds, and individual air pollutants from municipal solid waste landfills.

#### References

- [1] Dada, O., Mbohwa, C., *Biogas upgrade to biomethane from landfill wastes: a review*, Procedia Manufacturing, vol. 7, pp. 333-338, 2017.
- [2] Report from the Commission to the European Parliament, the Council, the European economic and social committee and the committee of the regions on the implementation of the EU waste legislation, <https://eur-lex.europa.eu/legal-content/EN/TXT/?uri=CELEX%3A52013DC0006>.
- [3] Yechiel, A., Shevah, Y., *Optimization of energy generation using landfill biogas*, Journal of Energy Storage vol. 7, pp. 93–98, 2016.
- [4] Pearce, L.F., Hettiaratchi, J.P., Kumar, S., *Towards developing a representative biochemical methane potential (BMP) assay for landfilled municipal solid waste – A review*, Bioresource Technology, vol. 254, pp. 312-324, 2018.
- [5] Rettemberger, G., *Evolution in landfill biogas management concepts*, pp.193-197, Sardinia Symposium – 30 th Anniversary Book, Ed. Cossu, R., Stegmann, R., 2017, ISBN 978-886-265-0113.
- [6] Lee, U., Han, J., Wang, M., *Evaluation of landfill gas emissions from municipal solid waste landfills for the life-cycle analysis of waste-to-energy pathways*, Journal of Cleaner Production, vol. 166, pp. 335-342, 2017.

- [7] Jaramillo, P., Matthews, H.S., *Landfill-Gas-to-Energy Projects: analysis of net private and social benefits*, Environ Sci Technol., vol. 39 (19), pp.7365-7373, 2005.
- [8] Augenstein, D., Pacey, J., *Modeling landfill methane generation*, Proceedings Sardinia 91, Third International Landfill Symposium, pp. 198-224, in Sardinia Symposium – 30 th Anniversary Book, Ed. Cossu R, Stegmann R., 2017, ISBN 978-886-265-0113.
- [9] Timoney, F., *Estimates of methane recovery in landfill gas flaring and utilisation*, EPA Climate Research Programme 2007 – 2013, Environmental Protection Agency, 2009, ISBN 978-1-84095-326-8.
- [10] Krause, M.J., Chickering, G.W., Townsend, T.G., Pullammanappallil, P., *Effects of temperature and particle size on the biochemical methane potential of municipal solid waste components*, Waste Management, vol. 71, pp. 25-30, 2018.
- [11] Liu, C-F., Yuan, X-Z., Zeng, G-M., Li, W-W., Li, J., *Prediction of methane yield at optimum pH for anaerobic digestion of organic fraction of municipal solid waste*, Bioresource Technology, vol. 99, pp. 882–888, 2008.
- [12] Emkes, H., Coulon, F., Wagland, S., *A decision support tool for landfill methane generation and gas collection*, Waste Management, vol. 43, pp. 307 – 318, 2015.
- [13] Kamalan, H., Sabour, M., Shariatmadari, N., *A review on available landfill gas models*, Journal of Environmental Science and Technology, vol. 4(2), pp. 79-92, 2011.
- [14] Alexander, A., Burklin, C., Singleton, A., *Landfill Gas Emissions Model (LandGEM), version 3.02 user's guide*, United States Environmental Protection Agency, EPA-600/R-05/047, May 2005, <https://www3.epa.gov/ttnca1/dir1/landgem-v302-guide.pdf>.
- [15] Lagos, A.D., Heroux, M., Gosselin, R., Cabral, A.R., *Optimization of a landfill gas collection shutdown based on an adapted first-order decay model*, Waste Management, vol. 63, pp. 238 – 245, 2017.
- [16] Attenborough, G.M., Gregory, R.G., Hall, D.H., McGoochan, L., *Development of a landfill gas risk assessment model: GasSim*, Available at <http://www.lqm.co.uk/uploads/general/files/GasSim%20SWANA%202002.pdf>.
- [17] Scharff, H., Jacobs J., Oonk, H., Hensen, A., *Methods to ascertain methane emission of landfills*, [http://www.afvalzorg.nl/Libraries/Publications\\_Methane\\_emissions/Paper\\_methods\\_to\\_asertain\\_methane\\_emission.sflb.ashx](http://www.afvalzorg.nl/Libraries/Publications_Methane_emissions/Paper_methods_to_asertain_methane_emission.sflb.ashx).

# OZONE AND NITROGEN OXIDES PRODUCTION IN STERILIZED TAP WATER BY AN OZONE GENERATOR TYPE OZONFIX 8G

Mirela Dincă<sup>1</sup>, Mariana Ferdeş, Gigel Paraschiv, Bianca – Ştefania Zăbavă,  
Nicoleta Ungureanu, Liviu Constantin  
University Politehnica of Bucharest, Romania

## ABSTRACT

The UV absorption spectra are important for understanding the composition of ozonated water. A commercially available ozone generator was used to obtain ozonated water by a bubbling method. A volume of 200 mL of sterilized tap water was treated with the gaseous mixture resulted from the ozone generator. The UV absorption spectra were recorded between 200 - 300 nm and the ozone concentration was determined by the iodometric method. The results showed that after 60 min of ozonation there are still present all the reactive species of O<sub>2</sub> and N<sub>2</sub>. This could explain also the strong decrease of pH values, after one hour of water ozonation. The iodometric analysis method showed the synthesis of some agents with strong oxidative potential, which can be both ozone and nitrogen oxides. The UV absorption spectra, concentration of ozone (g·L<sup>-1</sup>) determined by traditional iodometric method and the evolution of pH values were assessed.

## 1. INTRODUCTION

Disinfection is considered to be the primary mechanism for the inactivation/destruction of pathogenic organisms to prevent the spread of waterborne diseases to downstream users and the environment [1]. Ozone is an excellent disinfectant and can even be used to inactivate microorganisms such as protozoa which are very resistant to conventional disinfectants. Proper rate constants for the inactivation of microorganisms are only available for six species (*E. coli*, *Bacillus subtilis* spores, *Rotavirus*, *Giardia lamblia* cysts, *Giardia muris* cysts, *Cryptosporidium parvum* oocysts) [2]. The concentration of ozone which kills bacteria has been variously reported to be 0.04 to 0.1 ppm (volume), whereas the toxicity for small animals is 3 to 12 ppm [3]. Humans experience headache, and most people can detect the odor at 0.02 to 0.04 ppm. For ozone generation, there are four recognized methods: corona discharge, ultraviolet radiation, electrolysis and radiochemical method. The electrical discharge method is the most common energy source used to produce ozone. Extremely dry air or pure oxygen is exposed to a controlled, uniform high-voltage discharge at a high or low frequency. The gas stream generated from air will contain about 0.5 to 3.0% ozone by weight, whereas pure oxygen will form approximately two to four times that concentration [1].

A recent survey in Switzerland among water works that apply ozone has shown that for 90% of these plants the main reason for its application is disinfection [4]. Prabakaran M. et colab. have analyzed ozone treatment by applying to human pathogenic bacteria such as *Escherichia coli* and *Pseudomonas fluorescens*, *Salmonella typhi* and *Klebsiella pneumoniae*. Among the treated bacterial species, *E.coli* revealed high sensitivity to ozone treatment compared to other bacterial strains [5].

In the present paper, were evaluated physico - chemical changes produced in sterilized tap water through gas bubbling generated by corona discharge using an ozone generator type OZONFIX 8G.

---

<sup>1</sup>Splaiul Independentei 313, Sector 6, Bucharest, 0761938017, mirela\_dilea@yahoo.com

## 2. METHODOLOGY

### *Ozone production*

Ozone was produced by a mobile ozone generator type OZONFIX 8G, with the following characteristics: ozone production  $8 \text{ g}\cdot\text{h}^{-1}$ , power 16 W, air cooling, gas flow (measured)  $2.5 \text{ L}\cdot\text{min}^{-1}$ , used for air and water treatment. All the experiments were conducted at temperature of  $20 \text{ }^\circ\text{C}$ . Tap water was sterilized in an autoclave for 15 minutes at  $121 \text{ }^\circ\text{C}$ .

### *Methods*

The gas resulted from the ozone generator with a flow rate of  $2.5 \text{ L}\cdot\text{min}^{-1}$  was bubbled in a volume of 200 mL sterilized tap water in a 30 cm cylindrical vessel, through a ceramic frit with dimensions of  $3 \times 1.8 \text{ cm}$ , different times, between 1 minute and 1 hour. At these time intervals, water samples with a volume of 5 mL were collected. The pH was measured using a pH meter type InoLab Multilevel 1 and the UV absorption spectra were plotted between 200 and 300 nm, using a T92+ UV VIS spectrophotometer, PG Instruments with quartz cuvettes. There were collected samples from the same water volume, at intervals of 5 minutes for 1 hour after the ozone generator was stopped. Samples were also collected after one week of storage in a vessel hermetically sealed at room temperature.

For determination of the formed ozone and oxidizing agents in the liquid medium, the traditional iodometric analysis method was used [6]. The gas produced by the ozone generator was bubbled through the ceramic frit into 200 mL of 0.2 M KI solution in a cylindrical vessel, thus the height of the liquid was 15 cm. Generated ozone as well as any other oxidizing agents reacted with iodide to form iodine. Samples of 10 mL were taken after 30 seconds to 20 minutes. The solution with formed iodine is poured into the titration vessel, it is acidified by 1 mL of 2 M HCl and then it is titrated by 0.05 M  $\text{Na}_2\text{S}_2\text{O}_3$  solution until the decoloration. To make this reaction more sensitive, a starch solution is added before the end of the titration. The amount of ozone is determined from the consumed solution of thiosulfate (1 mL of 0.05 M  $\text{Na}_2\text{S}_2\text{O}_3$  solution corresponds to 1.2 mg ozone).

## 3. RESULTS AND DISCUSSION

The accumulation of ozone and nitrogen oxides was monitored for 1 hour by recording the UV absorption spectra and determining the absorbance values specific to ozone and nitrogen oxides at 205 nm (specific for nitrogen oxides) and 260 nm (specific for ozone). The absorption spectra for the first 15 minutes of water treatment with the gas produced by the ozone generator are shown in Figures 1 - 4.

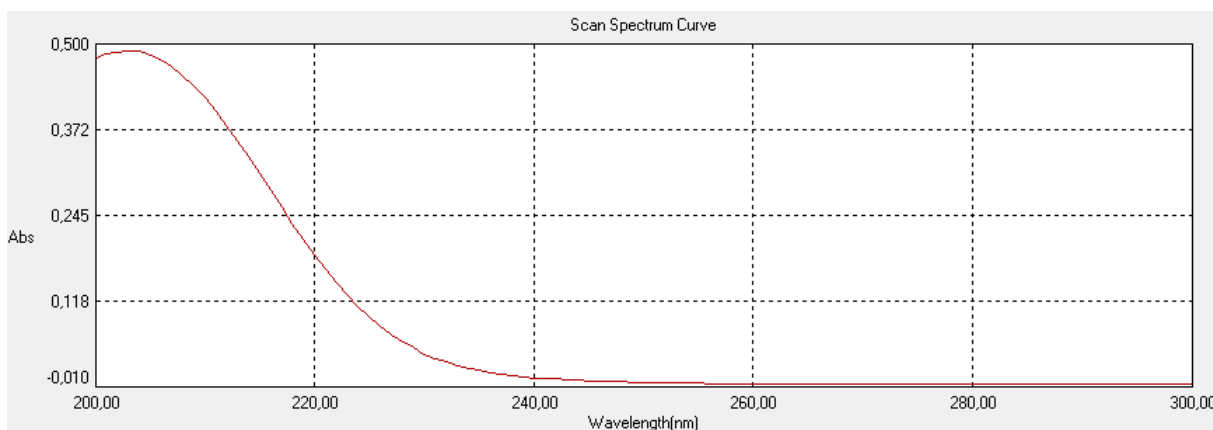

Figure 1: UV absorption spectra of ozonated water after 1 min

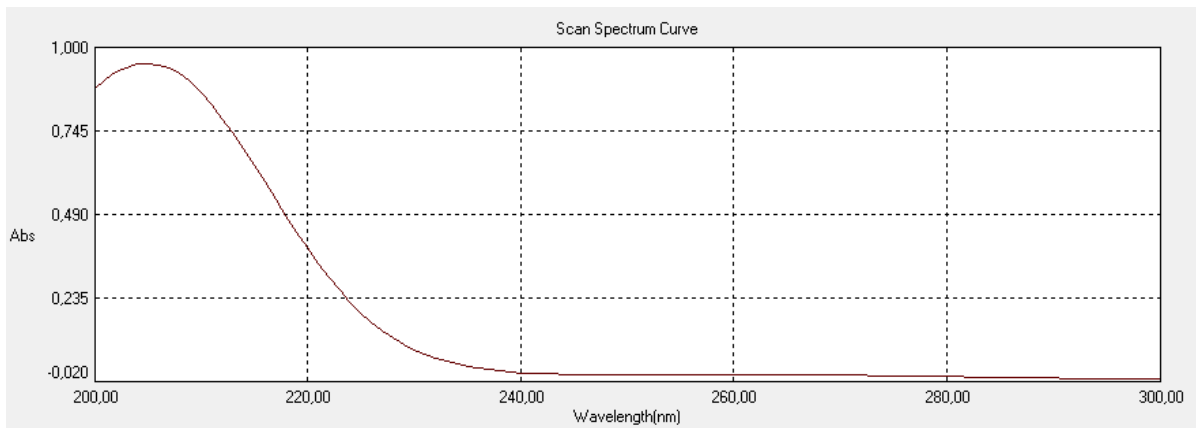

Figure 2: UV absorption spectra of ozonated water after 5 min

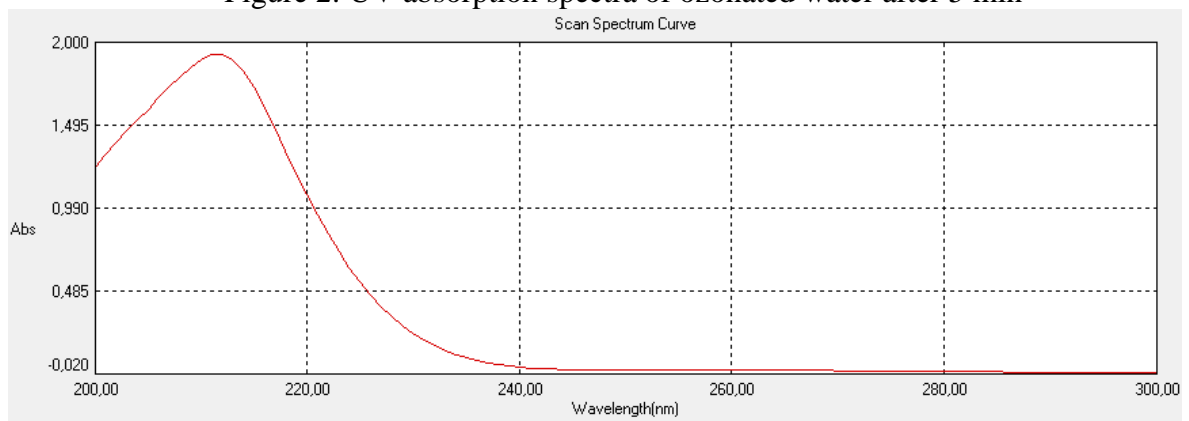

Figure 3: UV absorption spectra of ozonated water after 10 min

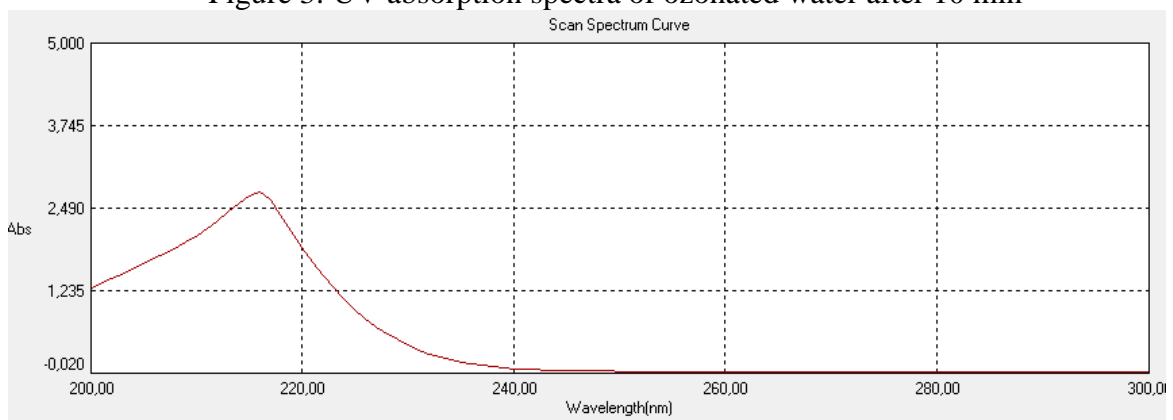

Figure 4: UV absorption spectra of ozonated water after 15 min

In figure 5, the absorption spectra for all samples taken at intervals of 1, 5,..., 60 min are shown. It is noted that for treatment times greater than 20 minutes, the absorbance values are greater than 10 units, which means that the reactive species of ozone and nitrogen oxides have a relatively high concentration. The absorption spectra in UV have demonstrated that the concentration of reactive species increases proportionally over time, reaching a value of 0.024 for ozone. Also, it was observed a shift in the maximum characteristic of nitrogen oxides to the right.

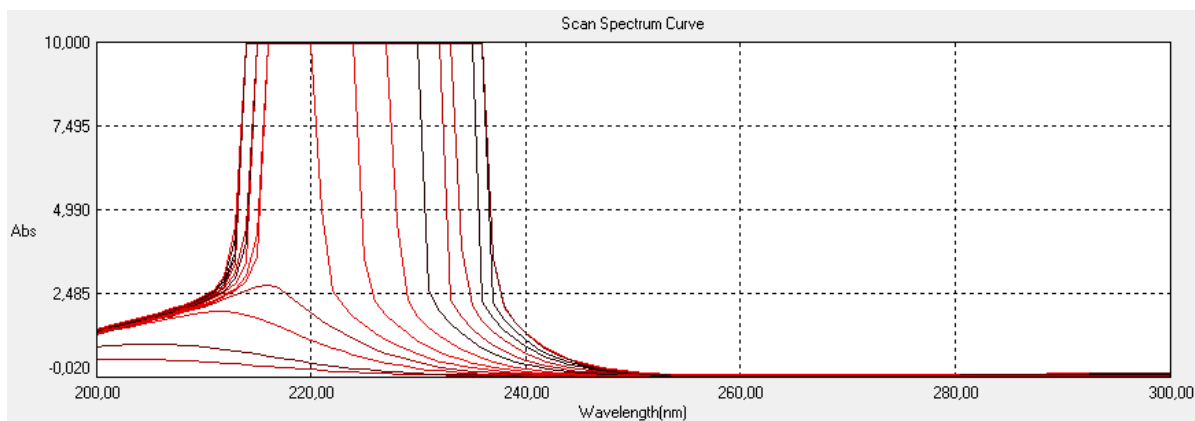

Figure 5: UV absorption spectra of ozonated water for 1 to 60 minutes

The absorbance values at 205 nm and 260 nm are shown at different times in Table 1.

Table 1: The absorbance values at 205 nm and 260 nm

Time [minutes]	205 [nm]	260 [nm]
1	0.483	0.00
5	0.953	0.00
10	1.592	0.00
15	1.635	0.00
20	1.655	0.003
25	1.682	0.005
30	1.708	0.005
35	1.734	0.008
40	1.749	0.010
45	1.775	0.014
50	1.799	0.017
55	1.817	0.020
60	1.828	0.024

In figure 6 it is noticed that although water ozone treatment was stopped, the absorbance values recorded at 5 minutes for one hour, for ozone and nitrogen oxides did not change significantly, and the graphs appear almost overlapped.

The presence of reactive species in sterilized tap water was tested also after a week of stored treated water, in a vessel hermetically sealed at room temperature. The water sample was diluted 1: 1000 and the absorption spectra were recorded between 200 and 300 nm as shown in figure 7. It is noticed that the reactive species are still present and their concentration seems to have not decreased.

In parallel with the absorption spectra in UV technique, the usual titrimetric method was used in order to observe the production of oxidizing agents.

The accumulation of ozone and possible oxidant agents in solution was monitored by the traditional iodometric method, depending on time. In figure 8 it is noticed that the accumulation of ozone and, eventually, of nitrogen oxides (resulted from the oxidation of atmospheric nitrogen entered into device) begins after the first 30 seconds. This aspect has been highlighted, also, by the fact that the 0.2 M potassium iodide solution started to become light yellow after this period. The ozone and nitrogen oxides showed an increasing concentration over time, reaching up to an equivalent value of  $1650 \text{ mg O}_3 \cdot \text{L}^{-1}$ .

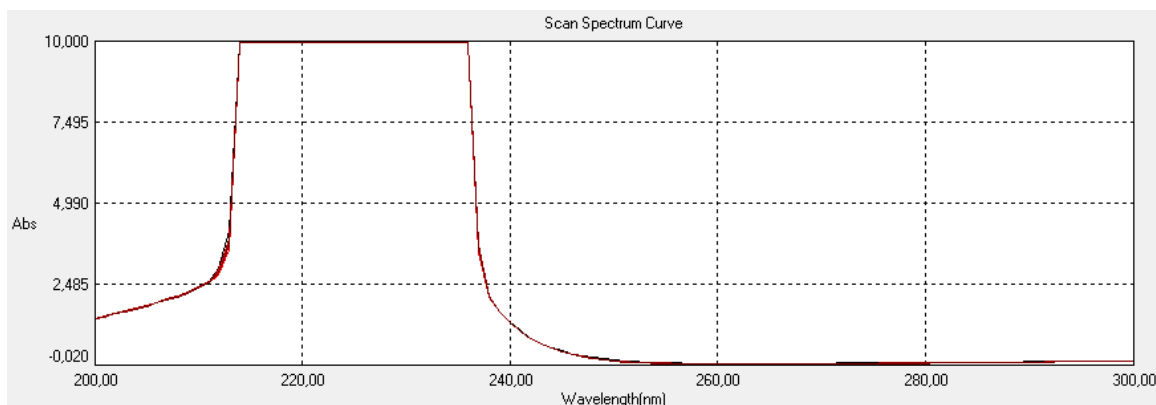

Figure 6: UV absorption spectra of ozonated water after ozone treatment was stopped

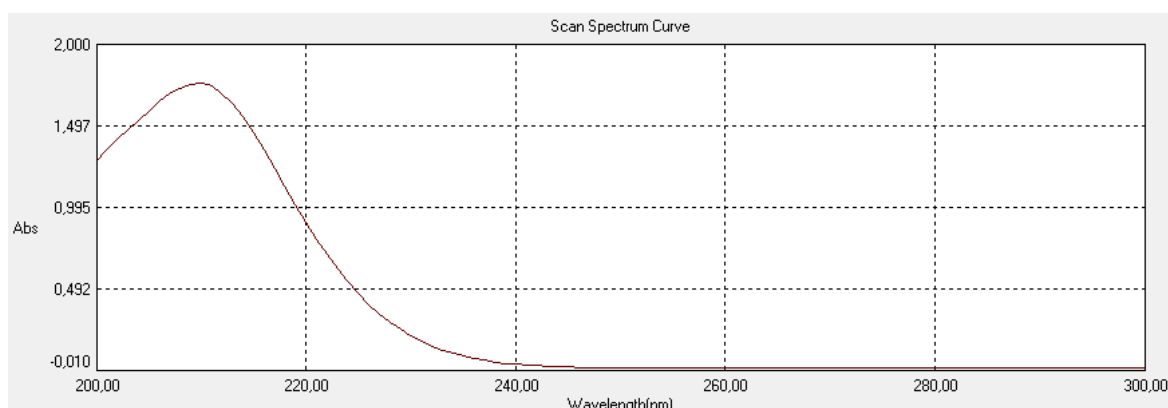

Figure 7: UV absorption spectra of ozonated water after one week of storage

After 20 minutes, the oxidation process was so strong that it determined the precipitation of  $I_2$  from the KI solution.

The main reactions that occur according to method are presented below [7]:



The high concentration of oxidants is explained by the characteristics of the device and by the low volume of KI in which the gas from the ozone generator was bubbled.

Taking into account the fact that the absorption spectra in UV are explained by nitrogen oxides formation, their accumulation in sterilized tap water probably as nitric acid was tested by recorded the pH values.

After gas bubbling in sterilized tap water, it was found that the pH decreases drastically from 7.4 units to 1.9 units after 60 minutes. The decrease is very pronounced in the first 5 minutes up to a value of 3.3 units, and then the decrease is slower (Figure 9). This is explained by the reaction of nitrogen oxides with water and the formation of nitric acid and other unknown acidic compounds. Thus, after 60 minutes from ozone generator stopped as well as after 1 week, the pH value maintained at 1.9 units.



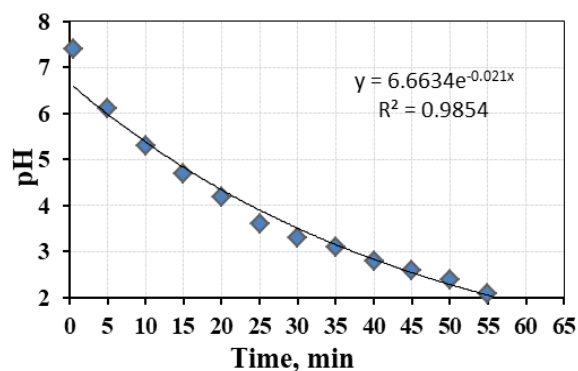
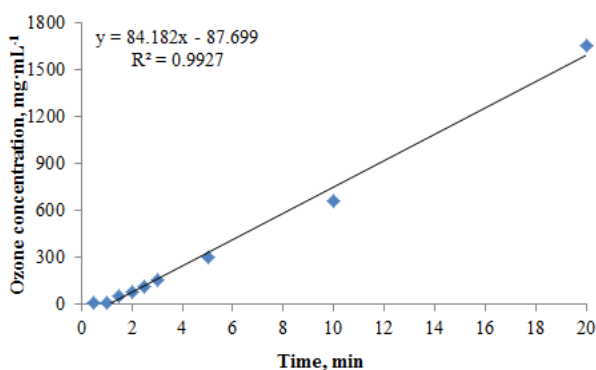

Figure 8: Variation of ozone concentration in time    Figure 9: pH values in ozonated water

## CONCLUSIONS

Using titrimetric method, high concentrations of oxidative compounds were found reaching a value of about  $1.6 \text{ mg}\cdot\text{mL}^{-1}$  expressed as ozone concentration.

The ozonated water contained high concentrations of nitric oxides and relatively low concentration of  $\text{O}_3$ , as determined in the UV absorption spectra between 200-300 nm.

Determination of pH values in ozonated water was in correlation with absorption spectra and suggests the presence of nitric acid and other acidic compounds formed after the treatment.

## References

- [1] U.S. Environmental Protection Agency (EPA). Office of Water Washington, D.C. EPA 832-F-99-063, September 1999.
- [2] Urs von Gunten. Ozonation of drinking water: Part II. *Disinfection and by-product formation in presence of bromide, iodide or chlorine*. Water Research. vol. 37, pp. 1469-1487, 2003.
- [3] McNair Scott, D.B., Leshner, E.C., *Effect of ozone on survival and permeability of Escherichia Coli*, Journal of Bacteriology, pp.567-576, 1962.
- [4] Courbat, R., Ramseier, S., Walther, J.L., Gaille, P., Jordan, R., Kaiser, H-P., Revelly, P., Stettler, R., von Gunten, U., *Utilisation de l'ozone pour traitement des eaux potables en Suisse*. Gas Wasser Abwasser, vol. 79, pp. 843-52, 1999.
- [5] Prabakaran, M., Selvi, S.T., Merinal, S., Panneerselvam, A., *Effect of ozonation on pathogenic bacteria*. Advances in Applied Science Research, vol. 3, pp. 299-302, 2012.
- [6] Oh, J.S., Yajima, H., Hashida, K., Ono, T., Ishijima, T., Serizawa, I., Furuta, H., Hatta, A., *In-situ UV absorption spectroscopy for observing dissolved ozone in water*. Journal of Photopolymer Science and Technology, vol. 29, pp.427-432, 2016.
- [7] International ozone association, Quality Assurance Committee, Revised Standardized Procedure 001/96, Iodometric method for determination of ozone in a process gas, Available at: <http://www.otsil.net/articles/iodimetry%20method%20of%20ozone%20measurement.pdf>.

# TECHNOLOGY FOR CULTIVATING BICOLOUR SORGHUM FOR FOOD OR ENERGETIC PURPOSES

Eng. Dumitru Iulian<sup>1)</sup>, PhD. Eng. Voicea Iulian<sup>1)</sup>, PhD. Eng. Vlăduț Valentin, PhD. Stud. Eng. Găgeanu Iuliana<sup>1)</sup>, PhD. Stud. Eng. Oprescu Remus<sup>1)</sup>, PhD. Stud. Eng. Persu Cătălin<sup>1)</sup>, PhD. Eng. Ungureanu Nicoleta<sup>2)</sup>, Eng. Balan Vică<sup>3)</sup>, M. Cristea<sup>4)</sup>  
<sup>1)</sup> INMA Bucharest, <sup>2)</sup> University Politehnica of Bucharest ,  
<sup>3)</sup> Mido Rom Electronic SRL, <sup>4)</sup> SC Cantarprod SRL

E-mail: dumitru.iulian2016@gmail.com

## ABSTRACT

Sorghum originates from Africa where it is grown for more than 3000, appearing in Europe around the 15<sup>th</sup>, and in Romania is grown for more than 50 years. Now, the large ranges of sorghum varieties that can be grown in our country can be used for producing sugar, vinegar, beer, juices, flours, alcohol, medicines, but also for producing biogas and bio-ethanol (ethanol is obtained from sweet sorghum syrup). Sorghum nutritive qualities and production costs recommend it as a good replacement for corn. Sorghum is a heat loving plant being able to easily withstand temperatures up to 40°C, the minimum germination temperature being over 10°C. Sorghum crops have high draught resistance, being able to survive low precipitation conditions and can be grown in types of soil where other plants have low yields. Sorghum crops can be both annual and perennial. For soil preparation, sowing, crop maintenance as well as for harvesting, sorghum requires the same range of equipment used for cereal crops. Seed sorghum is harvested when seeds reach maturity, using cereal harvesting machines, fodder sorghum is harvested using fodder harvesters when plants are 40÷50 cm tall, and for sorghum hay harvesting is done when the spikes appear. The paper presents an overview of technologies for the cultivation of bicolor sorghum crops for energetic and food purposes.

## INTRODUCTION

The sorghum is grown throughout the world and used for: food (flour, juice, syrup, vinegar, etc.) for animal feed in the form of pasture, hay, silo, pellets and last but not least in the industry for the production of fuels, energy, alcohols, textiles and plastics, paper, construction materials, brooms, brushes, wickerworks, building materials. Sorghum is a plant in the grass family Poaceae, monocotyledonous, with fasciculated root, the root system is strongly developed and can reach over 1m depth [5], spreading sideways to 1.5m [2, 4,1]. The stem reaches an average of up to 2.5 m [6] (there are different varieties that have a stem of 0.5 m while other varieties reach up to 6 m. [2, 4]) The stems can be dry or succulent. Juice from the sorghum stem can be sweet or insipid. [2]. The stems are made up of nodes and internodes, with an ear-like inflorescence [6]. Inflorescence can reach up to 60 cm long [2, 1] and a width of 5-25 cm [2, 3]. Some varieties have only one stem, but there are also sorghum variants with over 10 shoots. These shoots may grow sooner or later during the plant development process. [2, 4]. The leaves are alternately arranged, a single plant may have between 7 and 24 leaves depending on the variety [2, 4]. It is considered the fifth cereal crop worldwide after corn, rice,

---

<sup>1</sup> 6, Ion Ionescu de la Brad Blvd., e-mail: dumitru.iulian2016@gmail.com

wheat and barley. [6] Because it is resistant to drought, one of its main qualities, sorghum is also called:

- ✓ the cereal of the arid areas [8]
- ✓ the plant camel [7],
- ✓ the drought resistant corn, while in our country it has been given names such as:

little broom, corn for birds, sweet sorghum and even corn.

The largest producers are the USA, India, Nigeria, Australia and Argentina [9]. Among the different varieties of sorghum in the world we mention: sorghum alnum, sorghum amplum, sorghum angustum, sorghum arundinaceum, sorghum bicolor, sorghum brachypodium, sorghum bulbosum, sorghum burmahicum, sorghum ecarinatum, sorghum exstans, sorghum grande, sorghum halepense, sorghum interjectum, sorghum intrans, sorghum laxiflorum, sorghum leiocladum, sorghum macrospermum, sorghum matarankense, sorghum nitidum, sorghum plumosum, sorghum propinquum, sorghum purpureosericeum, sorghum stipoideum, sorghum sudanense (Sudangrass), sorghum timorense, sorghum trichocladum, sorghum versicolor.



Figure. 1 Sorghum varieties. a) Sorghum arundinaceum b) Sorghum alnum c) Sorghum halepense



Figure 2. Sorghum bicolor



Figure 3. Sorghum Sudanense [13]

The hybrid sorghum varieties produced at NARDI FUNDULEA (National Institute for Agricultural Research and Development Fundulea) include: F.32 and F.380-83 for grains, Tutova, Tinca, Tereza for green mass, sweet sorghum hybrids for biomass production Roza, Doina, Prut, Carmen and Fundulea.135 ST and the sorghum varieties for brooms Siret, Denisa and Donaris. [10]

Quebec is the first sorghum hybrid for grains approved in Romania, in 2005. It is produced by Rustica. It is a hybrid of the early precocity group and has a small plant height. It presents a medium-sized, red-orange panicle in its mature stage. It is resistant to fall, plant breakage and it has good tolerance to drought and heat. The production potential is over 12 tonnes/ha, and the MMB (mass of 1,000 grains) is about 31-34 g. [14] Fundulea 32 is a simple, semi tardy hybrid, with cream – brown grains, of high - performance, created at the National Institute for Agricultural Research and Development Fundulea). The hybrid has 140 cm plant height and increased resistance to drought, shaking, diseases and pests. The panicle is spiked and has a length of 20 - 21 cm, with 1900 - 2100 grains/panicle and MMB of 20 - 21 g. [14] Armida is an early hybrid, with white grains, of ultra-high performance, created by Euralis Semences SAS France. It is a semi-early hybrid, with zero tannin content. It is characterized

by the stay-green effect, the semi-open panicle, the very high resistance to drought and shaking, as well as the very rapid drying of the grains towards the end of the vegetation period. The yield potential of this hybrid reaches up to 11,000 kg/ha. [14]



Figure 6. Sorghum Armida crop [12]

In terms of panicle and grains morphology, sorghum consists of two types: with spiked panicle (such as *saccharatum*, *technicum* Fig. 7a) and compact panicle (such as the *sudanense* variety Fig. 7b)).



Figure 7 a). Sorghum saccharatum, technicum



Figure 7 b). Sorghum sudanense

[11]

From the life cycle point of view, there are sorghum varieties with a one-year (annual) life cycle and a smaller number of perennial varieties. [2, 4]. From the nutritional point of view, sorghum varieties are divided, based on the tannin content, in 3 categories:

1. Low tannin content : <0.2%,
2. Medium tannin content: 0.2-0.6%,
3. High tannin content:> 0.6% [16].

Sorghum is predominantly self-pollinated [2, 1]. Lately, in the world as well as in Europe, there is a lot of interest in the promotion of sorghum crops. In 2016, on November 3, the European Sorghum Congress was held in Bucharest and it was attended by experts on sorghum cultivation and capitalization.

## METHODOLOGY

Sorghum should not be absent from the crop rotation practiced on the sandy, alkaline and saline soils, or on the sloping lands, for its high adaptability to drought (transpiration coefficient = 158-274), alkalinity (pH = 5÷9) and soil salinity or from the prevention of deflation on sandy soils. In order to obtain a high production it is necessary to put this crop in a rational rotation, ensuring preplants that leave a weed clear land in order to avoid the danger of weeds growing during the plants' first stages of vegetation. In the culture areas favourable to sorghum, the best preplants are the straw cereals, sunflower, sugar beet and corn. Cultivating sorghum after perennial legumes or perennial grasses is not advisable because the maintenance works in the early stages of vegetation are carried out with increased difficulty as the root

fragments, both of the preplant culture (lucerne) and the perennial weeds, generate many shoots.

**Fertilisation.** In areas favourable to this culture, the use of fertilizers is directly conditioned by soil water. The degree of fertilizer utilization also depends on the type of soil. Administration of organic fertilizers proves to be effective, sorghum reacts favourably if the fertilization is carried out in autumn with 30÷40 t/ha of fermented manure. It should not be neglected that unfermented manure is a powerful source of weed growing, especially in irrigated or wetter areas. Sorghum requires a soil loosened to a higher depth, well-grinded, large water reserve and free of weeds. In order to meet the requirements of small seeds and the more difficult germination of this plant, increased attention will be paid to soil works. If the sorghum is cultivated after straw cereals, annual legumes, a deep summer plow at 28÷30 cm will be carried out, in aggregate with the stellar harrow. Its efficiency is higher if it is done immediately after harvesting the preplant, as it reduces water losses in the soil.

**Seed.** Quality indexes of sorghum seed depend largely on how it is preserved, the biological purity of populations and hybrids cultivated. In order to achieve the maximum germination capacity it is necessary to harvest the sorghum panicles at physiological maturity and dry them in suitable storage or storehouse so that the humidity of the grains is reduced to 10÷12%. In order to ensure the seed resistance at different pests or diseases a specific treatment will be applied.

**Sowing.** The sorghum sowing period is conditioned by the thermal regime of the different types of soils, knowing that this plant is very demanding for heat. The minimum germination temperature is 14÷15°C. Sowing too late has the disadvantage that the soil water reserve is diminished and the vegetation period is deferred too much in the dry season, which leads to a decrease in green mass production and creates the risk that the seeds will not reach physiological maturity until the first frosts in the autumn. In the years when climate conditions are normal in the south and southwest of the country, sorghum is sown in the last decade of April and the first decade of May, respectively 2÷3 days after the optimal sowing time of the corn for grains.

The sowing of sorghum at the optimum time also greatly contributes to the ease of maintenance works, especially the more vigorous weed control and the increase in the resistance to the attack of aphids and the infection with various bacterioses. The sowing depth is determined according to the granulometric composition and the soil water reserve. In the steppe regions it will be sowed at a depth of less than 4-5 cm, and in soils with sandy or sandy-loam texture it will be sowed deeper, at 5-6 cm. The plant density is conditioned by the size of the sorghum populations and hybrids, the fertility and the water regime of the different soil types. (Table 1)

Table 1 Sorghum density according to soil type, sorghum variety and irrigation conditions

Soil type	Non-irrigated				Irrigated			
	<i>Sorghum grains</i>	<i>Sweet sorghum</i>	<i>Sorghum x Sudan</i>	<i>Sorghum brooms</i>	<i>Sorghum grains</i>	<i>Sweet sorghum</i>	<i>Sorghum x Sudan</i>	<i>Sorghum brooms</i>
Normal	125÷175	100÷125	450÷500	100	225÷275	125÷150	600÷750	125÷150
Salty	80÷125	80÷100	300÷350	80	175÷200	100÷125	500÷600	100÷125
Sandy	75÷100	75÷80	250÷300	70	150÷175	100÷125	500÷600	100÷125

On the fertile land in the steppe area of our country, sorghum has been grown frequently at a density of 150÷200,000 plants harvestable per hectare. On less fertile land, the density was reduced to 100,000 plants harvestable per hectare.

The amount of seed required to ensure an optimal density of 160,000 - 200,000 plants harvestable per hectare is 8-10 kg/ha, if the germination is at least 90%. If the seeds have a weaker germination, seed quantities will be increased so as to ensure optimum density.

The use of large amounts of seed well above the calculated norm creates problems for the plant emergence, the consumption of labour, in order to ensure an optimal growth and development space, is exaggerated and economically unjustifiable.

#### **Sorghum crop maintenance works.**

Sorghum, the same as sorghum for grains, is one of the most pretentious plants in terms of maintenance works. At this plant there is a danger of the crop being compromised due to the soil crust and because of the weed growing after the sunrise, because of the low growth rate of the plants in the first vegetation phase. There is also the danger that young plants are strongly attacked by aphids. To prevent these shortcomings, all measures must be taken to ensure that the soil is as thoroughly prepared, ground and free of weeds. After sowing, rolling ensures a very good plant emergence. The sorghum is very demanding in the works of maintenance in the first 40÷45 days since the emergence due to the plant poor emerging power and the poor development power of the young plants.

After emergence, when the sorghum has 4÷5 leaves, up to the height of 15÷20 cm, the soil can be worked with rotating hoe, respecting some rules in its use (with the teeth turned) to avoid the danger of plant uprooting. The most important maintenance work for sorghum crop is the hoeing. Typically 2÷3 mechanical hoeing and 1÷2 hand hoeing passes are executed. At mechanical hoeing, to protect the sorghum roots of being cut, the protection area next to the plant row is left larger than in the case of corn. If the active parts cut off the lateral roots on the soil surface, the plants would be hindered to grow and develop. Also, the hand hoeing on the row must be done with great care not to damage the plants. In order to reduce the workforce, soil chemical weeding is used before sowing on the whole surface or on the row in the same time with the sowing work. In the case of aphids attack, aphid control is a mandatory measure when the attack is strong and it is achieved by treatments with organophosphorus products. At least two-times spraying are required at 10÷15 days. In case there is manual force, it is possible to carry out the work of removing the shoots from the sorghum plants, thus generating the vigorous growth and development of the plants and obtaining of high quality productions.

#### **Sorghum harvesting**

The varieties of sorghum hybrids must be selected so that the crop can reach the flowering stage in July and the ripe stage by October 15. Sorghum quality depends largely on the time of harvesting. For example, sorghum crops for juice should be harvested when the maximum amount of sugar is in the plant, with the highest percentage of sucrose. As the plant matures, the quality of the juice improves by increasing the sucrose percentage and lowering the glucose one. Increasing the percentage of sucrose gives the possibility to obtain sugar from this plant beside the syrup. In general, sorghum harvesting for juice takes place when the grains are already mature. The whole plant is used to extract the juice, after the panicles have been harvested at the last internode. Removing panicles with the last internode can be made mechanically and is necessary because they contain very little sugar and have some salts that give a bad taste to the juice. It is advisable for the stems to be cut as close as possible to the ground, since the lower internodes contain the largest amount of juice. Sorghum harvesting is generally mechanized. Depending on the type of cultivated sorghum and its use after harvesting, specific harvesting machines are used. If we want to obtain grains, in the first phase, sorghum seeds are harvested with straw harvesters. When the grain humidity reached 13-14%, they are threshed, then passed through the cleaning machines and then stored. If the sorghum stems are harvested, plant mass harvesters are used. The material resulting from the harvester as fragmented green mass is transported in order to obtain the products for which it was grown.

## CONCLUSIONS

Sorghum is a plant that needs to be given greater importance in the context of global warming and multiple uses in both human food, to obtain green energy, animal feed and industry. It is necessary to improve or modify existing technologies according to farmers' needs and resources. It is a plant of the future due to its special resistance to drought. Sorghum can become a new source of raw material for the production of bioenergy; in human food, sorghum has become increasingly used foodstuff, offering a great variety of uses going entering well into combinations with other food.

**Acknowledgement:** This work was supported by a grant of the Romanian National Authority for Scientific Research and Innovation, CNCS/CCCDI –UEFISCDI, project number **PN-III-P1-1.2-PCCDI-2017- 0566** (ctr. Nr. 9 PCCDI/2018- COMPLEX SYSTEM OF INTEGRAL VALUABILITY OF AGRICULTURAL SPECIES WITH ENERGY AND FOOD POTENTIAL, COMPONENT PROJECT 1 - DEVELOPMENT OF INNOVATIVE CULTIVATION TECHNOLOGIES FOR SPECIES WITH ENERGY POTENTIAL FOR BIOMASS).

## References

- [1] Balole, T. V.; Legwaila, G. M.; Brink, M.; Belay, G., editors. *Plant Resources of Tropical Africa 1. Cereals and Pulses*. Wageningen, Netherlands: Backhuys Publishers; 2006. p. 165–175
- [2] Jiří Hermuth, Dagmar Janovská, Petra Hlásná Čepková, Sergej Ust'ak, Zdeněk Stražil and Zdislava Dvořáková, *Sorghum and Foxtail Millet—Promising Crops for the Changing Climate in Central Europe*, Chapter 1, *World's largest Science, Technology & Medicine Open Access book publisher*.
- [3] Kimber, C. T. Origins of domesticated sorghum and its early diffusion to India and China. In: Smith, C. W.; Frederiksen, R. A., editors. *Sorghum: Origin, History, Technology, and Production*. USA: John Wiley & Sons, Inc.; 2000. p. 3–98.
- [4] National Research Council. *Lost Crops of Africa. Vol. 1. Grains*. Washington, DC: National Academy Press.
- [5] <http://www.referatul.ro/referate/sorgul-sorghum-bicolor-moench.html>
- [6] <https://ierburiuitate.wordpress.com/2014/02/20/sorgul/>
- [7] <https://www.revista-ferma.ro/articole/agronomie/paduchele-verde-al-cerealelor-inamicul-sorgului>
- [8] <http://www.incda-fundulea.ro/anale/75/75.8.pdf>
- [9] <http://agrintel.ro/5462/tufa-din-care-se-fac-maturile-mai-foloseste-la-biogaz-sau-ca-furaj-si-aduce-profit-pe-timp-de-seceta/>
- [10] <http://www.incda-fundulea.ro/anale/75/75.8.pdf>
- [11] <https://ierburiuitate.wordpress.com/tag/sorg/>
- [12] <https://www.stiriagricole.ro/tehnologia-de-cultivare-a-sorgului-una-dintre-cele-mai-bune-alternative-la-cultura-porumbului-in-zonele-secetoase-32420.html>
- [13] <https://ro.wikipedia.org/wiki/Sorg>
- [14] <https://www.stiriagricole.ro/tehnologia-de-cultivare-a-sorgului-una-dintre-cele-mai-bune-alternative-la-cultura-porumbului-in-zonele-secetoase-32420.html>
- [15] <http://www.incda-fundulea.ro/50ani/rezgen.html>
- [16] <http://www.sorghum-id.com/content/uploads/2017/09/1-2-cf-the-assets-of-sorghum-grain-in-feed-pptx-5.pdf>

# INVESTIGATION OF A DIGITAL HYDRAULIC ACTUATION SYSTEM FOR A WASTE BALING PRESS

Iulian-Claudiu DUȚU<sup>1\*</sup>, Sorin-Ștefan BIRIȘ\*, Edmond MAICAN\*,  
Paula TUDOR\*, Radu-Iulian RĂDOI\*\*

\* University Politehnica of Bucharest

\*\* Hydraulics and Pneumatics Research Institute, Bucharest

## ABSTRACT

Energy efficiency of modern industry machinery imply using adaptive electronic driving modules, based on digital processing units, in order to offer superior machine capabilities through firmware updating. It is a well-known fact that classic hydraulics installations mounted on industrial machinery are sometimes too complex and difficult to reconfigure and in some cases impossible. Industrial machines need to be flexible and energy efficient, leading to real challenges for industrial designers. Standardized hydraulics equipment and digital driving electronic modules are still a solution to modern industrial needs, but the energy efficiency is poor. Complexity of hydraulics installations has been, somehow, passed to electronics driving modules but led to a rapid increase in control system's complexity. Hydraulics manufacturing companies promote nowadays the concept of digital hydraulics systems as the answer to modern technical challenges. In this paper, the authors have investigated the possibility of using the digital hydraulics concept in replacing conventional electrohydraulic directional valves, in the case of a waste baling press. It will be underlined main advantages and disadvantages of digital hydraulics over classic hydraulics.

## 1. INTRODUCTION

Digital hydraulics technical concept has entered the international scientific community around 1999, as an alternative to classic hydraulic driving circuits using proportional or servo equipment. However, strong inertia of the scientific community made the concept to develop very slowly. In present, digital hydraulic valves are slightly to be found in the commercial offer of traditional hydraulic manufacturers, but there are several functional models ready to be delivered to the market. There are a few among large hydraulic manufacturers have technical knowledge and capabilities to produce custom digital hydraulics equipment. Research laboratories of universities or institutes are continuously trying to optimize existing valves, but the greatest challenge still remains the development of capable software control algorithms or proper adjustment of certain constructive parameters of valves or their electromagnets – depending on which technical solution is adopted. Digital hydraulics have two alternative solutions to classic equipment both having the benefit of reducing general energy consumption of the hydraulic driving system: high frequency PWM switching or parallel connection of several 2/2 hydraulic directional valves (very similar to valve-islands) electrically controlled independently. In the second case, the valves are smaller, having reduced installation and maintenance costs over proportional equipment. They are also robust. In P.E.T. waste presses, the main problem is energy management due to the fact that the hydraulic pumping module must always operate at almost full capacity. This means high energy consumption in normal operating mode even if there are certain functional phases that does not require so much energy. There are made some experimental studies (Finland) on a fully functional digital hydraulic equipment, mounted on an excavator boom that revealed an

---

<sup>1</sup>No. 313 Splaiul Independentei, 0040214029633, iulian\_claudiu.dutu@upb.ro



energy consumption reduction up to 70%, in some phases of the actuation cycle. In that case, digital hydraulics equipment was used to replace classic hydraulic LS (Load-Sensing) system of the excavator.

## 2. CURRENT STATE OF THE ART IN DIGITAL HYDRAULICS FIELD

The investigation starts from the idea of finding a technical solution to replace hydraulic proportional directional valves with new digital valve-islands, having equivalent operation principle, connected in parallel, with lower acquisition and maintenance costs, higher reliability and reduced overall energy consumption. It is a well-known fact that hydraulic proportional directional valves are expensive - looking, at least, from two points of view: acquisition and operation. This type of hydraulic valves are also very sensitive to the variations of some of the working environment parameters, but all of these have been somehow compensated using complex electronic modules and sensors. Furthermore, the reliability of hydraulic proportional valves is still a sensitive subject, referring mostly to the work cycle downtime, that in most cases require highly qualified personnel to diagnose and to repair – leading to increased personnel costs.

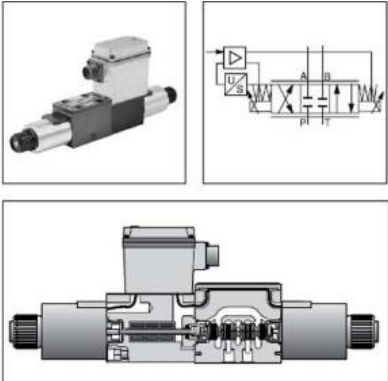

Figure 1: Proportional Directional Control Valve [14]

Hydraulic proportional directional valves are demanding continuous operation of the pumping module in order to compensate internal losses of the directional valves. Besides these considerations, it must be taken into account that in most cases hydraulic proportional directional valves demand supplemental anti-cavitation or compensation equipment which are expensive and have complex internal structure, contributing significantly to the overall energy consumption of the hydraulic driving system.



Figure 2: Digital hydraulics valve examples [3], [15], [16]

Digital hydraulics valves are simpler being materialized by parallel connection of 2/2 poppet valves. In theory, these type of hydraulic directional valves have zero losses, leading to the idea that is not necessary for the pumping module to operate continuously, reducing overall energy consumption. There is not needed anymore a large, complex and low-energy efficiency pumping module, where digital hydraulics valves can properly operate with smaller pumping modules having in their structure one or more hydraulic accumulators (pressure storage reservoir). From the start we can observe an improvement of the energy efficiency of the system.

Function	Directional valve	Flow control valve	Pressure relief valve	Pressure reducing valve
Hydro-mechanical				
Electro-hydraulic (closed-loop)				
Digital				

$\mu\text{P}$  = microprocessor  
 CE = control electronics

Figure 3: Equivalences between 2-way hydraulic valves, classic vs. digital [2]

Hydraulic 2/2 poppet valves, main components of the valve-islands, have small physical dimensions, they are robust and having lower acquisition, maintenance and operation costs than the proportional valves. Supposing that one of the poppet valves in the valve-island is not functional anymore, the automated electronic driving module will dynamically reconfigure the remaining operational valves of the valve-island in order to maintain process parameters near the setpoint values. Considering the case of hydraulic proportional directional valves, when one valve is defective, in most cases, the entire process will be shut down or can cause serious damages or life-threatening situations.

Main technical challenges encountered in the discussion classic vs. digital valves will be described in the following. The size of digital hydraulic valves is a delicate issue being approximated three times larger than regular hydraulic proportional directional valves. There is an obvious need for several parallel connected valves to make a valve-island in order to obtain the same operating function as in a hydraulic proportional directional valve [3]. A question arises over the reliability and cost factors of such a digital valve configuration. Being a relatively new concept, digital hydraulics equipment are highly priced and rare when referring to already existing models of hydraulic proportional valves. On long term this drawback will be overcome due to the benefits of mass production, but nowadays it is very important to take into consideration that digital hydraulics is a pioneering field of science and technology. Having a relatively large number of valves in the valve-island configuration that need to be controlled independently, it is required to develop a proper model control strategy,

directly dependent to the number of poppet valves in the valve-island. Considering that  $n$  is the number of parallel poppet valves in the valve-island configuration, there will be a maximum of  $2n$  possible control values for main digital valve's output. In the first place, main problem here will not be the value of  $n$ , but the speed of the electronic controller module when computing and trying to obtain an optimum combination of control values for a certain given state of the hydraulic system.

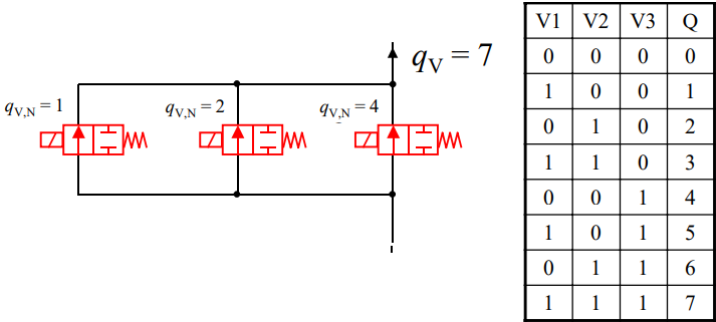

Figure 3: Example of a Digital Flow Control Unit (DFCU), hydraulics schematic and control coding [2]

There is a direct correlation between the value of  $n$  and valve's output, a large number of parallel valves in the construction of the digital valve result in a large range of possible output values, in the same time directly influencing the characteristic curve of the digital valve. The digital valve will always have an exact number of outputs that will always be obtained in the same conditions thus improving precision. Optimal control is also a delicate issue in digital hydraulics: when defining the objective functions it can be found that these are pursuing opposite goals, such as a short transient regime of the working pressures, higher output flow resolution, higher energy efficiency, lower market costs – still an important aspect due to the novelty degree of the digital hydraulics field (implying higher costs), lower noise and vibration generated by the poppet valves themselves, being in a continuous switching working regime – where the amplitude value of the switching noise is relatively close to the value of response time. Referring to the case of classic hydraulic proportional directional valves, the switching noise is given by the constructive particularities of those.

Probably one of the most important advantages of digital valves over classic valves is their programmability, meaning that same digital valve can be used for different purposes [2], by simply reprogramming its software controller. In the case of digital valves, available number of functions that a valve can perform depends mostly on the software than its mechanical structure. Control software can be easily updated to give new functionalities to the valve. This new concept of digital hydraulics, has the benefits of working in real time and hydraulic losses reducing, depending on the application, digital valve reduces losses 30-98% [2]. In the Figure below, it is shown a very short technological progress of the hydraulics field over the years. From the 1960's where the energy losses were significantly higher than the useful work, energy efficiency was at a maximum value of 10%, the technical field of hydraulics has progressed towards LS (Load Sensing) systems and officially starting from year 2006 towards Digital Hydraulics. A load-sensing hydraulic pump will always operate in a negative feedback control loop, establishing a new pressure drop every time the value of load pressure is changing.

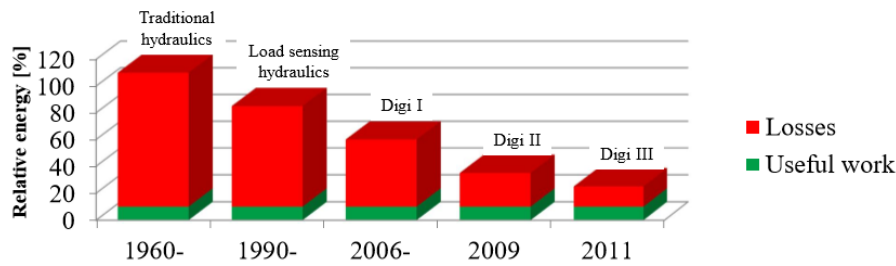

Figure 4: Relative energy usage in hydraulics [2]

Digital hydraulics has already encountered three phases of scientific and technical development, progressively reducing the energy losses, obtained through scientific research and laboratory experiments. Limitations of current approaches in the digital hydraulics field are directly related to the novelty degree of the thematic, causing in the same time an inertia in the scientific community, still adherent to classical hydraulics solutions. There are known very strong opinions that criticize the digital hydraulics field, on the difficulty to develop a highly intelligent control algorithms for digital hydraulics valves, on the limited valve resolution given by the limited number of directional valves in the valve-island, or on the still large physical dimensions vs. weight of the valve-islands or number of electrical wires and hydraulic hoses. The general trend of the industry is to miniaturize its equipment and digital hydraulics is not – nowadays – a part of that trend.

Some of the current technical approaches suggest instead of reinventing the field of hydraulics through digital hydraulics concept, to properly adjust the functional parameters of the existing hydraulic equipment available on the market, while promoting new functional models and intelligent control techniques in order to gain on the energy efficiency field. However, digital hydraulics tends to replace classic hydraulic circuits with their digital equivalent, using switching equipment and having significantly lower costs and higher efficiency. More or less, the limitations of the current approaches in digital hydraulics field are directly related to the costs of researches, still in the state of development and improvement, which implies the allocation of important funding of R&D departments of traditional hydraulic equipment manufacturers.

### 3. CONCLUSIONS

Current researches in the field of efficient P.E.T. waste pressing led to analyzing the idea of retrofitting a classic hydraulic baling press, using the digital hydraulics concept. Digital valve-islands made of 2/2 hydraulic directional valves seems to be a feasible solution over heavy and expensive load-sensing systems. The field of digital hydraulics is still in pioneering, researchers are still performing laboratory tests and formulating scientific hypotheses, their focus being on the development of optimal control strategies and valve development. Digital hydraulics can find the answer to some existing problems in hydraulics field, especially in energy efficiency and in the near future will replace available solutions. Still, digital hydraulics systems are using only one digital equipment in their configuration, such as directional valves, motors or pumps, and the others are classic or proportional equipment. When retrofitting an existing hydraulic system, fixed or mobile, it must be taken into account technical criteria such as available sensors, valves, power generators, functioning cycles, energy efficiency, control strategies, but also the economic criteria such as total cost control of the retrofitting and payback time. As a general conclusion, digital hydraulics has two strong advantages over classic hydraulics: energy efficiency and higher reliability.

#### 4. ACKNOWLEDGMENTS

This work has been funded by University Politehnica of Bucharest, through the “Excellence Research Grants” Program, UPB – GEX 2017. Identifiers: UPB-GEX2017, Ctr. No. 56 /2017 (DIGIPRESS) and UPB-GEX2017, Ctr. No. 106 /2017 (EFIHIST).

#### References

- [1] Boström, P., Matti Linjama, Lionel Morel, Lauri Siivonen, Marina Walden, *Design and Validation of Digital Controllers for Hydraulics Systems*, TUCS Technical Report, No 800, December 2006.
- [2] Linjama, M., *Digital Hydraulics*, Tampere University of Technology (TUT), Department of Intelligent Hydraulics and Automation (IHA).
- [3] Sethson, M., *The digital hydraulic challenge, to switch or not to switch*, Division of Fluid and Mechatronic Systems, Linköping University Sweden.
- [4] Linjama, M., & Huhtala, K., *Digital hydraulic power management system—towards lossless hydraulics*, Proceedings of the Third Workshop on Digital Fluid Power. pp. 13-14, 2010.
- [5] Dell’Amico, Al. et al., *Investigation of a Digital Hydraulic Actuation System on an Excavator Arm*, 13th Scandinavian International Conference on Fluid Power; June 3-5; Linköping; Sweden. No. 092. Linköping University Electronic Press, 2013.
- [6] Jelali, M., & Kroll, A., *Hydraulic servo-systems: modelling, identification and control*, Springer Science & Business Media, 2012.
- [7] Cristescu, C., Dumitrescu, C., Vrânceanu, G., Dumitrescu, L., *Considerations on energy losses in hydraulic drive systems*, ”Hidraulica” Journal, ISSN 1453-7303, Romania, No.1, pp.36-46, 2016.
- [8] <http://www.hydraulicspneumatics.com>
- [9] <http://www.directindustry.com>
- [10] \*\*\*<http://www.valmet.com>, *Digital Hydraulics, Technical Paper Series*, U.S.A., March 2016, accesat în April 2017.
- [11] <https://eu.hsm.eu>
- [12] Linjama, M., Paloniitty, M., Tiainen, L., Huhtala, K., *Mechatronic Design of Digital Hydraulic Micro Valve Package*, Procedia Engineering, Elsevier, vol. 106, pp. 97 – 107, 2015.
- [13] Linjama, M., Huova, M., Bostöm, P., Laamanen, A., Siivonen, L., Morel, L., Walden, M., Vilenius, M., *Design and Implementation of Energy Saving Digital Hydraulic Control System*, Vilenius, J. & Koskinen, K.T. (eds.) The Tenth Scandinavian International Conference on Fluid Power (SICFP’07), May 21-23, Tampere Finland, 2 , pp. 341-359, 2007.
- [14] <https://www.hydradynellc.com/product/d1fxe01ckndj00/series-dfx>
- [15] <http://www.tut.fi/interface/articles/2009/1/hydraulics-enters-the-digital-age>
- [16] <http://hightech.dimecc.com/results/digital-hydraulics-in-paper-machine-lines>

# MOTOR WHEEL MODELLING OF A TRACTOR

Duțu Mihaela Florentina<sup>1</sup>, Begea Mihaela, Duțu Iulian Claudiu,  
Cîrîc Alexandru, Simion Gabriela  
University Politehnica of Bucharest

## ABSTRACT

The article presents the MathCAD engine modeling of the tractor wheel for two types of tires used on the U-650M tractor, one manufactured in Romania and one manufactured by Good Year. The paper presents the characteristics of these two types of wheels studied. For these, they studied the oscillations of the engine wheel for slow and fast speeds of the tractor on agricultural land.

## 1. INTRODUCTION

The tractor is a complex mechanical system in which vibrations are transmitted from the track to the driver of the tractor during the movement. The vibration level determines the degree of comfort of the tractor driver and normal wheel reactions. [1]

Disturbances in the trailer suspension system caused by the terrain micro-plot have a random character. These perturbations can be considered to vary according to laws close to the period. Runway irregularities give rise to shocks on wheels, shocks that are transformed into oscillations by means of tires. After studying the model with a degree of freedom of the tractor wheel, a modeling program for the tractor engine wheel in MathCAD was developed. [7]

The following paper presents the modeling of two motor wheels used on the U-650M tractor, a tire wheel made in Romania and a Good Year tire wheel.

## METHODOLOGY

Using the modeling program, two engine wheels used on the U-650M were analyzed, namely:

- a tire motor made in Romania;
- a Good Year tire engine wheel. [3]

For each engine wheel, for the 1.2 bar pressure and 12000 N load, the ground contact surface, free wheel radius, radial deformation and lateral deformation were measured. The results obtained are shown in Table 1.

From the experimental data presented in Table 1 it results that the contact surface between the wheel and the ground, measured by planimetry, is higher for the wheel produced in Romania, the radial and lateral deformation being higher than for the Good Year wheel.

---

<sup>1</sup>Spl.Independentei, no.313, sect.6, Bucharest, 0214029637, dutumihaelaflorentina@gmail.com

Table 1: Characteristics of the engine wheels studied

Tire	Pressure [bar]	Load [N]	Surface support [cm <sup>2</sup> ]	Free beam [m]	Radial deformation		Lateral deformation	
					[mm]	[%]	[mm]	[%]
16,9 – 38 Romania	1,2	12000	1470	0,838	33,2	3,96	37	8,5
16,9 – 38 Good Year	1,2	12000	1365	0,838	27,3	3,25	12	2,8

The elastic constants ( $k$ ) and the damping coefficients ( $c$ ) for the two engine wheels are:

- engine wheel Romania:  $k = 350700\text{N / m}$ ;  $c = 8000$ ;

- Good Year:  $k = 427300\text{N / m}$ ;  $c = 8827$  .

The tractor wheel modeling program was run for the slow and fast speeds of the U-650M tractor for both types of runways: farmland and country road.

The tractor speeds are:

- slow speeds:

$$v_1 = 2,58 \text{ km/h}$$

$$v_2 = 4,16 \text{ km/h}$$

$$v_3 = 5,78 \text{ km/h}$$

$$v_4 = 7,68 \text{ km/h}$$

$$v_5 = 18,18 \text{ km/h}$$

- fast speeds:

$$v_1 = 3,83 \text{ km/h}$$

$$v_2 = 6,17 \text{ km/h}$$

$$v_3 = 8,56 \text{ km/h}$$

$$v_4 = 11,38 \text{ km/h}$$

$$v_5 = 26,94 \text{ km/h}$$

The characteristics of the agricultural land are:

- The height of the irregularities  $h_0 = 0,025 \text{ m}$
- lungimea neregularităților  $l = 0,208 \text{ m}$ .

The profile of the track for slow tractor speeds is shown in Figure 1.

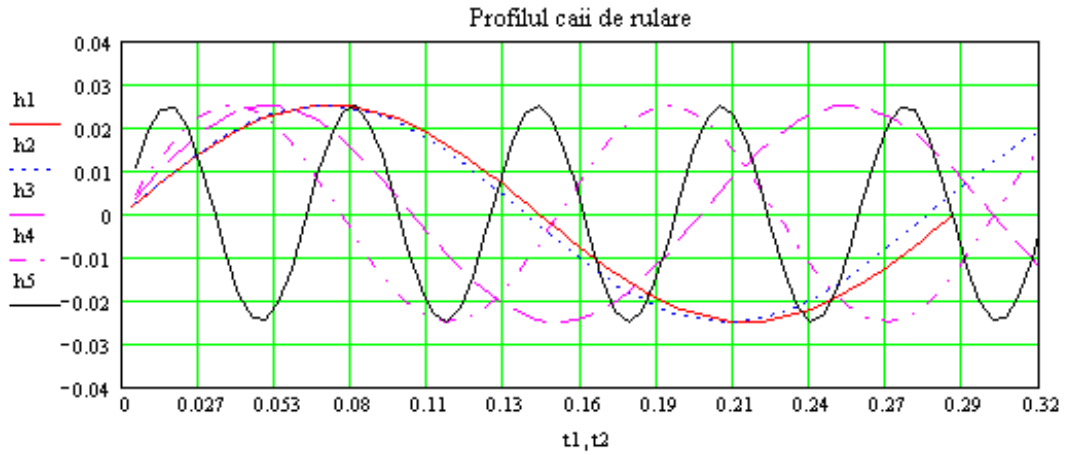

Figure 1: The agricultural land profile for the slow speeds of the U-650M tractor

The displacement of the engine wheel manufactured in Romania is shown in Figure 2 and the Good Year wheel in Figure 3.

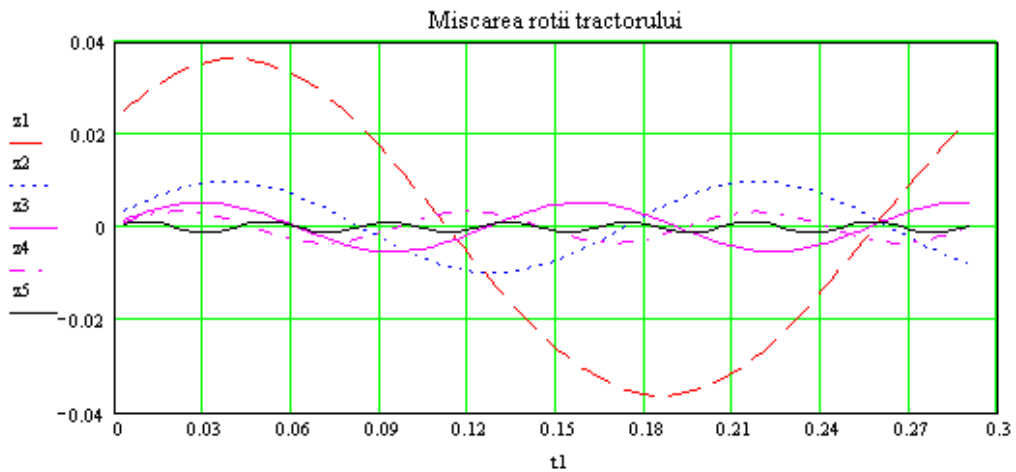

Figure 2: Oscillation of the engine wheel manufactured in Romania on agricultural land and slow speeds

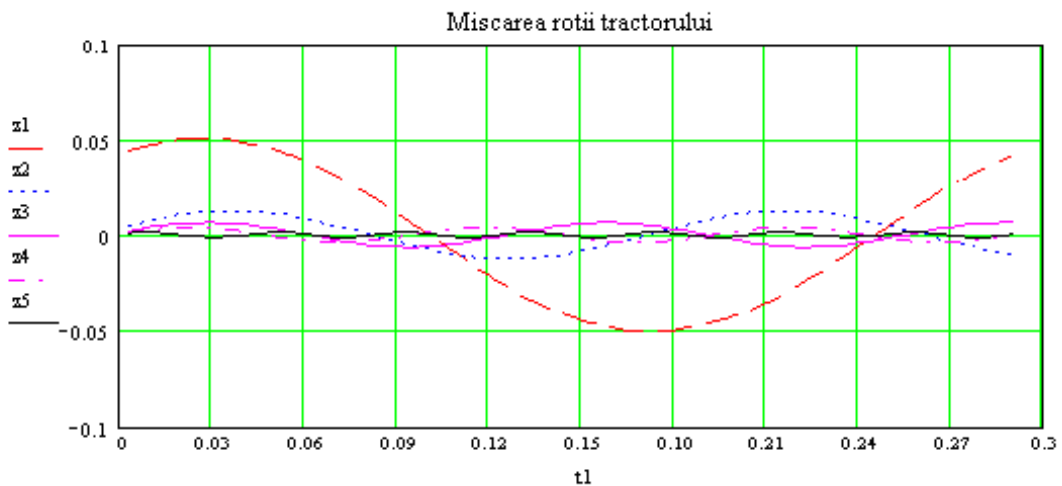

Figure 3: Oscillation of the Good Year engine wheel on farmland and slow speeds



For the fast speeds of the tractor, the profile of the tread pattern is shown in Figure 4.

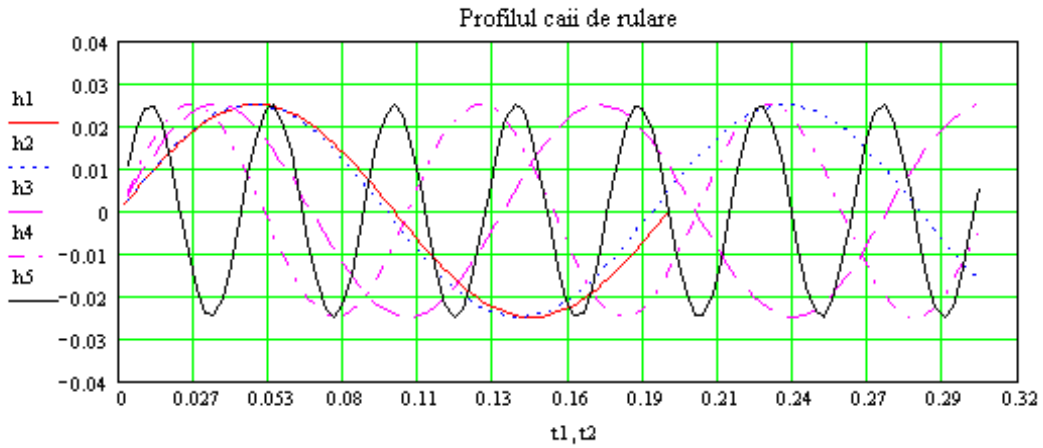

Figure 4: The agricultural land profile for U-650M tractor speeds

The oscillatory motion of the engine wheel manufactured in Romania when traveling on the agricultural land with the fast speeds of the U-650M is shown in Figure 5, and for the Good Year engine wheel in Figure 6.

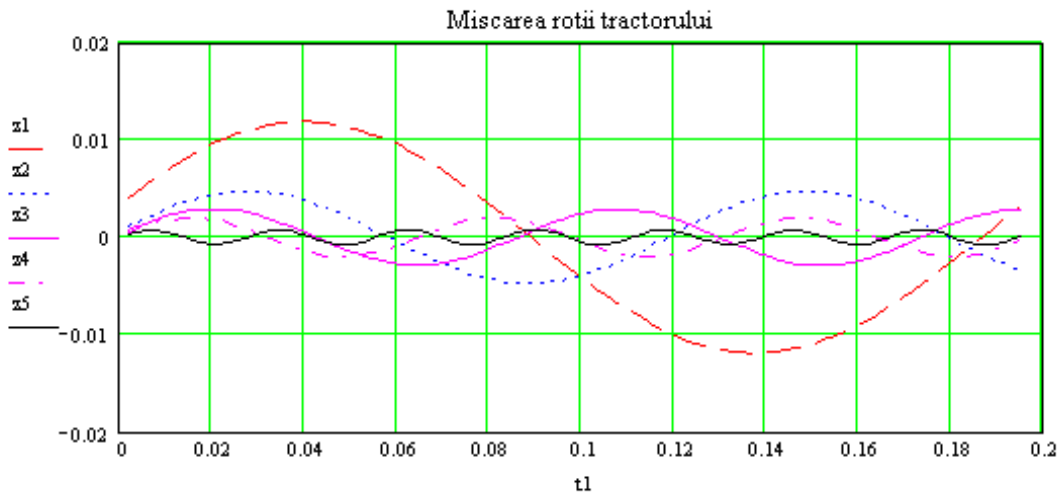

Figure 5: The oscillation of the engine wheel made in the country on agricultural land at the fast speeds of the tractor

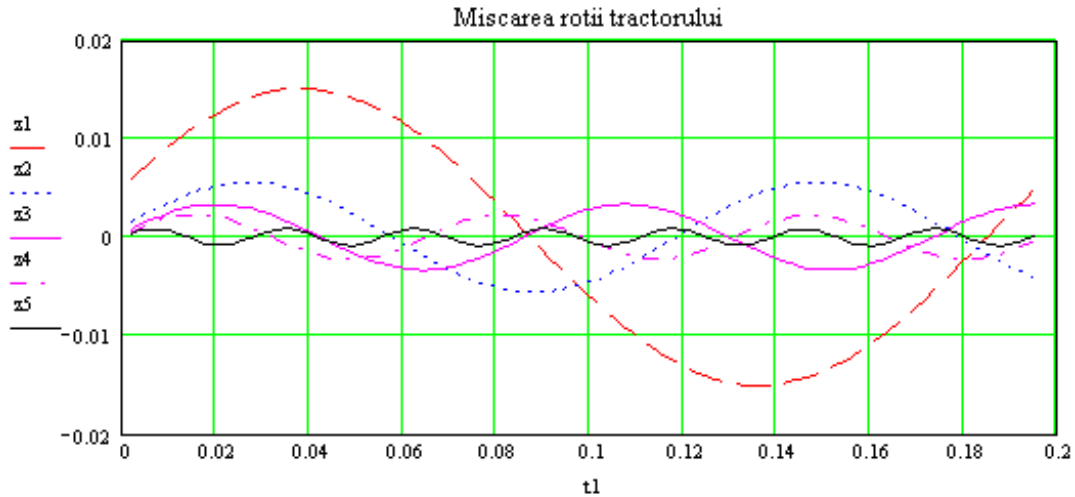

Figure 6: Oscillation of the Good Year engine wheel on farmland at the fast speeds of tractor

### 3. CONCLUSIONS

When moving the U-650M slow engine speeds, it is noted that the oscillation amplitude is higher for the Good Year wheel at the minimum speed  $v = 2,8 \text{ km/h}$ , and for the other four speeds, the oscillations amplitudes of the two tested wheels are very close. Running the modeling program for  $v_{\min} = 2,58 \text{ km/h}$ ,  $v_{\max} = 26,94 \text{ km/h}$ , for the two types of wheels, shows that the wheel oscillations produced in Romania are smaller than the Good Year at the minimum speed and are identical for the maximum speed (Figure 7).

In Figure 7,  $z_1$  and  $z_2$  represents the elongation of the engine wheel oscillations manufactured in Romania for the minimum and maximum speeds, and also  $z_{11}$  and  $z_{12}$  the elongations of the Good Year for the minimum or maximum speed respectively.

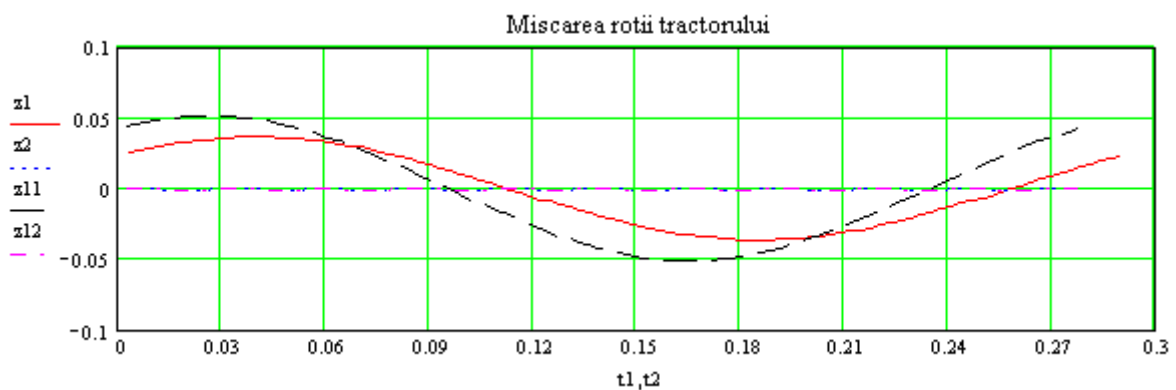

Figure 7. Comparison of engine wheel oscillations on agricultural land

The variation of the amplification factor (B) for the country-produced engine wheel and (B1) for the Good Year engine wheel according to the speed of travel on the agricultural land is shown in Figure 8.

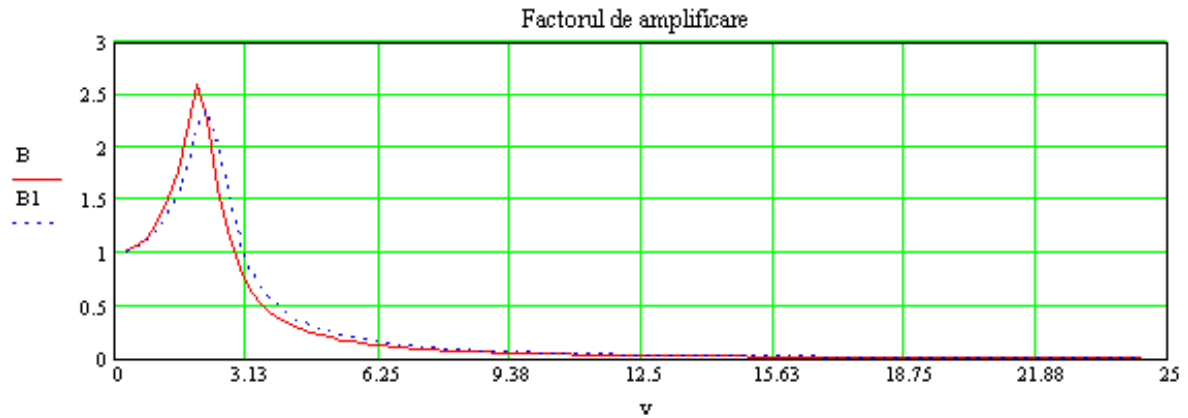

Figure 8. Variation of the speed-dependent amplification factor for the two types of motor wheels when traveling on farmland

It can be seen that the maximum value of the amplification factor is obtained for the minimum travel speed ( $B = 2,6$  for the country-made wheel and  $B_1 = 2,3$  for the Good Year wheel) and for the other speeds the values are close and very low.

### References

- [1] Bratu P. – Mecanică teoretică, Editura Impuls, București, 2006.
- [2] James M.L., Smith G.M., Wolford J.C., Whaley P.W. – Vibration of Mechanical and Structural Systems with Microcomputer Applications, Harper and Row, New York, 1989.
- [3] Jolobeanu C., Roșă I – MATHCAD. Probleme de calcul numeric și statistic, Editura Albastră, Cluj-Napoca, 1995.
- [4] Magheți I., Savu M. – Vibrații mecanice – teorie și practică, Editura Bren, București, 2004.
- [5] Munteanu M. – Introducere în dinamica oscilațiilor solidului rigid și a sistemelor de solide rigide, Editura Clusium, Cluj-Napoca, 1997.
- [6] Munteanu M. – Introducere în dinamica oscilațiilor solidului rigid și a sistemelor de solide rigide, Editura Clusium, Cluj-Napoca, 1997.
- [7] Scheiber E., Lixândriou D. – MathCAD prezentare și probleme rezolvate, Editura Tehnică, 1994.

# THE GROWTH BEHAVIOR OF *E. COLI* K12-MG1655 AND THE CONSUMPTION OF THE SUBSTRATE IN DIFFERENT SUGAR CONCENTRATIONS CULTURE MEDIA

Mariana Ferdes<sup>1</sup>, Mirela Dinca, Bianca Zabava, Gigel Paraschiv  
University "Politehnica" of Bucharest

## ABSTRACT

*Escherichia coli* K12-MG1655 was cultivated in minimal media containing different concentrations of glucose, at 27 °C, on an orbital incubator, at 150 rpm. The growth curves demonstrated that the OD at 600 nm correlated to the cell density depends on the concentration of the carbon source, being higher for 1% and 0.5% glucose. The exponential phase stops after 10-12 hours for the lowest concentrations of glucose (0.02% and 0.05%) and continues for up to 16-17 hours for the highest concentrations, that can be explained by the nutrient limitation. The results of glucose consumption showed a slow decrease in glucose concentration for the first 4-5 hours corresponding to lag phase of growth. In the next 10 hours, the glucose consumption is high, and after 14 hours the concentration of this nutrient decreases to 1.5% after 11 hours for the initial concentration of 0.05%, and to 6% after 14 hours for 0.1% initial concentration of glucose.

## 1. INTRODUCTION

A major goal for the food processing industry is to provide safe, wholesome and acceptable food to the consumer, and the control of microorganisms is essential. The control is exerted through processing and preservation techniques which eliminate microorganisms or prevent their growth [1].

Microbiological quality is among key attributes to indicate integrity of food products and hygiene of food processing [2]. Lack of proper hygiene and using low quality raw materials cause high presence of food-borne pathogens in food products [3].

Approximately 200 foodborne illnesses are recognized worldwide, but enterohemorrhagic *Escherichia coli* (EHEC) is considered among the most important bacterial pathogens to date. EHEC was recognized as a human pathogen in 1982, and still remains important to clinicians, researchers, and the general public [4, 5].

*E. coli* can contaminate food originating from warm-blooded animals and can be found in milk and dairy products, meat products, and different food products containing milk and meat [6].

The bacteria belonging to the species *Escherichia coli* are commonly found in the intestinal microflora of human and animals and are recognized as non-pathogenic microorganisms. However, some strains may become opportunistic pathogen and cause disease such as different diarrheal diseases, wound infections, meningitis, septicemia, arteriosclerosis, hemolytic uremic syndrome and immunological diseases [7].

*Escherichia coli*, which is ubiquitous in the environment, is considered a global indicator of fecal pollution [8]. *E. coli* is a cause of foodborne illness and its infection often

---

<sup>1</sup>University Politehnica of Bucharest, 0729821256, marianaferdes@yahoo.com

leads to hemorrhagic diarrhea, and occasionally to kidney failure, especially in young children and elderly [9]. *E. coli* are non-pathogenic in normal conditions, but if present in excess, will become causative agent of various diseases like urinary tract infection, diarrhoea, vomiting etc. [10]. *Escherichia coli* are the most commonly present bacterium in the human intestine, which helps in preventing the entry of pathogenic microorganisms [10, 11]. Shiga toxin producing *Escherichia coli* is one of the most common cause of food-borne diseases in the world [12].

*E. coli* is a Gram-negative, non-sporulating, flagellated, rod-shaped and facultative anaerobic bacterium of the *Enterobacteriaceae* family [13]. *Escherichia* comprises cells in the form of straight rods (1 x 3 µm), motile or nonmotile, mesophile. It is found in the intestinal contents of humans, warm-blooded animals, and birds. Many strains are nonpathogenic, but some strains pathogenic to humans and animals and involved in foodborne diseases. Among the classes of pathogenic *E. coli*, EHEC is perhaps the most important because of its virulence and its association with life-threatening complications such as hemolytic uremic syndrome. [14, 15].

The ability of microorganisms (except viruses) to grow or multiply in a food is determined by the intrinsic factors and extrinsic environment of food, respectively. Intrinsic factors of a food include nutrients, growth factors, and inhibitors (or antimicrobials), water activity, pH, and oxidation-reduction potential [14, 16]. Temperature is also an important extrinsic factor affecting microbial growth and, consequently, the safety of food [17] Microbial growth is accomplished through the synthesis of cellular components and energy. The necessary nutrients for this process are derived from the immediate environment of a microbial cell and, if the cell is growing in a food, it supplies the nutrients. These nutrients include carbohydrates, proteins, lipids, minerals, and vitamins.

Foods from plant sources are rich in carbohydrates but can be poor sources of proteins, minerals, and some vitamins. All microorganisms normally found in food metabolize glucose, but their ability to utilize other carbohydrates differs considerably. This is because of the inability of some microorganisms to transport the specific monosaccharides and disaccharides inside the cells and the inability to hydrolyze polysaccharides outside the cells [14]. *E. coli* can be grown in a minimal medium containing only an organic carbon source such as glucose and a source of nitrogen such as (NH<sub>4</sub>)<sub>2</sub>SO<sub>4</sub> and other minerals [18].

## 2. METHODOLOGY

### **Bacterial strain**

*E. coli* K12-MG1655 belonging to the Culture Collection of Microbiology Laboratory, Faculty of Biotechnical Systems Engineering, was cultivated in tubes on Luria Bertani agar medium and kept in refrigerator until use.

### **Inoculum**

Standardized inoculum was prepared from a single colony of *E. coli* after growing in Petri dishes. For growth experiments, a standardized inoculum of 2% (v/v) from a liquid culture prepared into Luria Bertani medium, 16-20 hours old (with OD 600nm of 1.4-1.9) has been used. The inoculum was grown in Erlenmeyer flasks, at 27 °C, on an orbital incubator, at 150 rpm.

### **Culture media**

The bacterial strain was cultivated in a minimal liquid medium containing glucose as sole carbon source, macro and microelements with the following composition: Na<sub>2</sub>HPO<sub>4</sub> 6g/L, KH<sub>2</sub>PO<sub>4</sub> 3g/L, NaCl 5g/L, NH<sub>4</sub>Cl 1,0g/L, Tween 80 1 ml/L, autoclaved at 121 °C for 15 min. 2ml of 1M MgSO<sub>4</sub> (2mM) (sterile filtered, on 0.22 µm membrane) and different volumes of 20% glucose (sterile filtered, on 0.22 µm membrane) were added after cooling. The second

solution, containing low concentrations of salts with the formula: 5g EDTA, 0.8g FeCl<sub>3</sub>, 0.05g ZnCl<sub>2</sub>, 0.01g CuCl<sub>2</sub>, 0.01g CoCl<sub>2</sub>, 0.01g H<sub>3</sub>BO<sub>3</sub>, 1.6g MnCl<sub>2</sub>, with pH 7.0 was sterilized by membrane (0.22 µm pore) filtration and kept chilled. Before use, this stock solution was diluted x100 in distilled sterile water.

**Methods.** Cultures were grown in minimal medium comprising different concentration of sugar (0.02%; 0.05%; 0.1%; 0.2%; 0.5% and 1%), at 27 °C, on rotary incubator, at 150 rpm, for 18 hours, at 27 °C. From hour to hour, the samples were analyzed for OD at 600 nm, and glucose concentration. Glucose analysis was done using a Glucose Colorimetric Assay Kit, QuantiChrom from BioAssay Systems. The analysis of total number of survival cells was performed in Petri dishes on Luria Bertani agar medium.

### Results and discussion

The growth curves for different concentrations of glucose presented in figure 1 are characterized by the specific phases for multiplication of bacterial cells in liquid medium.

The first growth phase, namely lag phase, takes 3 or 4 hours, the necessary time for cells to adapt to the new conditions of culture. For all the six concentrations of glucose, this phase seems to be the same. The values of optical densities are low, due to the small number of the cells. Because the minimal medium is different from the inoculum medium (that is Luria Bertani), the enzymes are forced to use new type of nutrients.

In the second phase, the exponential phase, when bacterial cells are growing and dividing at the maximal rate possible, the glucose concentration has a significant influence on the *E. coli* multiplication. This phase stops after 10-12 hours for the lowest concentrations of glucose (0.02% and 0.05%) and continues for up to 16-17 hours for the highest concentrations. The stationary phase was attained for lower concentrations of glucose much earlier than for 0.5 and 1% glucose concentration. This can be explained by the nutrient limitation; if an essential nutrient is severely depleted, population growth is slowed.

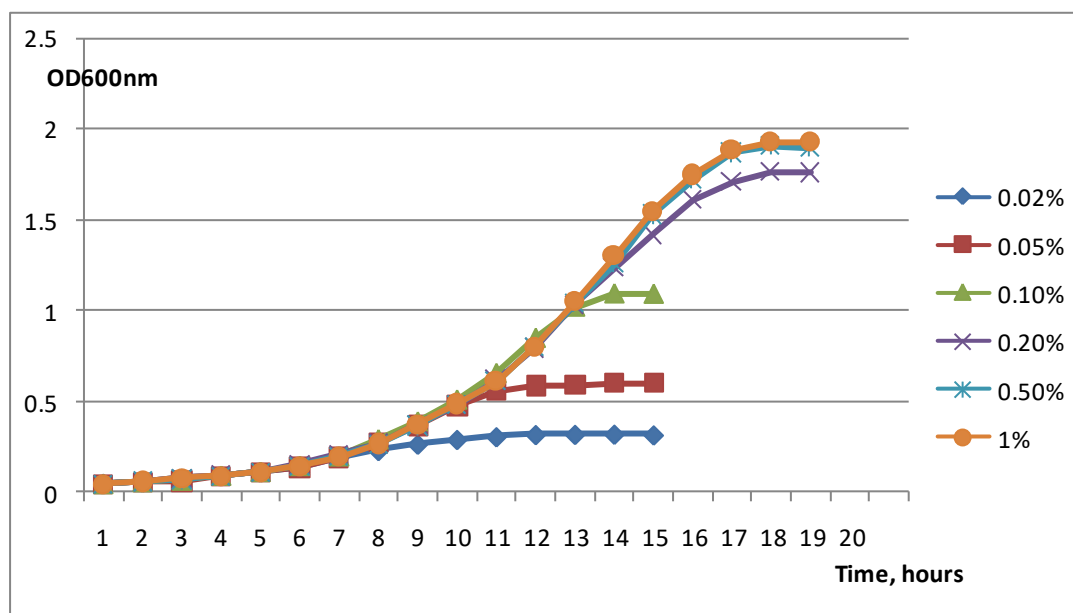

Figure 1: *E. coli* growth curves in media with 0.02%; 0.05%; 0.1%; 0.2%; 0.5% and 1% glucose concentration

The substrate consumption was analyzed through the determination of glucose concentration in culture at different time intervals. With the Glucose Colorimetric Assay Kit, QuantiChrom, a calibration curve was plotted and used for the analysis of substrate consumption, as see in figure 2.

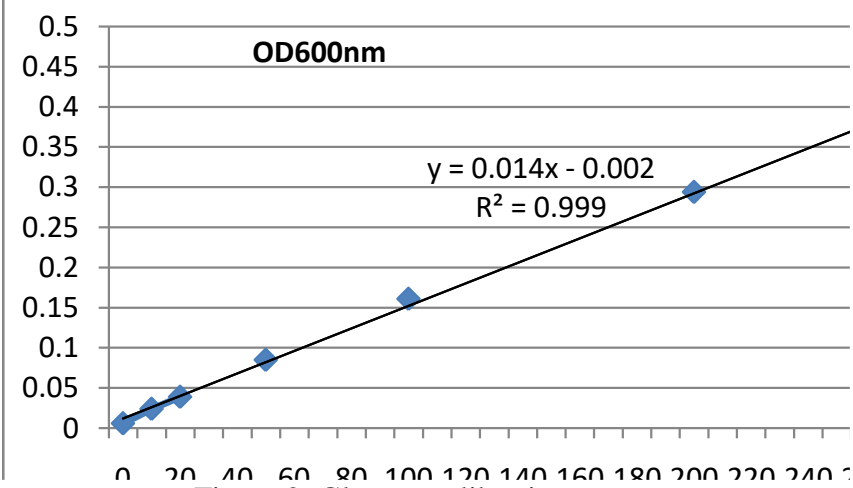

Figure 2: Glucose calibration curve

Figure 3 shows the curves for glucose consumption for initial concentrations of 0.05% and 0.1%. In both cases is noticed a slow decrease in glucose concentration for the first 4-5 hours, corresponding to the lag phase of growth. In the next 10 hours, the glucose consumption is high, and after 14 hours the concentration of this nutrient decreases to 1.5% after 11 hours for the initial concentration of 0.05%, and to 6% after 14 hours for 0.1% initial concentration of glucose.

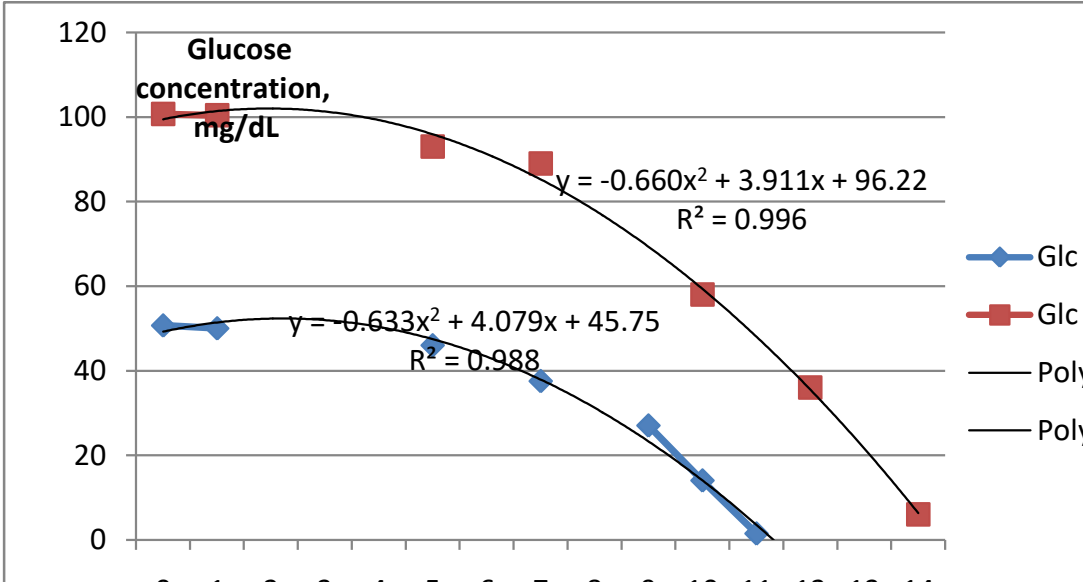

Figure 3: Substrate consumption curves for media containing 0.05% and 0.1% glucose concentration

The correlation between maximal OD values after 18 hours and the initial glucose concentration is shown in figure 4, where the curve is a logarithmic one.

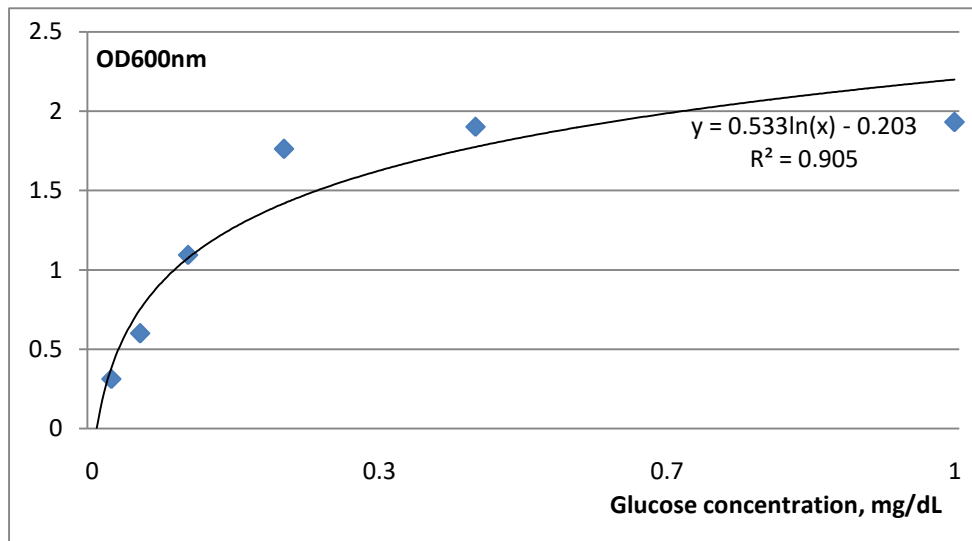

Figure 4: Dependence of maximal OD values on glucose concentration

Because glucose is the most important nutrient in this culture medium, the bacterial metabolism depends dramatically on the concentration of this sugar. Small differences in glucose concentration caused major changes in the growth and multiplication of *E. coli* K12-MG1655 in minimal medium, especially in the range in concentrations of 0.02-0.1%. For higher concentrations of glucose, the differences were smaller, because this limiting nutrient was sufficient for the members of bacterial population.

### 3. CONCLUSIONS

Microbiological quality is among key attributes to indicate integrity of food products and hygiene of food processing. *Escherichia coli*, which is ubiquitous in the environment, is considered a global indicator of fecal pollution and can cause severe diseases.

The growth of *E. coli* on minimal medium depends on the concentration of carbon source. The exponential phase stops after 10-12 hours for the lowest concentrations of glucose (0.02% and 0.05%) and continues for up to 16-17 hours for the highest concentrations. The stationary phase was attained for lower concentrations of glucose much earlier than for 0.5 and 1% glucose concentration. If an essential nutrient is severely depleted, population growth is slowed, due to the limitation of this major nutrient.

The substrate consumption is insignificant in the first 4-5 hours, corresponding to the lag phase, but has a high rate for the next 10 hours, in exponential phase of growth.

Small differences in glucose concentration caused major changes in the growth and multiplication of *E. coli* K12-MG1655 in minimal medium, especially in the range in concentrations of 0.02-0.1%.

### References

- [1] Begani, R., K., Tombe, B., Polong, T., "Effectiveness of cleaning and sanitation of food contact surfaces in the PNG fish canning industry", Contemporary PNG Studies: DWU Research Journal Volume 16, May 2012
- [2] Sangadkit, W., Rattanabumrung, O., Supanivatin, P., Thipayarat, A., "Practical coliforms and *Escherichia coli* detection and enumeration for industrial food samples using low-cost digital microscopy", Procedia Engineering 32, 126 – 133, 2012
- [3] Shahreza, M. H. S., Rahimi, E., Momtaz H., *Shiga-toxigenic Escherichia coli* in ready-to-eat food stuffs: Prevalence and distribution of putative virulence factors Microbiology Research, vol. 8, 88-93, 2017



- [4] Robinson, A., McKillip, J., *Biology of Escherichia coli O157:H7 in human health and food safety with emphasis on sublethal injury and detection*, Formatex Publisher, 2010
- [5] McClure PJ<sup>1</sup>, Hall S *Survival of Escherichia coli in foods Symp Ser Soc Appl Microbiol.*, 29, 61-70, 2000
- [6] Olsvik, O., Waterson, Y., Lund A., Homes E., *Pathogenic Escherichia coli found in food*, International Journal of Food Microbiology, Vol. 12, Issue 1, 103-113, January 1991
- [7] Branco, P., M., P., Fernandes, A., Cangani M., T., de Souza-Polo, A., de Lucas, J., do Amaral, L., A., *Effects of sugarcane juice addition on the population dynamics of Escherichia coli and the presence of Shiga-toxigenic E. coli during the anaerobic codigestion of dairy cattle manure*, <http://dx.doi.org/10.1590/0103-8478cr20170382>
- [8] Belluco, S., Barco, L., Roccato, A., Ricci, A., *Escherichia coli and Enterobacteriaceae counts on poultry carcasses along the slaughterline: A systematic review and meta-analysis*, Food Control, 60, 269-280, 2016
- [9] umaran, S., Deivasigamani, B., Alagappan, K., Sakthivel, M., Karthikeyan, R., *Antibiotic resistant Esherichia coli strains from seafood and its susceptibility to seaweed extracts*, Asian Pacific Journal of Tropical Medicine, 977-981, 2010
- [10] Amrita, V., Sonal D., Shalini R., *Antibacterial Effect of Herbs and Spices Extract on Escherichia coli* Electronic Journal of Biology, Vol. 5(2), 40-44, 2009
- [11] Saxena, T., Kaushik, P., Mohan, M., K., *Prevalence of E. coli O157:H7 in water sources: an overview on associated diseases, outbreaks and detection methods*, Diagnostic Microbiology and Infectious Disease, 82, 249–264, 2015
- [12] Saeedi, P., Yazdanparast, M., Behzadi E., Salmanian, A., H., Mousavi, S., L., Nazarian, S., Amani, J., *A review on strategies for decreasing E. coli O157:H7 risk in animals*, Microbial Pathogenesis, 103,186-195, 2017
- [13] Gomesa, T., Elias, W., Scaletskya, I., Gutha, B., Rodriguess, J., Piazzab, R., Ferreirac, L., Martinez, M., *Diarrheagenic Escherichia coli*, Brazilian journal of microbiology, 47, 3–30, 2016
- [14] Ray, B., Bhunia A, *Fundamental Food Microbiology*, Fourth Edition, CRC Press, USA, 2008
- [15] Baker, C., Rubinelli, P., Park, H., Carbonero, F., Ricke S., *Shiga toxin-producing Escherichia coli in food: Incidence, ecology, and detection strategies*, Food Control, 59, 407-419, 2016
- [16] Bandary, B., Hussain, Z., Kumar, R., *Effect of carbon and nitrogen sources on Escherichia coli bacteria in removing dyes*, Materials Today: Proceedings 3, 4023–4028, 2016
- [17] Veys, O., de Oliveira, S., Sampers, I., Tondo E., C., *Modelling the growth of Salmonella spp. and Escherichia coli O157 on lettuce*, Procedia Food Science, 7, 168 – 172, 2016
- [18] Jay, J., Loessner, M., Golden, D., *Modern Food Microbiology*, Seventh Edition, Springer Science, USA, 2005

# BENEFITS OF USING ADDITIVES IN THE PRODUCTION OF BIOMASS PELLETS

Găgeanu Iuliana<sup>1)</sup>, Voicu Gheorghe<sup>2)</sup>, Cujbescu Dan<sup>1)</sup>, Persu Cătălin<sup>1)</sup>, Gheorghe Gabriel<sup>1)</sup>,  
Voicea Iulian<sup>1)</sup>,

<sup>1)</sup>INMA Bucharest / Romania; <sup>2)</sup>University Politehnica of Bucharest / Romania

## ABSTRACT

The use of renewable energy has become a large concern in the last decades due to the rapid and inevitable depletion of fossil fuels combined with population growth that led to increased fuel consumptions. Out of the numerous forms of renewable energy, biomass is one of the easiest to use, due to its characteristics that are very similar to those of fossil fuels. One of the main problems in using biomass as a source of renewable energy is represented by that fact that it is hard to be used in its original state, therefore it has to be first treated and processed. Pelleting is one of the most common ways to process biomass and obtain solid biofuels. The paper presents a series of researches for determining the benefits of using additives for improving the quality of biomass pellets obtained for energetic purposes.

## 1. INTRODUCTION

The benefits of biofuels, compared to traditional fuels, are aimed at greater energy security, lower environmental impact, financial savings and socio-economic aspects related to the rural sector. The concept of sustainable development embodies the idea of inter-connectivity and balance between economic, social and environmental concerns. [1]

The composition of cellulosic biomass types: cellulosic biomass is composed of cellulose, hemicellulose, lignin and an extractive percentage, as shown in Figure 1 for a number of representative examples of agricultural residues, wood, municipal waste and herbaceous plants.

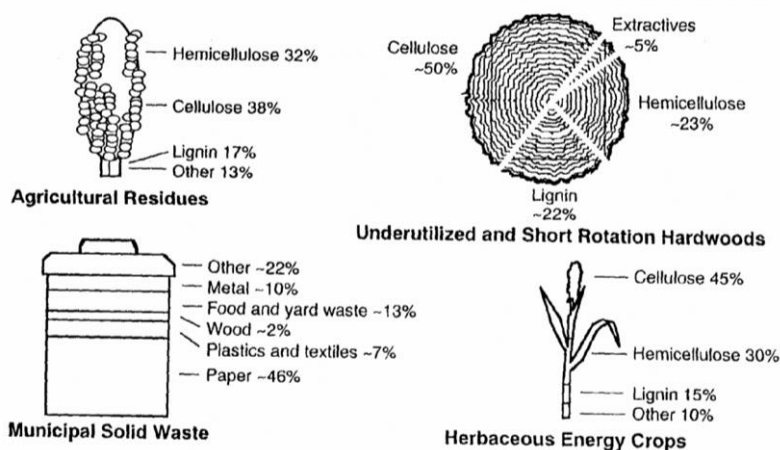

Figure 1: Composition of the most common types of biomass [2]

Usually, biomass is burned in its original state to generate heat and electricity, or it can be used as raw material for the production of biofuels (liquid biofuels such as biodiesel and bioethanol, or solid biofuels, such as pellets and briquettes) and some chemical compounds. Biomass is a biodegradable and renewable energy resource. Biomass production represents an expanding field due the increasing interest in alternative energy sources [3-6].

In table 1 are presented the main categories of plant biomass.

<sup>1</sup>6, Ion Ionescu de la Brad Blvd., tel.: +40762676642, e-mail: [iulia.gageanu@gmail.com](mailto:iulia.gageanu@gmail.com)

**Table 1****Main categories of plant biomass [3]**

<b>Biomass category</b>	<b>Content</b>
Biomass from primary agricultural crop	Total potential biomass from agricultural crops
Plant waste	Biomass from the secondary production and other plant waste
Biomass from fodder plants	Biomass from the production of fodder plants
Green fodder from natural pastures	Biomass from animal pasture
Wood	Wood harvested from wood-based products

Given the enormous demand for pellets, as well as the wide availability and diversity of biomass from the waste resulting from processing agricultural and forestry products, new types of pellets are currently entering the market. In particular, we highlight the pellets mixed with corn cobs, pellets obtained from the waste from the paper industry, as well as all types of cardboard, pellets obtained from hay, with many types of straws, with the remains of sunflower plant, corn, branches of any kind, waste from vineyards, ornamental shrubs, nut shells, hazelnuts, crushed almonds, cherry stalks, peaches, apricots, grape seed, etc[7-8].

Besides these, there are also leaves, grass, as well as all other plant waste from forest cleansing, as well as many other plant waste that can be used in the production of pellets. These new types of pellets are still in the experimental phase, and there are not yet well-defined regulations that demonstrate compliance based on standards. However, all alternative resources that can replace traditional fuels are welcome, while guaranteeing recycling of waste that remains unused [10].

If the raw material does not have sufficient pressing properties, additives from biological materials used in the mixture are needed. The paper presents a series of researches conducted for determining the benefits brought by using additives in the production of agricultural biomass pellets, namely on handling, transportation and storage and characteristics.

## **2. METHODOLOGY**

In order to determine the benefits of using additives in the biomass recipes pelleted on the final quality of the products, a series of tests were conducted on pellet samples. All pellets were produced using the same pelleting machine (a ring die pelleting machine with 9 mm orifices in the die) and the same particle sizes for all biomass materials, respectively <9 mm, obtained by grinding the biomass.

The determinations were conducted on pellets obtained only from one material (wheat straws and rapeseed stalks) as well as on two types of pellets obtained from mixes between these materials, in order to assess the differences between using only one material and using the same materials in combination. Pellets made from the combination between rapeseed stalks and straws had a 50% material from both biomass types. Pellets from wheat straws + corn starch had 95% straws and 5% starch.

Figure 2 shows the pellet samples used for tests.



Figure 2: Pellet samples used for determinations

The following storage and transportation quality parameters were determined for the final products: length, diameter, bulk and single pellet density, dust formation.

Pellet length and diameter was determined by measuring pellets using electronic callipers.

Dust formation during handling, transportation and storage was determined according to the method described in standard SR EN ISO 17831-1:2016 – Solid biofuels – Determination of mechanical durability of pellets and briquettes – Part 1: Pellets.

Bulk density  $BD_p$  ( $\text{kg m}^{-3}$ ) was determined using a cylinder with known volume, and a precision scale, according to the method described in standard SR EN ISO 17828:2016 – Solid biofuels – Determination of bulk density [9].

Single pellet density  $SD_p$  ( $\text{kg m}^{-3}$ ) was calculated using the pycnometer, by determining the volume displaced by introducing the pellet in distilled water and calculating the density using the formula:

$$SD_p = \frac{m_1}{(m_2 + m_1 - m_3) \times d_w} \quad (1)$$

where:

$m_1$  – mass of the pellet (kg);

$m_2$  – mass of pycnometer filled with distilled water (kg);

$m_3$  – mass of pycnometer plus distilled water with the pellet (kg);

$d_w$  – water density at working temperature ( $\text{kg m}^{-3}$ ).

The results from the determinations are shown in table 2. The data in table represents the average value from 3 determinations (for bulk density, single pellet density ad dust formation) or the average from 30 determinations (for length and diameter) conducted on the same type of pellet samples.

Table 2: Results from the tests conducted on agricultural biomass pellets

No.	Pellet sample	Length [mm]	Diameter [mm]	Bulk density [ $\text{kg/m}^3$ ]	Single pellet density [ $\text{kg/m}^3$ ]	Dust formation [%]
1.	Wheat straws 100%	15.83	9.46	544.53	970.12	8.22
2.	Rapeseed stalks100%	15.43	9.68	495.17	897.72	9.12
3.	Wheat straws 50% + rapeseed stalks 50%	16.27	9.22	558.66	1019.63	7.45
4.	Wheat straws 95% +corn starch 5%	30.21	9.01	637.78	1212.78	4.28

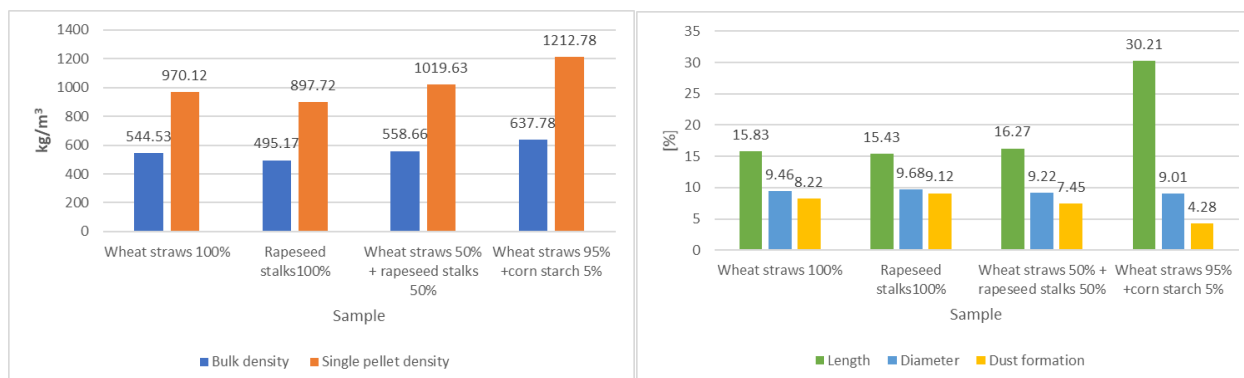

Figure 3: Comparison between the most important handling, transportation and storage characteristics

From table 2 and figure 3 it results that when combining the 2 types of materials and using corn starch in the recipe, we obtained good results in terms of length, diameter, bulk and single pellet density, as well as for dust formation, compared to the pellets obtained only from wheat straws or rapeseed stalks.

### 3. CONCLUSIONS

Based on the experimental data resulted, the following conclusions can be drawn:

1. The combinations between two types of materials tested showed that it is better to use materials such wheat straws or rapeseed in combination with other materials to obtain pellets with better quality;
2. The use of starch brought a significant improvement for all parameters measured, increasing pellet length, reducing pellet diameter (meaning that pellets expand less after exiting the pelleting die), increasing both bulk and single pellet density and reducing dust formation.
3. The use of material combinations as well as using a cheap and common additive can bring important benefits to the production, handling, transportation and storage of pellets, contributing to a sustainable development and use of energy, without affecting human and animal food necessities.

### Acknowledgement

This work was funded by the Executive Agency for Higher Education, Research, Development and Innovation Funding, within the project entitled "Optimizing the composition of biomass mixtures for obtaining high quality pellets", ctr. 24 BG / 2016 (code PN-III-P2-2.1-BG-2016-0266).

### References

- [1] Demirbas A. -Progress and recent trends in biodiesel fuels, *Energy Conversion and Management* 50, 2009, pp. 14–34;
- [2] Popa V. I. – Biomass as source of energy and chemical products, Technical University “Gheorghe Asachi” Iasi;
- [3] Material flows and economy development in Romania, National Statistics Institute, 2014, ISSN: 2067-2195;
- [4] Danciu A. et al. (2010). Technology for solid agricultural and forestry biomass capitalization for obtaining clean energy and reducing greenhouse effect gas emissions. Research Report, contract 21-008, INMA Bucharest;
- [5] Găgeanu I., Voicu Gh., Vlăduț V., Voicța I. (2017). Experimental research on the influence of recipes used on the quality of biomass pellets, *Proceedings of 16th International Scientific Conference Engineering for Rural Development – Jelgava*, pp. 785-791;
- [6] Berkesy L., Begea M., Berkesy C., Crăciun M., Suciu L. Qualitative aspects regarding biomass destined for heating, *Ecoterra*, no. 30, 2012, pp. 64;
- [7] Jezerska L., Zajonca O., Rozbroja J., Vyletěleka J., Zegzulka J. (2014). Research on Effect of Spruce Sawdust with Added Starch on Flowability and Pelletization of the Material, *IERI Procedia* 8, pp. 154–163;
- [8] Stelte W., Sanadi A.R., Shang L., Holm J.K., Ahrenfeldt J., Henriksen U.B. Recent developments in biomass pelletization – A review. *BioResources* 7(3), 2012, pp. 4451-4490;
- [9] SR EN ISO 17828:2016 - Solid biofuels - Determination of bulk density;
- [10] <http://www.tatanoassistenza.eu/RO/Utenti/FAQ/combustibili.htm>.

# CONSIDERATIONS ON IMPROVING BIOMASS PELLETS QUALITY BY USING ADDITIVES

Găgeanu Iuliana<sup>1)</sup>, Voicu Gheorghe<sup>2)</sup>, Cujbescu Dan<sup>1)</sup>, Persu Cătălin<sup>1)</sup>, Pandia Olimpia<sup>3)</sup>

<sup>1)</sup> INMA Bucharest / Romania; <sup>2)</sup> University Politehnica of Bucharest / Romania;

<sup>3)</sup> UASVMB – Faculty of Management, Economic Engineering and Rural Development / Romania

## ABSTRACT

Biomass represents the most important source of renewable energy that can lead to producing biofuels with very similar properties to fossil fuels. In order to obtain biofuels based on biomass materials, they first need to be processed and brought to the desired parameters depending on the biofuel that will be obtained. One of the most important biofuels obtained from biomass are pellets. Unfortunately, not all biomass (for example the most part of agricultural biomass) has adequate pelleting properties and therefore it was necessary to find ways to use these materials for obtaining good quality pellets. One way to ensure good quality pellets from agricultural biomass is to use additives in the pelleting recipe. The paper presents a research on the most important additives used that influence the final quality of pellets resulting from the pelleting process.

## 1. INTRODUCTION

Biomass represents the plant component of nature. As a form of keeping the Sun's energy in chemical form, biomass is one of the most popular and universal resources on earth. It provides not only food, but also energy, building materials, paper, fabrics, medicines and chemicals. Biomass is used for energy purposes since fire was discovered by humans. Today, biomass fuel can be used for various purposes - from space heating to the production of electricity and fuel for cars and planes [1].

Biomass is the biodegradable fraction of products, waste and residues from agriculture, including vegetal and animal substances, forestry and related industries, and the biodegradable fraction of industrial and urban waste.

Biomass heating is the oldest and best-established form of energy supply in the world and is inherently linked to the development of the human race. However, it was largely redundant due to the high energy density of fossil fuels, and its application to modern energy systems, especially in industrialized countries, has so far declined. A renewed interest in biomass-based energy systems comes from a variety of reasons. They are dominated by the interest in reducing greenhouse gas emissions, the emergence of new efficient biomass conversion technologies, and rising fossil fuel prices [2].

An increase in the biomass share in the energy mix could bring the following benefits:

- the diversification of Europe's energy supply;
- significant reduction of greenhouse gas emissions;
- direct jobs for people;
- potential for lower oil prices as a result of lower demand.

This means that under the conditions of an adequate industrial processing, fresh biomass can be converted into products similar to natural gas or liquid or solid fuels. By applying various transformation processes such as burning, gasification or pyrolysis, biomass can be transformed into "bio-fuels" for transport, "bio-heat" or "bio-electricity" [3].

---

<sup>1)</sup>6, Ion Ionescu de la Brad Blvd., tel.: +40762676642, e-mail: [julia.gageanu@gmail.com](mailto:julia.gageanu@gmail.com)

Biomass combustion is not only the oldest form of combustion used, but it is also one of the most complex management systems since it involves the use of solid fuels in a multi-phase reaction system with extensive interactions between thermal fluxes and mass, processes that have been properly analysed just recently and used in simulations to design efficient combustion systems. The key to understanding solid fuel combustion processes is to recognize that only gaseous fuels burn and release heat, and liquids and solids do not burn, but actually consume heat in the drying and volatile processes needed to convert them into gaseous fuel (fig. 1) [4].

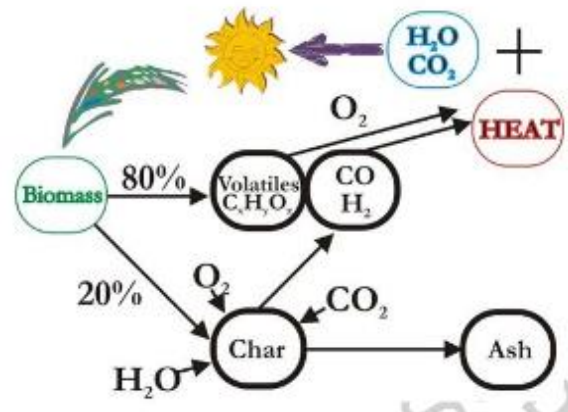

Fig. 1 – Diagram of biomass combustion and the closed carbon circuit [4]

One of the best methods to transform biomass into biofuels is represented by the pelleting process, which involves subjecting biomass to high pressures and forcing it through the cylindrical holes of a die. When exposed to appropriate conditions, biomass "merges" to form a solid mass. If the raw material does not have sufficient pressing properties, additives are needed to be used in the mixture.

The paper presents a research on the most important additives used that influence the final quality of pellets resulting from the pelleting process.

## 2. METHODOLOGY

Agricultural residues are an abundant and cheap source of energy from renewable sources. Agricultural residues are the most abundant (in terms of mass) biomass raw material in the world. About 1500 million tonnes of grain crops are produced annually worldwide. Due to the availability of this enormous amount of plant stalks and straws, it has recently been considered as a potential raw material for biofuel production. However, biomass from wheat straw and other crops has the disadvantage of having high porosity and low bulk density. Straw strain is of great importance for performing better handling, transport and storage operations [1].

Densification can increase the volumetric calorific value and the uniformity of physical properties leading to the production of denser, uniform, cleaner, and more energy-stable pellets as an ecological fuel.

In the production of pellets, various by-product materials can be used as additives or binding agents to improve their quality. The quality of the pellets (fig. 2) is determined by several key parameters such as moisture content, calorific value, fine particle size, mechanical durability, density, ash content and ash melting point. The values of these parameters are specified in regulations and standards. They define fuel classes, testing and sampling conditions, quality assurance methods and systems for supply and sales chains [5].



Figure 2: Pellets quality good (left); average (center); weak (right) [5]

The production of agricultural biomass pellets and the increase of their quality with additives is a more economical and ecological transition to energy generation from biomass residues. This approach uses existing power plant equipment without major changes, making the transition process more economical. [6]

A series of researchers have looked into the process of obtaining agricultural biomass pellets using additives for improving the pelleting process (lower energy consumption, lower pelleting time, etc.) as well as the final quality of products obtained (improved length, diameter, surface properties, higher calorific value, etc.).

Table 1 presents the most common used additives used for obtaining agricultural biomass with improved quality.

Table 1: Common additives used in pelleting recipes

Nr. crt.	Additives and binders	Percentage usually added to the total mass
1	Lignosulfonate	0 - 5%
2	Bentonite	0 - 5%
3	Glycerol	0 - 5%
4	Corn starch	0 - 5%
5	Potato starch	0 - 5%
	Paraffin	0 - 5%
	Palmityl	0 - 5%
	Dolomite	0 - 5%
	Untreated wood residues	0 - 30%
	Microwave pre-treated waste wood	0 - 30%
	Waste wood pre-treated in microwave with 5% glycerol	0 - 30%

Wood waste has a higher lignin content compared to agricultural straws and stalks and could be used as a good natural binder. Wood pellets such as wood sawdust or sawdust have been popular in European countries in the last decade. Wood pellets have good structural strength and lower dust and ash content. The recycling of wood waste is environmentally friendly and can also solve the problem of disposal. Generally, softwood has a higher lignin content than hardwood [7].

Chemical agents such as NaOH and calcium oxide have been added to wheat straw to reduce the fiber resilience properties to soften and enhance the interlocking ability of the particles to increase the durability of pellets. The key role of the NaOH pre-treatment solution is to interrupt the ester linkages between lignin and carbohydrates resulting in lignin solubility. The chemical and microwave pre-treatment was significantly proven to be able to disintegrate the



lignocellulosic structure of the wheat and barley strains and to increase the heating value, density and resistance of the pellets produced from these materials [2].

Grape pomace and tomato waste could be a valuable raw material for the production of biofuels. Mixing these residues with agricultural biomass can be a promising result for energy recovery. In fact, the mixture with ground biomass reduces the ash content, while densification leads to increased energy density. However, gas emissions are higher and are heavily affected by boiler operation parameters. Therefore, these parameters, such as the mass flow of water in the heat exchanger, the mass flow of the fuel, the primary and secondary air flow rates, must be adapted to each agri-food residue in order to benefit from this energy from renewable sources, without leading to a negative impact on the environment [8].

### 3. CONCLUSIONS

The physical and thermal parameters of the pellets are influenced by the use of different binders or additives added to the manufacturing process. According to EU standards, additives that improve fuel quality, reduce gas emissions or stimulate combustion efficiency can be added up to a maximum of 5% of the total mass of wood pellets. Also, considering the profitability of the production process and safety at work, it is very practical to use additives agents.

In the process of obtaining pellets, additives act as a lubricant, increase production and lower energy consumption per unit of product. Starch additives reduce the final moisture content of the pellets to a much greater extent than the lignosulphonate additives. In any case, too much starch will make the final product extremely dry, which affects the mechanical strength of wood pellets. Lignosulphonate addition results in improved mechanical durability. Starch and dolomite are the most efficient in reducing pellets density. Bentonite, paraffin, palmityl reduce dust formation during pelleting.

All these additives bring certain benefits to the pelleting process and further researches should be conducted to assess their influence, both beneficial and harmful on the process and on the final product.

### Acknowledgement

This work was funded by the Executive Agency for Higher Education, Research, Development and Innovation Funding, within the project entitled "Optimizing the composition of biomass mixtures for obtaining high quality pellets", ctr. 24 BG / 2016 (code PN-III-P2-2.1-BG-2016-0266).

### References

- [1] Gaber M., Handlos M., Metschina Ch. – Biomass manual. Quality assurance systems and quality control measures;
- [2] Tabil L., Adapa P., Kashaninejad M., - In biomass feedstock pre-processing: densification, Biofuel's Engineering Process Technology, M. A. Dos Santos Bernardes, Ed., pp. 439–464, InTech, New York, NY, USA, 2011;
- [3] Jezerska L., Zajonca O., Rozbroja J., Vyletěleka J., Zegzulka J., - Research on Effect of Spruce Sawdust with Added Starch on Flowability and Pelletization of the Material, IERI Procedia 8, pp. 154 – 163, 2014;
- [4] Overend R. – Direct combustion of biomass, renewable energy sources charged with energy from the sun and originated from earth-moon interaction, Vol. 1;
- [5] Kofman P.D. - The production of wood pellets, Processing / Products No. 10, Coford Connect, Dublin, Ireland, 2010;
- [6] Satyanarayana Narra, Yonggui Tao, Claudia Glaser, Hans-Jörg Gusovius, Peter Ay - Increasing the Calorific Value of Rye Straw Pellets with Biogenous and Fossil Fuel Additives, Energy Fuels 2010, 24, 5228–5234 : DOI:10.1021/ef100823b, Published on Web 08/31/2010;
- [7] European Pellet Council, Handbook for the Certification of Wood Pellets for Heating Purposes, European Pellet Council, Brussels, Belgium, 2011;
- [8] Nesrine Kraiem, Marzouk Lajili, Lionel Limousy, Rachid Said, Mejdí Jeguirim, „Energy recovery from Tunisian agri-food wastes: Evaluation of combustion performance and emissions characteristics of green pellets prepared from tomato residues and grape marc”, Energy 107 (2016) 409-418.

# **STUDY ON THE AUTOMATIC ADJUSTMENT OF THE CONSTRUCTIVE AND FUNCTIONAL PARAMETERS OF THE VIBRATORY TILLAGE TOOLS**

N.E. Gheorghită<sup>1</sup>, S.Șt. Biriș, N. Ungureanu, M.Ionescu, M.G. Munteanu  
University POLITEHNICA of Bucharest, Faculty of Biotechnical Systems Engineering

## **ABSTRACT**

Increasing the tillage process efficiency is a very important aspect to be considered in agricultural research. The use of self-vibrating active tools in the tillage process is attempted, primarily because the agricultural soil is not homogeneous. The paper presents a technical solution that will allow the automatic adjustment of the constructive and functional parameters of the active vibratory tillage tools to the soil resonance frequency.

## **1. INTRODUCTION**

Mechanical soil processing is a process involving high energy consumption. The purpose of soil processing is to create favorable conditions and an environment conducive to the growth of crop plants by altering the apparent density, granulometric composition of aggregates and other attributes[4]

The energy required for soil tillage is largely influenced by the physical properties of the soil, the exploitation characteristics of the agricultural aggregates and the geometric parameters of the working tools. Reducing energy consumption in soil cultivation is of particular importance given the significant share of energy consumption in harvesting. Due to the high energy consumption involved in soil treatment, even a small economy is significant.[2]

Soil processing organs usually carry out multiple processes simultaneously: displacement, stretching, compression, bending, twisting. Soil tools have the role of transferring a quantity of soil energy, following some desired effects such as cutting, shredding, overturning and soil displacement. Taking into account the reduction of energy consumption in soil processing, the design of optimal tools from the qualitative and economical point of view of the paper is being pursued. [3]

## **2. METHODOLOGY**

By inclination is meant, the relative angular tilt to the horizon or perpendicular. Any deviation from this home position (perpendicular) can be detected quickly and precisely with inclinometers. Inclinometers make use of the local gravity i.e. acceleration of gravity for the measurement of angular tilt. The MEMS technology (Micro-Electro-Mechanical-Systems) on which the inclinometer is based, enables multiple application solutions for machines, roboters, vehicles and airplanes, agricultural and construction machinery. [8]

The core piece of the inclinometer is a micromechanical capacitive sensor element. A capacitive accelerometer basically consists of two parallelly arranged “plate” electrodes with a dielectric placed in the middle. If the sensor is accelerated, the dielectric moves and thus the capacity relation between both electrodes is changed.[8]

---

<sup>1</sup> Splaiul Independenței nr 313, București, 0726453269, evelin\_gheorghita@yahoo.com



Fig.1 Dual Axis with CANopen Interface Inclinometer [8]

The difference between the vibration frequency and the natural frequency in Hz for the movements along Y direction and Z direction  $\Delta f_{Y,Z}$  can be calculated with :

$$\Delta f_{Y,Z} = E_{gY,Z} - E_{rY,Z} \quad (1)$$

where:  $E_g$  is the frequency in Hz when the vibration of the tine along corresponding axis in the soil has the highest energy; and  $E_r$  is the measure of the natural frequency defined when the movement has the highest energy during the run-up stage (reference data) in Hz.[5]

In the equation of motion of the tine, valid for both movements in X and Z direction is:

$$F = I\ddot{\theta} + c\dot{\theta} + k\theta \quad (2)$$

where: F is the torque exposed to the tine top in Nm; I the inertia of the tine in  $\text{Nms}^2$ ; c the damping factor in Nms; k the spring constant in N m;  $\theta$  the angle over which the tine moves in rad, and  $\dot{\theta}$  and  $\ddot{\theta}$  are its first and second time derivative of  $\theta$ . [5]

The most important parameters that affect the draught force and performance of the tool are forward speed, oscillating frequency and amplitude. And so, accurate prediction of the draught force as a function of these parameters is of great importance to the implement designer[6].

Research suggested that although the effective parameters on an oscillating tool are such in large quantities that only qualitative knowledge can be gained by investigation on the design parameters, however the natural frequency of the tool-vibrator system have quite a dominant role on optimizing the energy reduction [7]

Another past research such as Buston and MacIntyre (1981) reported that with a velocity ratio less than one tine oscillation had no effect on draft. However, this series of tests showed that for a positive oscillation angle of  $27^\circ$  and velocity ratio  $\lambda = 0.95$  that there was a significant draft force decrease of 15% from 30.2 kN (rigid) to 25.8 kN (oscillatory) [1].

Table1. Synopsis of subsoiler tine motion parameters for different frequencies ( $a = 69$  mm,  $\beta = 27^\circ$ ,  $V_0 = 0.8$  m/s) [1]

Frequency, Hz	Draft, kN
Rigid	30.2
1.9	25.8
3.3	18.5
3.5	17.8
4.9	16.6

### 3. RESULTS AND DISCUSSION

The study highlighted that the most likely technical solution which have the possibility to automatically adjust pretensioning and to provide elastic constants adapted to the required values is the one with helical spring mounted on the tool support. The spring can be mounted horizontally or vertically.

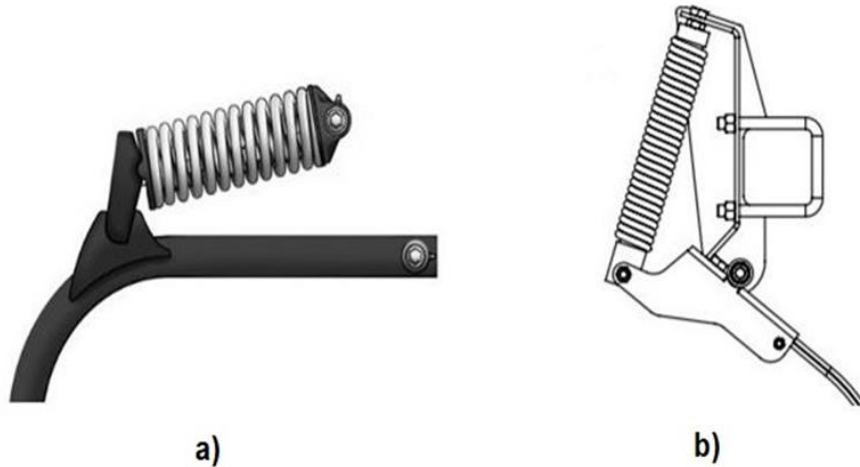

Fig.2 Types of helical springs: a-horizontal, b-vertical

Inclinometers attached to the superior part of the tines measure the angle and moments transferred from the tine to the framework.[8]



Fig.3 Vibratory working tool equipped with inclinometer

The draft force is well influenced by the constructive parameters of the vibratory tool, one of these being the settlement angle of the tool towards the direction of movement. Automatic spring pretensioning can best be done with an electrically controlled system.

#### 4. CONCLUSIONS

A vibratory tillage tool is an effective way of decreasing the draft force required to pull it through the soil. The draft force reduction is dependent on the combination of operating parameters and soil conditions. It is thus necessary to optimise the vibratory implement for different conditions.

The challenge of future research is to build a technical solution for the automatic adaptation of parameters so that the tool's effect on the soil to achieve maximum crumbling, which is produced for tool vibration frequencies close to the soils natural frequency.

The study highlighted that the most likely technical solution which have the possibility to automatically adjust pretensioning and to provide elastic constants adapted to the required values is the one with helical spring mounted on the tool support.

#### References

- [1]. Buston, M.J., MacIntyre, D., 1981. Vibratory soil cutting: 1-soil tank studies on draft and power requirements. *J. Agric. Eng. Res.* 26 (4), 409–418.
- [2]. Fechet T. L. V., Ros V., Coța C., Nagy M., *Optimizarea paramerilor geometrice ai unei scule active de lucrat solul*, Acta Technica Napocensis Series: Applied Mathematics And Mechanics, Vol. V, Nr. 50, p. 461-464, 2007
- [3]. Ghereș M.I., Cercetări privind optimizarea parametrilor geometrice și funcționali ai sculelor de lucrat solul în vederea reducerii consumului de energie, Teză de doctorat, Universitatea Tehnică din Cluj-Napoca, 2001
- [4]. Ivan I., Deac T., Analiza posibilităților de creștere a randamentelor agricole în România, Acta Technica Napocensis Series: Applied Mathematics And Mechanics, Vol. V, Nr. 50, p. 457-460, 2007
- [5]. Mouazen A.M., Duerinckx K., Ramon H., Anthonis J., Soil influences on the mechanical actions of a flexible spring tine during selective weed harrowing, *Biosystems Engineering*, Volume 96, Issue 1, p. 7-18, 2007
- [6]. Razzaghi, E., Sohrabi, Y., Vibratory soil cutting a new approach for the mathematical analysis, *Soil and Tillage Research*, 159, 33-40, 2016.
- [7]. Verma, B.P., Oscillating soil tools—a review. *Trans. ASAE* 14 (6), 1107–1121. Yow, J., Smith, J.L., 1976. Sinusoidal vibratory tillage. *J. Terramech.* 13 (4), 211–226, 1970
- [8]. Inclinator for slope angles, <http://www.turck.ro>

# CONSIDERATIONS ON SAGE CULTURE TECHNOLOGY AND ESSENTIAL OILS OBTAINING

Ion Grigore<sup>1)</sup>, Elena Sorica<sup>1)</sup>, Cristian Sorică<sup>1)</sup>, Andreea Iulia Grigore<sup>1)</sup>, Laurențiu Vladuțoiu<sup>1)</sup>

<sup>1)</sup>National Institute of Research - Development for Machines and Installations Designed to Agriculture and Food Industry - INMA, Bucharest, Romania, [ionica\\_grigore2001@yahoo.com](mailto:ionica_grigore2001@yahoo.com)

## ABSTRACT

This paper presents aspects on sage (*Salvia officinalis*) cultures technology, which includes all agrotechnical works necessary in the production process for the establishment, maintenance and harvesting of the crop, as well as the importance of cultivating this plant for the pharmaceutical industry, the cosmetic industry as well as the food industry. It also presents the main production elements of sage, some quality indices achieved in different ways of harvesting the stolons, as well as the production of plant mass and volatile oil from the cultivated sage.

**Key words:** sage, technology, essential oil, distillation, treatments

## 1. INTRODUCTION

*Salvia officinalis* (fig.1) is a member of Lamiaceae family and native to the Mediterranean region, also cultivated in our country in gardens, as decorative and medicinal species. Its popular name is garden sage. Its leaves are petiolated, ovate, fine whitish hairy, while the flowers are violet. [1] Sage name comes from the Latin word “salvare” (to heal).



Figure 1: *Salvia officinalis* [5]

It grows spontaneously on dry and stony land, on pastures and downhill. It grows in gardens, reaching a height of 30-70 cm; its violet flowers are arranged vertically, so in a circle, around a common axis; the leaves are opposite, white-woolly, shimmering silver and having a slightly bitter, aromatic fragrance. In winter, to save it from frost, the sage must be covered because it is sensitive to low temperatures. [2] Sage is a melliferous plant. The sage leaves contain an essential oil represented by terpenic substances, thujone, thuyol, sabinol. The leaves also contain tannins, bitter principles, vitamin B1, C, potassium salts, glycosides, polyphenols and resins [4].

Salvia has been known and used as a medicinal plant since antiquity by the Greeks and by the Romans. Thus, due to the complex action it exerted on the human body, it was given special therapeutic properties, being considered a universal panacea. Today it is used as infusion in the treatment of dental diseases and inflammations, in laryngitis and pharyngitis and as a remedy against angina, bronchitis, flu and pneumonia. It is also used in the treatment of chronic biliary disorders and dyspepsia. The leaf decoction is used as a disinfectant, anti-inflammatory and healing agent in stomatitis and upper respiratory tract infections. In traditional medicine, sage was used in the treatment of tuberculosis, digestive diseases, biliary lithiasis and as a remedy against hemorrhoids. Sage is widely used in the perfume and cosmetics industries. In some countries, it is used as a spice for dishes. [3] Sage leaf products are used to combat excessive sweating in various conditions. Sage products are also useful in abdominal meteorism conditions, biliary dyskinesia, as an adjuvant in treating diabetes mellitus, in some abdominal pain, inflammation of the mucous membranes (stomatitis, gingivitis, pharyngitis, tonsillitis) and skin or acne. [4]

Blooming takes place in May and lasts until September. The harvest is done at the beginning of the blooming (May-June) by cutting the green peaks, or gathering the leaves as many times as necessary between June and September, but in the first year the sage leaves are harvested only once. Drying of plant material will be done in the shade, sheds, bridges or by artificial drying at temperatures up to 35°C. The drying rate is 4:1.

Sage can be placed in semi-shady or bright areas, being a resistant, perennial plant. It is planted in spring, obtained from seeds or by dividing the root of a plant having grown more than one year. After seedling or sowing, the ground is watered. Later it is only sporadically watered, in the hot summers. Excess watering may cause leaves yellowing and falling.

## **2. MATERIAL AND METHOD**

The soil where sage is planted must be freshly loosened and manure or garden substrate fertilized, but not excessively, otherwise the plants leaves will grow more and they will bloom less. If the crop is to be established in the autumn, then before sowing, the soil will be very well ground and levelled with the disc harrow in the aggregate with an adjustable harrow and levelling bar. If sowing or planting is done in the spring, then the soil can be left in a raw furrow over the winter and will be prepared before establishing the crop, with a disc harrow and then with a combinator. [6]

Sage propagation can be done in two ways:

a) separating the root of a plant that has already grown for a year; it can be transplanted together with the soil on the root,

b) through seeds that are purchased from flower shops or stores having as a field of activity the sale of plant seeds, or from the seeds harvested from the flowers in the garden. The entire inflorescence is collected when the calyx (the tube at the bottom of the flower with three teeth at the top) has lost its blue or red colour, depending on the variety of sage.

It is planted or sown in autumn, and in the same year it will bloom. Once planted, the sage produces flowers annually and the diameter of the plant grows very little, 1-3 cm per year, without needing to cut the stems. [5] Sage culture requires longer distances between rows. The recommended distance is 60-70 cm between the rows, while the distance between plants per row is recommended to be 45-50 cm.

However, research shows that row spacing greatly influences the production of herb and essential oil. It was found that the optimal distance between the rows was 62.5 cm, the production a dry herb obtained being over 4 tonnes/ha and that of essential oil was over 75 litres/ha, respectively 6% and 19% more than in the case of sage sowed at a distance of 70 cm

between the rows. It is also recommended to sow at the surface when winter is about to come (1-2 cm) and deeper in the spring (3-4 cm). [3]

Maintenance works are carried out in the spring, when the rows are contoured, weeding is done on the row and the hoeing between the rows with a cultivator fitted with protective discs. When the plants form the third pair of leaves, their thinning must be made at a distance of 25 cm. In the first year of vegetation, the growth of the plants is slow, so it is necessary to control the weeds in time, performing weeding on the row and hoeing, 3 or 4 times, between the rows. In the following years, maintenance work is done as needed. Thus, in the second year of vegetation, the growth rate is intensifying and the plants form a large number of shoots. They lignify and must be removed from the culture during all vegetation years, because on these aged shoots the leaves formed have smaller dimensions, which leads to a lower amount of raw material and of lower quality. Therefore, starting with the second year of vegetation, in the spring, before the plants start vegetation, the lignified stems are removed from the culture by cutting them at a height of 8-10 cm.

Harvesting is carried out manually (or by cutting with special equipment for harvesting medicinal plants) and they are placed in baskets without being pressed. The seed harvesting is recommended to be carried out in the second year of vegetation. From the seed crop, the leaves are not harvested until the seed is harvested. Sage seeds ripe step by step and fall easily. Harvesting is recommended to start at the stage when the calyx of the flowers in the lower part of the inflorescence begins to dry.

For the production of essential oil, steam distillation is the most commonly used method.

The process consists in the passage of water vapours obtained in certain steam generators, in special boilers at temperatures above 100°C and various pressures in the vegetative mass (flowers, grass, etc.), placed on some sites or in special baskets.

### 3. RESULTS

The highest essential oil content was registered in the case of dried leaves, and the maximum yield of essential oil was obtained from the dried shoots.

Steam distillation is the most widespread method and is applied in most countries producing essential oils.

The components of the distillation plant are: the steam source, the boiler in which the raw material is placed, the cooling vessel and the Florentine vessel for the separation of essential oil and flower water.

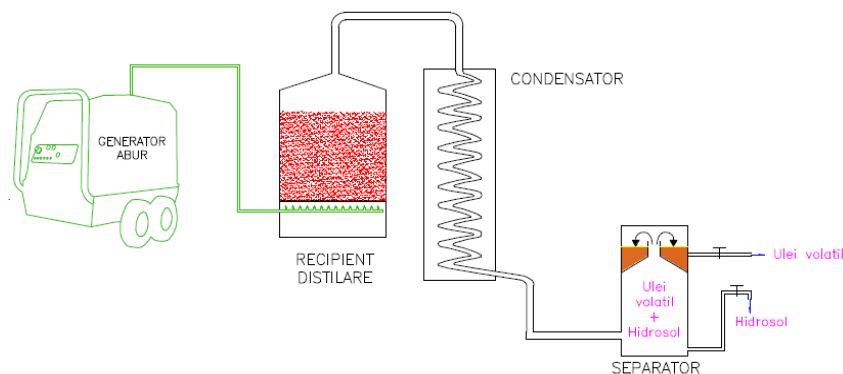

Figure 2: Technological scheme of the equipment for obtaining essential oils through steam distillation



The main technical characteristics of the installation for obtaining essential oils through distillation are presented in Table 1:

**Table 1**

No.	Characteristics	Values
1.	Vessel working capacity	approx. 700 l (90kg - 120kg)
2.	Working pressure	0.18 – 0.2 bar
3.	Working temperature	103 - 105°C

In order to conduct experimental research, freshly harvested plants of *Mentha piperita* variety were used and we obtained the following results presented in Table 2:

**Table 2**

Charge weight	Distillation time	Oil obtained (litres)	Flower water (litres)
90 kg	95 min.	1.65	28
100 kg	105 min	1.80	32
120 kg	125 min	2,12	35

The amount of sage that can be obtained from a well maintained culture is approx. 3500-4000 kg/ha green mass and after distillation by steam distillation method, 70-75 litres of essential oil can be obtained.

## CONCLUSIONS

Sage is one of the plants that should not be missing from the Romanians' home. Research over time has shown that this wonderful plant is also an excellent medicine with extraordinary therapeutic qualities for digestive system, nervous system, and many others. It is noted for many beneficial properties, but perhaps the most notable of them is the antiperspirant effect. Through an efficient processing, an amount of about 70-75 l of essential oil can be obtained of this plant, on a 1ha culture, which has a recognized therapeutic value being antifungal, antibacterial and antiviral, noted for the amelioration of various skin problems. It is also appreciated for the lipolytic and anti-cellulite effect.

## References

- [1] <http://www.horticultorul.ro/plante-medicinale/cultivarea-salviei-salvia-officinalis/>
- [2] <http://planteeco.blogspot.ro/2012/02/jalesul.html> /
- [3] <http://www.agrimedia.ro/articole/tehnologia-de-cultivare-pentru-jales-salvia-officinalis-salvie/-->
- [4] <http://www.csid.ro/plante-medicinale-fitoterapice-si-gemoterapice/salvia-salvia-officinale-11492253/>
- [5] <https://www.renovat.ro/cultivarea-salviei-in-gradina-p-1070/>
- [6] <http://www.informatii-agrorurale.ro/agropedia/cine-salvie-gradina-isi-salvata-viata/>

# DESIGN CONCEPTS OF MOBILE ROBOTS FOR AGRICULTURE

George IPATE<sup>1</sup>, Victor MOISE, Sorin-Ştefan BIRIŞ, Gheorghe VOICU,  
Filip ILIE, Gabriel Alexandru CONSTANTIN  
University POLITEHNICA of Bucharest

## ABSTRACT

This paper presents the basic mathematical models used in the development of an agricultural robot composed of chassis with contact sensors, two-engine drive group, manipulator arm for harvesting products and a working platform with webcam. A prototype machine that includes some of this configuration was built to carry out various agricultural works. The machine consists of a Cartesian manipulator mounted on a crawler mobile chassis. A camcorder is used to guide the travel direction, plant inspection, locating the products and straightening the robotic arm to them. The prehension device fix the product to be transported. Hardware architecture for real-time control consists of a development platform with microcontroller Atmega 328 of the family AVR and a large number of connectors for attaching other peripheral modules for detection, planning and control. The aim of this paper is to present the basic principles used in design, conceiving robots, as well as the calculations necessary to determine their position and orientation in the three-dimensional space, in relation to a reference axis system.

**Keywords:** agriculture robotic, robotic arm, camera sensor, mechatronics, Matlab

## 1. INTRODUCTION

In present, the science of robotics is experiencing a significant increase not only in university and scientific research institutions, but also in pre-school, primary and secondary education. We are at the beginning of the fourth industrial revolution, and the latest studies in the field show that, where it happened, robotization will stimulate the emergence of new jobs, and at the same time, will support raising the employee's standard of living.

According to statistical data, the average robotic level in Eastern Europe is 60 units per 10 thousand workers, much over our country, where we have a fairly low density, of only 15 robots to 10 thousand employees. Although it has made major progress, Romania is still quite far away of a robotization in the true sense of the word.

Robotic farming is a combination of advanced technologies for detection, mobility, navigation, computation and interaction implemented in order to carry out various types of agricultural works, [1]. Use of robotics in the agricultural sector has significantly improved overall production and product quality, be it cereals, legume, fruits and other agricultural products. Soil monitoring, proper irrigation, precise sowing or harvesting of the cultivated field are some of the main areas where agricultural robots work, [2,3].

In this context, the wider concern of researchers in the field is justified, for the continuous improvement of robots with applications in agriculture [4]. Research in the field of agricultural machinery development, with autonomous navigation must meet two major requirements: to achieve both a physical structure to operate in the agricultural environment, as well as a capable electronic architecture to integrate different and new electronic devices. The purpose of this paper is to study the development of a mobile robot equipped with a video camera and a

---

<sup>1</sup>Corresponding author email : [puiu.ipate@gmail.com](mailto:puiu.ipate@gmail.com)

manipulating arm who can perform various agricultural works such as cultivation and harvesting of vegetables, fruits and more or monitoring pedoclimatic factors.

## 2. MATHEMATICAL MODELLING OF MECHATRONIC SYSTEMS

Mathematical modelling is in essence the implementation of mathematics in real mechatronic system in obtaining, analysing and validating data which are necessary for a better knowledge and the achievement of reliable mechatronic systems [5].

### 2.1 Kinematic modelling of manipulator robots

Kinematic modelling of manipulator robots with flat robots is useful, much simpler and raises few problems from a mathematical point of view, [6]. Elements lengths,  $I_1$ ,  $I_2$  are constant and define the robot geometry, while the angles  $\theta_1$ ,  $\theta_2$  are variable and determine the relative positions of kinematic elements. In figure 1 the kinematic scheme is presented, the versorial scheme and the multipolar scheme of a two-degree mobility handler (manipulator with basic structure RR).

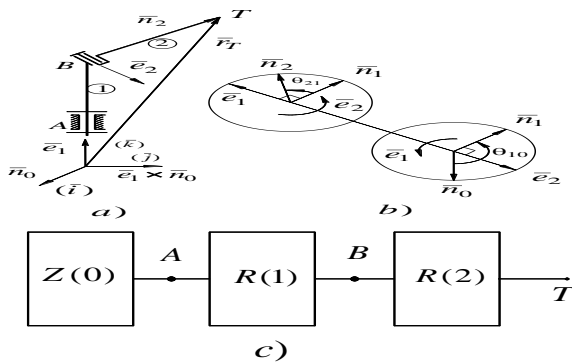

Fig. 1. Manipulator with two degrees of mobility

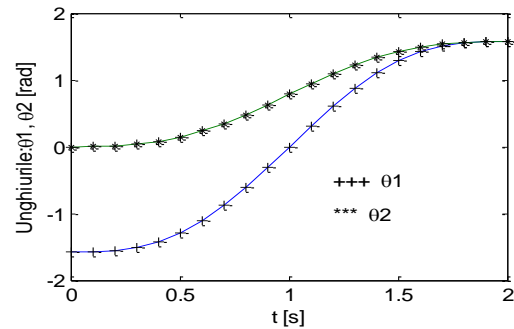

Fig. 2. Solution of matrix equation for angles  $\theta_1$  and  $\theta_2$

For kinematic analysis of the manipulator from figure 1 the matrix-vector method is used [7]. They are known:  $\theta_{10}$ ,  $\theta_{21}$ ,  $\omega_{10}$ ,  $\omega_{21}$ ,  $\varepsilon_{10}$ ,  $\varepsilon_{21}$  - generalized coordinates in active couples A, B;  $\theta_{10}^0 = -\pi/2$  [rad];  $\theta_{21}^0 = 0$  [rad] - the initial position of the mechanism;  $\alpha_1 = \pi/2$  - the angle of crossing between versors  $\bar{e}_1$  and  $\bar{e}_2$ ;  $s_1 = OB = 0.045$  [m]- axial displacement on direction of  $\bar{e}_1$ ;  $a_1 = 0$  - distance between versors  $\bar{e}_1$  and  $\bar{e}_2$ ;  $a_2 = BT = 0.06$  [m] - distance from the point B to the tracer point T, measured in the direction of normal  $\bar{n}_2$ ; transmission functions in motor couples are combined functions (trigonometric with polynomial);  $t$  - the time period during which the movement takes place.

Vectorial equation of the tracer point T is given by the relationship:

$$\bar{r}_T = s_1 \bar{e}_1 + a_2 \bar{n}_2 \quad (1)$$

Making the projection of the vector equation on the axes of the coordinate system OXYZ, the position of the tracer point is shown:

$$\begin{cases} X_T = a_2 D_2; \\ Y_T = a_2 E_2; \\ Z_T = s_1 + a_2 F_2, \end{cases} \quad (2)$$

where functions  $D_2$ ,  $E_2$  and  $F_2$  have, for the considered manipulator model, the following expressions:

$$D_2 = \cos\theta_{10} \cos\theta_{21}, E_2 = \sin\theta_{10} \cos\theta_{21}, F_2 = \sin\theta_{21} \quad (3)$$

For the matrix solving of the kinematics of the manipulator (determination of positions  $X_T, Y_T, Z_T$  of the tracer point  $T$ , the following relationship is written:

$$\begin{bmatrix} X_T & Y_T & Z_T \end{bmatrix}^T = P \cdot AS \quad (4)$$

$$\text{where: } P = \begin{bmatrix} D_1 & D_2 & 0 & A_2 & A_3 \\ E_1 & E_2 & 0 & B_2 & B_3 \\ 0 & F_2 & 1 & C_2 & C_3 \end{bmatrix} \quad (5)$$

$$AS^T = \begin{bmatrix} 0 & a_2 & s_1 & 0 & 0 \end{bmatrix} \quad (6)$$

Solution of matrix equation for angles  $\theta_1$  and  $\theta_2$  is presented in fig. 2. The results were obtained by running the simulation program made in the environment MATLAB knowing the law of motion.

## 2.2 Robots' manipulator type workspace

The workspace of a manipulator is the space which contains all the points that can be reached by the final end of the last kinematic element of positioning mechanism or a point of the orientation mechanism, but not the end effector [8].

Workspace depends on the number of degrees of freedom, by kinematic parameters, by the length of the arms, the mass of the manipulated object, etc. Total workspace is the volume that contains all the points that can be reached by the final effector, in at least one orientation thereof.

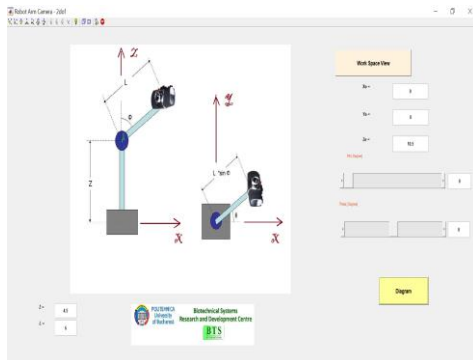

Fig. 3. Simulation program interface of the camcorder manipulation arm kinematics

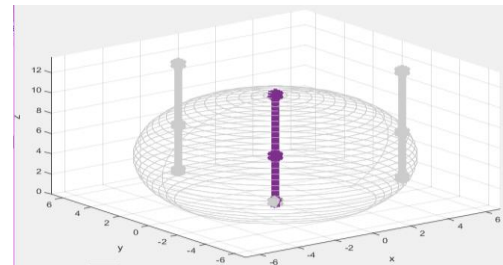

Fig. 4. Total workspace

Viewing camera attached to the end of the item can be considered as a final effector. Which is important as the load of the manipulator is the Cartesian position of the goal, along with the direction the camera is shooting; rotation around the camera axis does not matter. Thus, the camera configuration can be described by five coordinates:  $(x; y; z)$  for the Cartesian position of the camcorder and the spherical coordinates  $(\varphi; \theta)$  to describe the direction in which the camera is shooting. Using the simulation program made in Matlab shown in the figure 3, we can get the camcorder total work space, as can be seen in the figure 4. Volume and shape of the workspace are very important for the robot application, because they determine its possibilities.

## 2.3 Movement of rigid bodies

A rigid body is fully described in three-dimensional space by its position and orientation in relation to a reference system. Special Euclidian Group ( $SE_3$ ), also known as the group of

rigid body movements or the homogeneous transformation matrix in space  $R^3$ , is the set of all real matrices  $4 \times 4$   $T$  of form [9]:

$$T = \begin{bmatrix} R & p \\ 0 & 1 \end{bmatrix} = \begin{bmatrix} r_{11} & r_{12} & r_{13} & p_1 \\ r_{21} & r_{22} & r_{23} & p_2 \\ r_{31} & r_{32} & r_{33} & p_3 \\ 0 & 0 & 0 & 1 \end{bmatrix} \quad (7)$$

where  $R \in SO(3)$  represents the rotation matrix (orientation), and  $p \in R^3$  is the translation (position) column vector.

Homogeneous transformation matrix  $T$  is used in three major situations [9]: to represent the configuration (position and orientation) of a rigid body; changing the reference system in which a vector is represented or a coordinate system; to move a vector or a coordinate system.

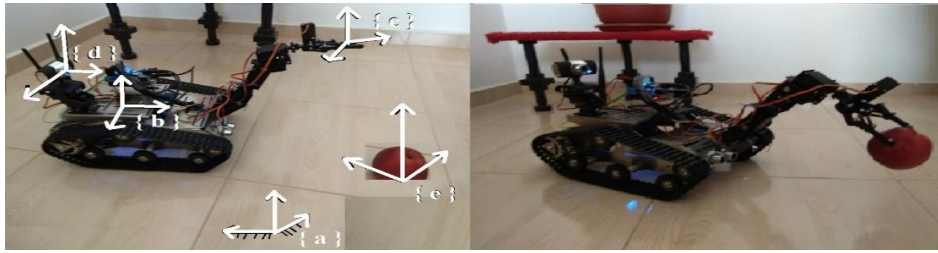

Fig. 5. Mobile platform with crawlers, manipulator robotic arm and camcorder

Figure 5 presents the prototype of the mobile platform with crawlers which moves into an enclosure, and on which a manipulative robotic arm was mounted and a camcorder fixed to another manipulator arm. Axle systems  $\{b\}$  and  $\{c\}$  are attached to the crawler mobile platform and the robotic manipulator arm effector, and the axle system  $\{d\}$  is attached to the inspection video camera. The fixed reference system  $\{a\}$  was established as the operator, and the robot has to lift an object that has the axle system  $\{e\}$ . In order to determine the position and orientation of the robot in the three-dimensional space we use the homogeneous transformation matrices to lift the object. Homogeneous transformation matrices  $T_{db}$  and  $T_{de}$  can be determined from the measurements performed with the camcorder. A geometric pattern for distance detection against an object using the monocular vision method was proposed by Ji and others, 2004 [10].

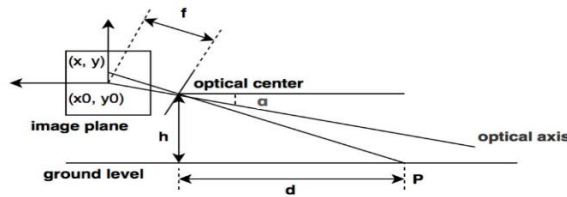

Fig. 7. The geometric pattern of distance detection from an object

$P$  is a point on the target object, and  $d$  the distance from the optic center to the point. Based on the geometric relationship of figure 7, distance  $d$  is calculated with relationships (8-10) as follows [10]:

$$d = h / (\delta + \arctan((y - y_0) / f)) \quad (8)$$

$$u = \frac{x}{dx} + u_0 \quad v = \frac{y}{dy} + v_0 \quad (9)$$

For  $x_0 = y_0 = 0$ , from (8) and (9) we obtain:

$$d = h / \tan(\alpha + \arctan(\frac{v-v_0}{a_y})), \quad a_y = f / dy \quad (10)$$

In relationships (8-10),  $f$  is the focal length of the camera;  $\delta$  is the angle of inclination of the camcorder;  $h$  is the height of the optical center. By applying the relationship (10), physical distance  $d$  is calculated in centimeters.

Homogeneous transformation matrices  $T_{bc}$  and  $T_{ad}$  can be calculated using measurements of the angles of hinge joints. Homogeneous transformation matrices when switching from one axle to the next, calculated and known are given as follows:

$$\begin{aligned} T_{de} &= [0 \ 0 \ -1 \ 300; 0 \ -1 \ 0 \ 100; -1 \ 0 \ 0 \ 120; 0 \ 0 \ 0 \ 1]; \\ T_{ad} &= [0 \ 0 \ -1 \ 400; 0 \ -1 \ 0 \ 50; -1 \ 0 \ 0 \ 300; 0 \ 0 \ 0 \ 1]; \\ T_{bc} &= [0 \ -0.7071 \ -0.7071 \ 30; 0 \ 0.7071 \ 0.7071 \ -40; 1 \ 0 \ 0 \ 25; 0 \ 0 \ 0 \ 1]; \\ T_{db} &= [0 \ 0 \ -1 \ 250; 0 \ -1 \ 0 \ -150; -1 \ 0 \ 0 \ 200; 0 \ 0 \ 0 \ 1]; \end{aligned} \quad (11)$$

To calculate the motion of the robotic arm to pick up the object, the configuration of the object to the arm, the homogeneous transformation matrix must be determined  $T_{ce}$ . It is known that  $T_{ab}T_{bc}T_{ce} = T_{ad}T_{de}$ , where the only quantity we do not know directly is the matrix  $T_{ab}$ .

However, since  $T_{ab} = T_{ad}T_{db}$ , in the end, we can write the transformation equation to calculate the required transformation matrix,  $T_{ce}$ , as follows:

$$T_{ce} = (T_{ad}T_{db}T_{bc})^{-1} T_{ad}T_{de} \quad (12)$$

From data transformation matrices we get:

$$\begin{aligned} T_{ad} T_{de} &= [1 \ 0 \ 0 \ 200; 0 \ 1 \ 0 \ 200; 0 \ 0 \ 1 \ 50; 0 \ 0 \ 0 \ 1]; \\ T_{ad} T_{db} T_{bc} &= [0 \ -0.7071 \ -0.7071 \ 230; 0 \ 0.7071 \ -0.7071 \ 160; 1 \ 0 \ 0 \ 75; 0 \ 0 \ 0 \ 1]; \\ (T_{ad} T_{db} T_{bc})^{-1} &= [0 \ 0 \ 1 \ -75; -0.7071 \ 0.7071 \ 0 \ 49.4975; -0.7071 \ -0.7071 \ 0 \ 275.77; 0 \ 0 \ 0 \ 1]; \end{aligned} \quad (13)$$

of which the transformation matrix  $T_{ce}$  is rated at:

$$T_{ce} = [0 \ 0 \ 1 \ -75; -0.7071 \ 0.7071 \ 0 \ -183.84; -0.7071 \ -0.7071 \ 0 \ 113.13; 0 \ 0 \ 0 \ 1] \quad (14)$$

The first three elements of the first three columns from the matrix  $T_{ce}$  define the orientation of the manipulated object in the three-dimensional space, and the first three elements of the fourth column represent the coordinates of the characteristic point of the manipulated object, in relation to the origin of the fixed reference system.

### 3. EXPERIMENTAL VALIDATION

One of the most important tasks of the mobile robot consists of the ability to collect data about the environment they are in. Figure 8 illustrates the environmental images collected through the robot's colour camcorder. Robot field testing has demonstrated that the robot can navigate autonomously along the rows of plants and ensuring the preservation of crop plants. The two independent drive motors have the ability to develop a traction force enough to ensure the robot's locomotion and the equipment installed on it and manoeuvre it very easily, as shown in Figure 9. To achieve good performance in a variety of field configurations and for various objects, it is necessary to use the most appropriate strategy.

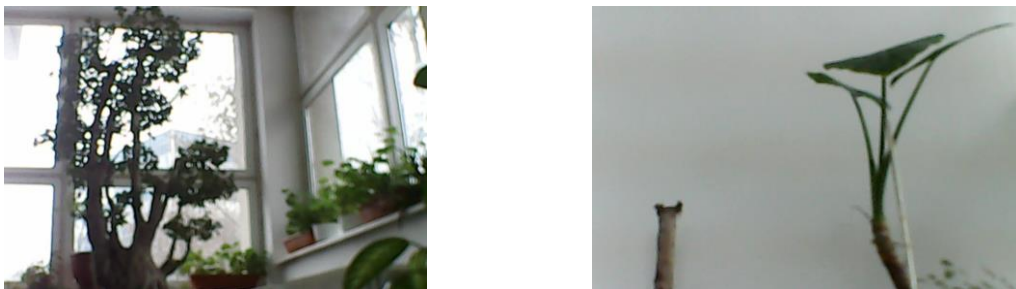

Fig. 8. Inspection of plants in an enclosure

Experiments demonstrate that different modes of exploitation of environmental constraints succeed in different conditions. So, the main objective is to maintain the arm's handling (and vehicle mobility when handling a mobile handler) to as high a level as possible, thus allowing the arm (and to vehicle when it is used) to respond effectively to unknown environmental conditions and simultaneously to different co-operation tasks [11]. It can be concluded that the trend of development for guidance systems for agricultural vehicles will be represented by digital technologies.



Fig. 9. Moving the robot to the work area

#### 4. CONCLUSIONS

This paper provides a brief review of research on the implementation of mathematical models in the design of a robot for agricultural operations. To simulate, plan and control robotic manipulation tasks using mathematical models, we need an understanding of (at least) three elements: the contact kinematic, forces applied by contacts and rigid body dynamics. By multiplying all transformation matrices is described complete transformation from the base frame to the final effector. Farm robots equipped with inspection camera can move and provide visual information to identify different plant diseases or microorganisms which can produce different processes, so can answer to specific tasks.

#### ACKNOWLEDGEMENT

The work has been funded by Ministry of National Education and Research through the Executive Agency for Higher Education, Research, Development and Innovation Funding, within the project entitled „ Base of agro-mechanical practical applications with intelligent monitoring systems in gardens, solariums and orchards (BAPRAGROSIM)”, CNFIS-FDI-2018-0086.

#### References

- [1] Blackmore, B. S., Stout, W., Wang, M., and Runov, B., *Robotic agriculture – the future of agricultural mechanisation?*, 5th European Conference on Precision Agriculture. ed. J. Stafford, V. The Netherlands, Wageningen Academic Publishers. pp.621-628, 2005.
- [2] Pedersen, S. M., Fountas, S. and Blackmore, S., *Agricultural Robots – Applications and Economic Perspectives*, Chapter from the book Service Robot Applications, InTechOpen, 2008.
- [3] Kushwaha, H. L., Sinha, J. P., Khura, T. K., Kushwaha, D. K., Ekka, U., Purushottam, M. and Singh, N., *Status and Scope of Robotics in Agriculture*, International Conference on Emerging Technologies in Agricultural and Food Engineering, 27 – 30th December, IIT Kharagpur, 2016.
- [4] Yaghoubi, S., Akbarzadeh, N.A., Bazargani, Sh.S., Bazargani, Sa.S., Bamizan, M., Asl, M.I., *Autonomous Robots for Agricultural Tasks and Farm Assignment and Future Trends in Agro Robots*, International Journal of Mechanical & Mechatronics Engineering IJMME-IJENS Vol.13 No:03, 2013.
- [5] Crnokić, B., Grubišić, M. and Volarić, T., *Different applications of mobile robots in education*, International Journal on Integrating Technology in Education (IJITE) Vol.6, No.3, 2017.
- [6] Moise, V., *Cinematica si controlul mecanismelor manipuloare cu 4 grade de mobilitate*, Teza de doctorat, Universitatea POLITEHNICA din București, 1986.
- [7] Moise, V., Simionescu, I., Ene, M., *Sinteza optimală a mecanismelor cu came*, Ed. Printech, București, 2011.
- [8] Doroftei, I.D., *Bazele roboticii*, Curs revizuit, Universitatea Tehnica “Gh. Asachi” Iași, 2016.
- [9] Lynch, K.M., Park, C.F., *Modern Robotics - Mechanics, planning, and control*, Cambridge U. Press, 2017. <http://modernrobotics.org>
- [10] Ji, C.J., Guo, L., Libibing, L., Rongben, W., et al, *Study on Method of Detecting Preceding Vehicle Based on Monocular Camera*, IEEE Intelligent Vehicles Symposium University of Parma Parma, Italy, pp. 751-755, 2004.
- [11] Beran, T.N., Ramirez-Serrano A., *Robot Arm-Child Interactions: A Novel Application Using Bio-Inspired Motion Control*, Chapter from the book Robot Arms, InTechOpen, 2011.

# STUDIES AND RESEARCH REGARDING THE TECHNOLOGY OF EXTRACTING VOLATILE OILS FROM MEDICINAL HERBS

Phd. Stud. Eng. Laza Evelin-Anda<sup>1</sup>, PhD. Eng. Caba Ioan Ladislau<sup>1</sup>  
PhD. Eng. Păun Anișoara<sup>2</sup>, Phd. Eng. Vlăduț Valentin

<sup>1</sup>INMA Bucharest – Sucursala Timisoara / Romania

<sup>2</sup>INMA Bucharest / Romania

Tel: 0256.499.336, e-mail: eveline\_anda@yahoo.com

## ABSTRACT

*At present, volatile oils have a wide range of applications, being used in cosmetics and medicine, especially in the treatment known as aromatherapy, nutrition, plant protection. These oils are called volatile because they usually evaporate at low temperatures, mostly at room temperature, and give a pleasant smell. In the literature, volatile oils are also referred to as essential oils or essential oils*

## 1. INTRODUCTION

Volatile oils have been used since ancient times, 6,000 years, for their special qualities, for perfume, for massage oil or for other therapeutic purposes. In ancient Greeks, essences and perfumes have played a big role in medicine, which have an antiseptic role. From the Greeks, the perfumes went to the Romans, and then their production and use expanded.[2]

These oils are called volatile because they usually evaporate at low temperatures, mostly at room temperature, and give a pleasant smell. In the literature, volatile oils are also referred to as essential oils or essential oils.[1,2]

At present, volatile oils have a wide range of applications, being used in cosmetics and medicine, especially in the treatment known as aromatherapy, nutrition, plant protection, etc. [1,2]

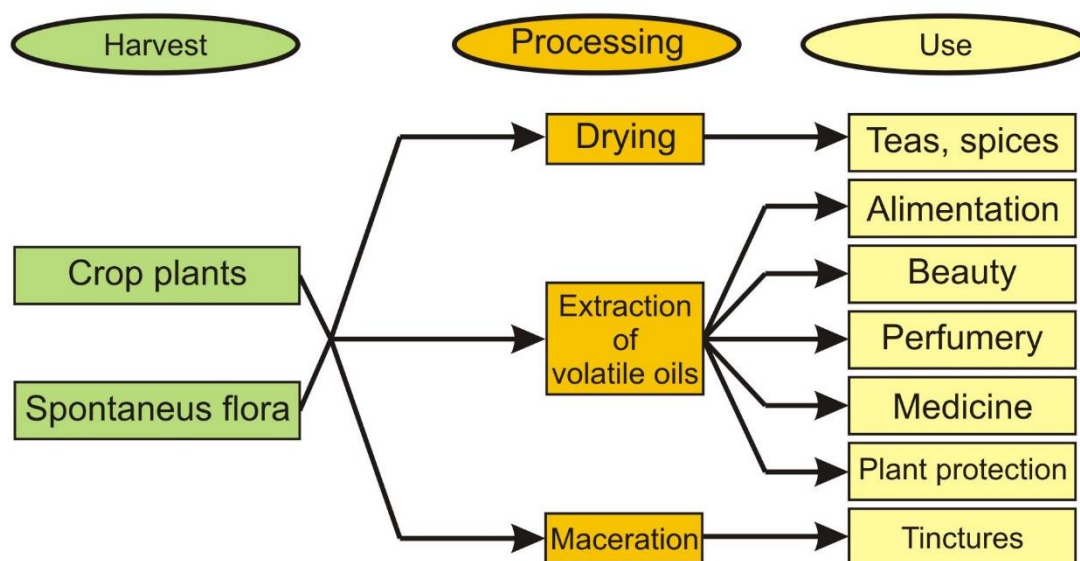

Figure 1: Areas of use of medicinal and aromatic plants



The quality of volatile oils depends on the extraction process used, which must be appropriate to the characteristics of the plant, but also to the quality of the plants from which they are extracted and to their processing before the introduction of the volatile oils into the extraction process.

In principle, distillation is a process of separating the components of a homogenous liquid mixture, based on the difference between the boiling temperatures of the constituents, the temperatures to which they correspond, and different vapor pressures.

At the boiling temperature of the mixture, the more volatile components (those having lower boiling temperatures) have higher vapor pressures and will find themselves in the vapor phase at higher concentrations than in the liquid phase from which they originated.

Condensation of the vapors thus obtained forms the distillate and the liquid formed by the volatile components is the residue [3,4,5] In the case of distillation of medicinal and aromatic plants, the vapor mixture consists of oil vapor and water vapor from the heating agent (steam) and the water contained in the plants [4,5,6] Distillation of aromatic plants for the production of volatile oils can be done by several methods: water, water and steam, and steam only. Other methods of extraction of volatile plant oils are cold extractive extraction, impregnation extraction, solvent extraction, hydrodynamic extraction, carbon dioxide extraction, turbodestillation extraction, microwave accelerated distillation [6,7,8]

## 2. METHODOLOGY

The conditions for separating the two components of a binary mixture depend on the relationship between the liquid phase and the vapor phase of a liquid-vapor-balanced system. [6].

For ideal blends, vapor pressure is a linear function of the molar composition, no volume variations occur during the process, the isobar equilibrium curves or isotherms have a unidirectional variation, and the vapor pressures and boiling temperatures vary over the entire concentration range mixture within the limits of the pure components. For these mixtures, the boiling temperature has a value between the boiling temperatures of each component [3, 6, 9]

Steam distillation is a method most commonly used for separating volatile oils from medicinal and aromatic plants and is based on the principle of heterogeneous azeotropy of reducing the distillation temperature, that is to say by lowering the boiling temperature by increasing partial pressures using water-saturated steam, usually saturated. [3, 6, 7, 9]

The composition of the water and oil vapor mixture is richer in the most volatile element, i.e., the etheric oil, than in the liquid phase from which it has formed under the action of heat.

Therefore, by condensing the vapor phase, a much more volatile liquid is obtained and less in the water than before. The higher the volatile oil concentration in the vegetal material, the greater is also the condensation vapor mixture [3,6,7,8,9]

The mechanism and laws expressing the process of water vapor entrainment are differentiated according to: the type of mixture (ideal or non-ideal); the manner in which the distillation operation is carried out (batch or continuous process); number of components in the mixture. [3, 6, 7, 8, 9]

The distillation process of volatile oils in plants has the following characteristics: it is batchwise (in batches); the resulting mixture is non-ideal (heteroazeotrope); the product to be trained is a mixture of volatile oils with close physical characteristics. [3, 6, 7, 8, 9]

For experimentation, an installation was used to extract volatile oils from medicinal and aromatic crops or spontaneous flora by the steam entrainment method.

The steam distillation plant of the medicinal and aromatic plants consists of the following main parts: Support frame (1), distillation vessel (2), condenser (3), separator (4), cooling water inlet assembly (5) a cooling water outlet (6), a lifting device (7), a water tank assembly (8), a steam generator (9)

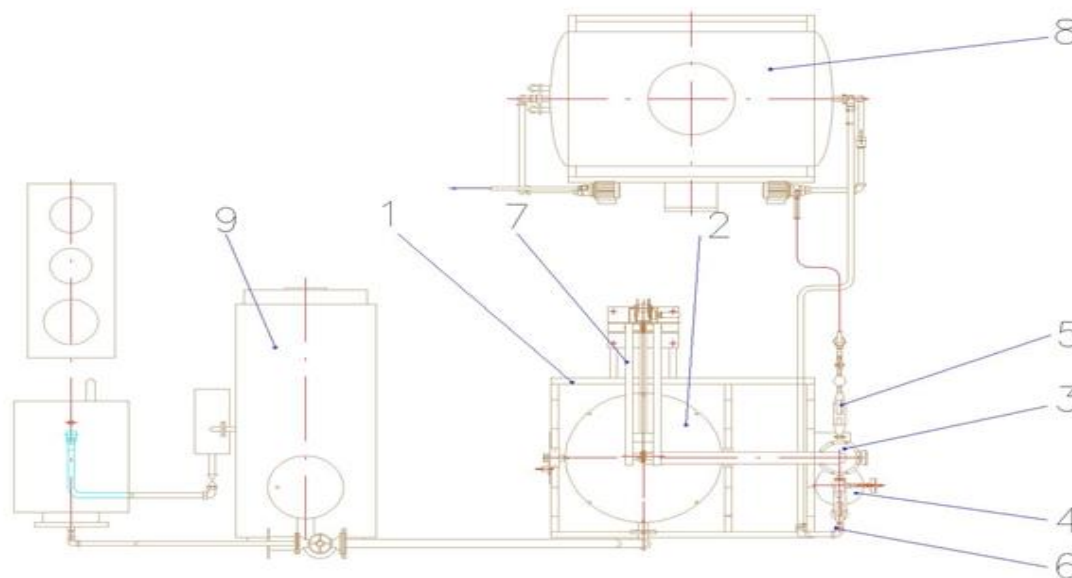







Figure 3: The composition of the steam distillation plant for the extraction of volatile oils

The operation of the installation for extracting volatile oils from medicinal and aromatic herbs by steam distillation is as follows: the steam required for distillation is provided by the steam generator which uses softened and preheated water and is introduced into the lower part of the distillation vessel in which the batch of plants was previously loaded and compacted by tipping the container into the loading position. The steam coming out through the orifices of the dispensing pipe in the container enters the compacted plant mass and drives the volatile oils comminuted therefrom so that at the upper part of the container a mixture of water vapor and volatile oils is formed which is led into the condenser through the conduit links the two subassemblies. Three types of plants were used for experimentation: lavender, mint and sage, delivered by the supplier in batches.

The characteristics and appearance of the plants are presented in the table below.

Table:1 Characteristics and appearance of Lavender, Sage and Mint

Name The part used	Appearance of the green plant	The aspect of the dried plant used
Name: <i>Lavender</i> <i>(Lavandula angustifolia)</i>  The part used: <i>flowers, stem</i>		

<p>Name: <i>Sage</i> (<i>Salvia officinalis</i>) The part used: <i>leaves, flowers, stem</i></p>		
<p>Name: <i>Mint</i> (<i>Mentha piperita</i>) The part used: <i>leaves, flowers, stem</i></p>		

Since the experimental period did not correspond to the plant harvest period, these were done only with dried plants. It is right that by drying the medicinal and aromatic plants lose a small part of the volatile oil content, instead the efficiency of the crate distillation process due to the larger quantity of plants entering the container at the distillation of a batch.

Prior to processing, the main physical characteristics of plants used for experimentation were determined by measurements or by visual assessment. The data obtained are presented in the table below

Table:2 Main physical characteristics of plants used for experimentation: Lavender, Sage, Mint

Name of the plant	U.M.	Lavender	Sage	Mint
Humidity	[%]	10,17	10,25	9,15
Hectolitic mass (in bag)	[kg/m <sup>3</sup> ]	aprox. 52	Aprox. 22	aprox. 45
Average plant size	[cm]	24 ÷ 28	30 ÷ 40	20 ÷ 22
Content of impurities	[%]	-	cca. 0,5	cca. 1
The degree of depreciation	[%]	-	-	cca. 3
Average batch size	[kg]	14	10	26

### 3. RESULTS

During the operation of the plant, the parameters of the distillation process were permanently monitored by the measuring apparatus and their variation over time was recorded. The table below shows the average values of the technological parameters recorded for the three types of distilled plants after adjustments and stabilization of the distillation process.

Table:3 Measured values and characteristics of Lavender, Sage, Mint

No. crt.	Characteristic	U.M.	Measured value		
			Lavender	Sage	Mint
1	The size of the batch of plants	kg	14	10	26
2	Steam pressure	bar	0,6	0,6	0,7
3	Steam temperature (saturated)	°C	112	112	115
4	Vapor temperature at condenser inlet	°C	98-99	99-100	98-99

No. crt.	Characteristic	U.M.	Measured value		
			Lavender	Sage	Mint
5	Condensation temperature	°C	60-65	60-70	55-60
6	Coolant water temperature at condenser inlet	°C	18	19	21
7	Coolant water temperature at condenser outlet	°C	55-60	60-70	60-65
8	Cooling water pressure at the condenser inlet	bar	0,3	0,2	0,3
9	Coolant water pressure at the condenser outlet	bar	0,15	0,1	0,15
10	The amount of cooling water used	l	320	305	330
11	The average flow rate of cooling water	l/min	3,6	3,7	3,3
12	The duration of the distillation process	min	90	90	90

From the analysis of the data presented in the table above, the following conclusions can be drawn:

The vapor temperature at the condenser inlet is too high, sometimes even at 100 °C. This is explained, on the one hand, by the fact that the plants used have been very dry and have not absorbed heat and for evaporating the water contained therein, which would have led to the cooling of the steam.

Due to the rigidity of the dried plant stems, uniform plant mass densification in the container was not achieved and, instead of representing a hydraulic resistance to the flow of steam, the plants allowed it to create flow channels. Therefore, the distillation of the plants in the container was only partially done, which is reflected in the rather low extraction rate. In order to homogenize the vegetal mass in the container, it is necessary to pre-strain the strains, especially the most rigid ones.

We assume that this problem does not arise in the distillation of freshly harvested plants that can be arranged much more compactly in the container.

The condensation temperature as well as the cooling water temperature at the condenser outlet were too high compared to the admissible values and therefore the extraction rate of the volatile oils was relatively low. In order to achieve a clear layering and a good separation of the water in the pot, the literature recommends that the condensate temperature should not exceed 45 °C.

This temperature could not be obtained because the condenser cooling water flow was insufficient and a balance between the vapor and the cooling water flow could not be achieved except at very low steam flows. T

he plant batches used in the experiments were quite different in size due to different characteristics, but also to the degree of loading of the container. The smallest processed batch was that of sage, at which the lowest bulk density was measured.

#### 4. CONCLUSION

It can be considered that under the conditions of complete filling of the distillation vessel and the proper preparation (grinding) and uniform compaction of the vegetable mass, the average size of a batch of processed dry plants is at least 25 kg and for fresh and higher plants.

But additional plant preparation is reflected in the longer duration of the distillation cycle. The average processing time of a batch of dried plants is 90 ... 120 minutes, which includes also the auxiliary time required to prepare the plants, as well as the loading and unloading of the distillation vessel. This means that the plant allows the distillation of 4-5 batches of plants in a normal exchange of 8 hours, ie 80-100 kg of dried plants. For fresh plants the processing capacity will certainly be higher.

## REFERENCES

- [1]. Banu C. and others. „*Manual of the Food Industry Engineer*” Vol. I, Technical Publishing House, Bucharest, 1998
- [2]. Douglas M., Heyes J., Smallfield B. “*Herbs, spices and essential oils: post-harvest operations in developing countries*” Publishing Management Service, Information Division, FAO 2005,
- [3]. Ferhat M.A., Meklati B.Y., Smadja J., Chemat F. “*An improved microwave Clevenger apparatus for distillation of essential oils from orange peel*” Journal of chromatography. A, April 21, - Volume 1112, Issue 1-2, 2006.
- [4]. MacTavish H., Harris D. “*A case study comparing non-UK lavender/ lavandin production and peppermint/spearmint production with UK production techniques and costs*” ADAS Consulting Ltd., January 2002.
- [5]. Moța C., Roșu A., Câmpeanu Gh. „*Bioactive compounds of plant origin. Biotechnological approaches*” University of Agronomic Sciences and Veterinary Medicine Bucharest, Faculty of Biotechnologies.
- [6]. Rășenescu I. „*Operations and machinery in the food industry. Vol. II*” Technical Publishing House, 1972
- [7]. Rus F. „*Basics of Food Industry Operations*” Transilvania Publishing House, Brașov, 2001
- [8]. Tannous P., Juliani R., Mingfu Wang, Simon J. “*Water balance in Hydrosol Production Via Steam Distillation*” The State University of New Jersey, February 09, 2004.
- [9]. PN 06-20 03 04 “*Research, scientific substantiation and optimization of the technology and a plant for the extraction of volatile oils in plants, for the efficient use of local agricultural products*” INMA Bucharest branch Timisoara, 2007.

# THE ROLE OF ECO – MARKETING STRATEGIES CONCERNING SUSTAINABLE DEVELOPMENT OF ROMANIAN TOURISM

Adrian Măzărel<sup>1</sup>, Laura Cismaru<sup>2</sup>, Adriana Elena Boeriu<sup>3</sup>, Cristina Maria Canja<sup>4</sup>  
Transilvania University of Braşov, Romania  
Department for Engineering and Management in Food and Tourism

## ABSTRACT

The ability of the tourist destination to remain competitive against all problems, the ability to attract visitors for the first time and their loyalty, the effort to remain unique from the cultural point of view and to be in constant balance with the environment represent the most important landmarks of sustainable tourism. As a micro-level perception, within the hospitality structures, environmental activities generate considerable tangible benefits, and beyond the economic efficiency, it creates the image of an eco-friendly business. The present study is emerging as an analysis of the needs of the business environment concerning the hospitality area in Centre Region of Romania regarding the capitalization of the eco potential at the level of the enterprise. The conclusions of the study reflect the top management of hospitality companies regarding the implementation of an environmental management system, the utility of an eco-label and the development of a strategy for the dissemination of good environmental practices among staff, customers and suppliers. (w-151, c-960).

**Key words:** sustainable tourism, eco - marketing, environmental management system.

## 1. INTRODUCTION

Tourism is one of the economic fields that is directly related to the major objectives of territorial development: sustainable development, all levels economic competitiveness, social cohesion (interaction of local communities with tourists, access to tourism for disadvantaged groups), development of new technologies. In the view of the World Tourism Organization (WTO), sustainable tourism means the ability of the tourist destination to remain competitive against all problems, to attract visitors for the first time and to attract them to become loyal afterwards, to remain unique from the cultural point of view and to be in constant balance with the ambient environment.

The origins of the sustainable development concept are derived from Brundtland Report (1987), World Environment and Development Commission (WCED), which defines four fundamental principles - Strategic planning and interaction between sectors, Importance of preserving the main ecological processes, The need to preserve both human and human biodiversity, Assume and avoid resource depletion.

A nationally recognized definition issued by the Ecotourism Association of Romania, adopted after the WTO definition, is that ecotourism is a form of tourism where the main objective is to observe and to realize the value of local nature and traditions and to meet the following conditions: to contribute to the preservation and protection of nature, to use local human resources, to have educational character, respect for nature - the awareness of tourists and local communities, to have minimal negative impact on the natural and socio-cultural environment

Sustainable tourism strategy involves three important aspects: quality, continuity and balance. Sustainable tourism must provide a valuable experience for visitors, while improving

---

<sup>1</sup>Braşov, 148, Castle Street, email: mazarel\_adrian@yahoo.com

the quality of the host community's life and protecting the environment, the continuity of existing natural resources and the preservation of cultural heritage, a balance between the needs of the tourism industry, ecologists and the local community. Tourism contributes decisively to reducing urban/ rural fadeaway, economic growth in economic decline areas (mountain areas, peripheral areas), contributing to territorial cohesion.

Environmental aspects involve planning, arrangement and responsible tourism exploitation that should be integrated in the durable development strategy of the area, region or country.

At the microeconomic level, any economic entity in the tourism industry, besides its major goal - ensuring economic profitability, has as main objectives efficient integration into the community, seeking to achieve an adequate level of environmental protection activity. According to many respondents, it is still not known whether it is a commitment to society, compliance with legislation or just a marketing strategy for a proper image that could provide market share. It is known that the level of competitiveness of any economic agent is directly proportional to its ability to provide the market with quality and environmentally clean products/ services, but there is no certainty of compliance to many of those who use it.

Environmental Management Systems (EMS) are developed on the basis of several criteria that ensure the activity is conducted in an environmentally friendly manner, and eco-management brands are a prestige for companies that implement them. Tourists appreciate more business when they are conducted in an environmentally friendly way, certified by eco certificates. The criteria of environmental standards offer the guarantee of ecological business / activities, reduce waste, save energy, reduce pollution.

For Europe, tourism operators can confirm that businesses are sustainable when it comes to complying with the ISO 14000, ISO 26000, EMAS (Eco-Management and Audit European), Eco-label, Green-key, Green Globe, Travelife, Green Tourism, Member of the International Tourism Partnership (ITP) Certification NO CO<sub>2</sub>.

Both the Community Eco-Management and Audit Scheme (EMAS) and the ISO 14001 standard have the common objective of ensuring sound environmental management. The European Commission has recognized that the ISO 14001 standard may be a milestone for EMAS participation, the requirements of the EN ISO 14001:2004 environmental management system being an integral part of EMAS III. The adoption of ISO 14001 as an element of the EMAS management system will allow organizations to progress from ISO 14001 to EMAS without useless effort duplicating.

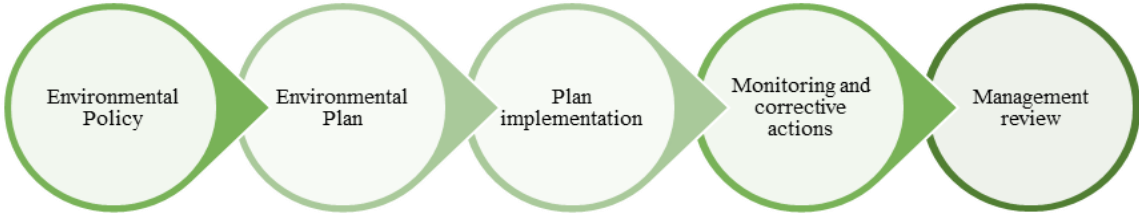

Fig. 1. ISO 14001 diagram

Standards in the ISO 14000 family cover a five action line: environmental management systems, environmental audit, assessment of the protection of human communities against adverse industrial activities, environmental classification, life cycle assessment of products and services. These standards define models of environmental management systems that can be implemented by an organization for internal or external purposes, provide the tools necessary to assess the compliance of the environmental management system with the chosen

reference, environmental performance assessment, preliminary analysis and environmental assessment of the organization's sites.

The transition from ISO 14001 to EMAS can be done easily, obtaining ISO 14001 certification means that the most important steps have already been taken to register under EMAS. Through additional requirements are included: initial environmental review, government approval for legal compliance of employers and openness to the public: a verified environmental statement. Implementation of an environmental management system has begun to be a major concern for many organizations. Being aware of the benefits of the organization through the introduction of competitive environmental management, they have increasingly allocated more financial, material and human resources to build such a management system. Environmental activities generate tangible benefits such as reduced running costs (for example due to improved energy efficiency of the building). In addition, they improve their competitiveness by implementing modern technical solutions that enable better ownership and staff management. Functioning according to the idea of sustainable development, it creates the image of an ecological business and increases the attractiveness of the region, which translates into the interest of tourists for unity.

Ecommerce aims to define, address and interrelate areas such as product sales, environmental protection, consumer education, etc. Ecomarketing attempts to present a new philosophy on the way in which production and consumption unfold, philosophy that puts the element of education as a central issue of its concerns. According to the results of research currently available, tourists are willing to choose tourist facilities that can demonstrate their environmental efforts, or have certificates attesting compliance with environmental management standards.

## **2. THE PURPOSE OF THE STUDY**

As there is a low visibility of eco-brands in the promotion of tourist units, it was considered important to investigate and evaluate perceptions of operational management, sustainable development, environmental management systems, eco-brands and ecomarketing strategies developed. The study was based on qualitative research, focus group, realized with the involvement of the master students from the study program Management in Hospitality and Eco-Tourism of the Faculty of Food and Tourism in Brasov. 5 interviews were planned in Brasov, Sibiu, Alba Iulia, Tusnad, Covasna, Târgu Mureș, with 74 persons with management positions in the operational management team of hotel/ tourist accommodation units, classified from 2 to 4 stars, according to Order 65/2013.

## **3. RESULTS AND DISCUSSIONS**

At the level of the tourism company, the marketing strategy capitalizes on the essential elements for consumers - the image and the benefits of the tourist destination and the strength of the brand built around the infrastructure classified according to the methodology in force. Other elements such as the quality/ service marks offered to the market (ISO 9001), the trade marks (Booking, TripAdvisor), the food safety marks (ISO 22000/ HACCP), the environmental respect (ISO 14001/ EMAS) Occupational Health and Safety (OHSAS) are more or less known logos. For an effective communication should be developed a strategy of marketing planning, individualization needs to be done, strategies and channels of information must be carefully selected and specific. The coherence and capability of marketing strategies/ programs depend on how the tourist product is viewed and its valences correlated with customer expectations. Ecological aspects of tourism, activities carried out according to the principles of sustainable development, preservation of cultural and natural heritage, care for



the being - outline a symbolic value of tourism products. The involvement of the tourism company in sustainable development must be organized and structured in effective messages, focused on customer - driven channels.

The methodology of the qualitative research conducted allowed a series of elements:

- identifying the perceptions of the employees involved in coordinating the main management processes in tourism companies;
- assessing attitudes of hospitality organizations towards environmental protection;
- knowledge of topical concepts such as: environmental management, environmental management systems or ISO 14001, EMAS, eco-branding, eco-marketing;
- identifying the factors that determine the implementation, or not, of an environmental management system.

Among the 74 people participating in the study, coming from different units from the 5 representative cities in the center area, only 8% have an idea how an environmental management system works, because the organizations they are based on have an EMS implemented/ certified. Most consider that an EMS implemented is less relevant, as long as there are tasks of an environmental representative covered by another post, if there are internal instructions and actions to provide the company with non-conformities to specific legislation. EMAS is inoperable in this case, ISO 14001 was easier to implement with ISO 9001 implementation, with specialist support from consultant firms. Low levels of eco-marketing and environmental management systems have been found to be lacking, due to lack of specific professional training, but also a limited degree of confidence in the power of ecomarketing to increase customer numbers or to stabilize customers over a period of time. The communication of ecological activities is not enough, represented by short messages sent directly through leaflets/ signs placed in the info-advertising materials at the receptions or the room. In fact, investments and environmental activities are more extensive, with evidence of domestic water treatment, air filtration, waste oil collection, thermo-sound insulation of buildings, the use of energy-efficient equipment, the use of green energy sources, selective collection of waste.

The reasons why EMAS/ EMS according to ISO 14001 are not definitively in tourism companies are diffused as operative and financial. The main identified reasons that do not wish to implement/ certify an EMS are:

- "We consider that there are no advantages for our kind of business";
- "Unrealistic, it does not bring a specific, guaranteed profit";
- "We do not have people prepared to manage an Environmental Management System";
- "High cost of consulting services";
- "High Costs for Certification Services";
- "The financial situation of the firm does not allow any investment";
- "Lack of Compliant Infrastructure";
- "Structure of the reduced organization";
- "Too much bureaucracy";
- "Many papers to fill in (forms/ recordings)".

Even if there were several reasons for not certifying an EMS, it is still aware of and reflects on the benefits that can be gained by the organization:

- Image Vector;
- Increasing customer satisfaction;
- Employee responsibility, improve communication and motivation;
- Increasing success in public auctions by differentiating from competitors;
- Improving productivity and efficiency;
- Identification of non-compliant activities and products;
- Increase product value in customer understanding;

- Coordinating and managing the organization's entire eco-activities in a systematic and planned manner;
- Cost reduction;
- Better measurement of environmental performance.

The eco-related aspects of the marketing strategies of the units in the analyzed sample are the actions against food wastage, the use of signaling to reduce energy consumption (paneling in common elevators/ rooms/ spaces), the use of signaling to reduce the consumption of detergent, water, washing linen/ towels and use of green energy signaling.

Revision of international ISO standards, including ISO 14001, has proven to be another impediment to the decision of designing, implementing, and certify a management system in the tourism business area. The adoption of new requirements of the standard and the new recommended structure of an environmental management system could create difficulties among specialists/ auditors without a prior training session.

According to the majority of respondents, the need for external expertise was identified, with the involvement of a non-profit tourism organization or the National Tourism Authority. A joint project to support Central Region operators would be appropriate for the sustainable development of the area. The project's contribution could target financial issues, which would subsidize consultancy costs and certification fees, access and support for specialists to shift the know-how needed to develop eco-marketing strategies. The present study provided information on the tourism market of the center area that justified the justification of a funded project funded by POCU / 227/3/8 Mysmis 117664, which was declared admitted and will be implemented in June 2018. The project aims at developing performance professional and competence enhancement for 510 people as entrepreneurial managers and employees in human resources departments by providing customized training programs and other activities, model courses, innovative and sustainable relevant practices geared to increasing mobility, sustainable development opportunities and the degree of adaptability of the activity in the sector with competitive potential Tourism and Ecotourism in the Central Region.

Organizations consider certification as "a public tool for independent and rigorous calibration of environmental standards," and that certification would enable existing customers to be conserved and increase their chances of attracting new customers. However, there occurred some inadvertences, which did not necessarily relate to standards, but rather to their application. Most of the findings are related to documentary issues, excess in this sense ruining the effectiveness of the approach to an EMS.

#### **4. CONCLUSIONS**

The foundation of the company's ecomarketing strategy involves adapting and adopting innovative elements in its culture and practice, defined by technological excellence. Technological excellence, defined as a form of management that relates to innovation, environmental protection and profitability, is, in fact, the result of a desire to be a leader in the field of environmental protection. Also, technological excellence requires the use of organic management and marketing as indispensable tools in the competitive struggle. This "ecological competitiveness" implies the implementation of concrete actions, such as: provision, anticipation of changes, obtaining an "ecological reflex" by: designing a typical management system for each company, integration of ecological concerns among the performance criteria of managers; to raise the awareness of the company's staff to the current concerns and trends in the field; to include in the professional training programs the environmental protection elements.

Ecological information is an element that involves at least two components: From a technical point of view, information transferred to users or interested persons must be of good

quality, transmission can be done on any form of support, communicating with the public and changing the mindset in relation to the environment. Organic behavior is only obtained by knowing the issue in its totality and complexity.

## References

- [1] Ionciă Maria (coord), „*Strategia de dezvoltare a sectorului terțiar*”, Editura Uranus, București, 2004.
- [2] Stănciulescu Gabriela, „*Managementul turismului durabil în centrele urbane*”, Editura All Beck, București, 2004.
- [3] Costencu M, „*Tendințe de piața turismului durabil*”, Revista de turism nr.3, 2010.
- [4] Bran Fl., T. Simon, P. Nistoreanu – „*Ecoturism*” – Editura Economică, Bucuresti, 2000, 2.
- [5] Glăvan V., „*Turismul si protectia mediului – probleme prioritare ale României viitoare*”, în Turismul în contextul dezvoltării durabile, A.S.E. Bucuresti, 2002.
- [6] UNEP, Green Economy and Trade. Trends, Challenges and Opportunities, pag 275 <http://www.unep.org/greeneconomy/Portals/88/GETReport/pdf/FullReport.pdf>, 2013.
- [7] Ministère de l'Environnement, de l'Energie et de la Mer, <http://www.developpement-durable.gouv.fr/-Tour-d-horizon,2745-.html>
- [8] Acces la dreptul Uniunii Europene, <http://www.eur-lex.europa.eu/>.
- [9] Comisia Europeana, [http://ec.europa.eu/environment/index\\_en.htm](http://ec.europa.eu/environment/index_en.htm).
- [10] Comisia Europeana, <http://ec.europa.eu/clima/>.
- [11] Comisia Europeana, [http://ec.europa.eu/green-papers/index\\_en.htm](http://ec.europa.eu/green-papers/index_en.htm).
- [12] Comisia Europeana, [http://europa.eu/eu-law/legislation/index\\_en.htm](http://europa.eu/eu-law/legislation/index_en.htm).
- [13] Ministerul Slovaciei, <http://www.mos.gov.pl/>.
- [14] Ministerul Poloniei, <http://www.ekoportal.gov.pl/home/index.html>.
- [15] Guvernul Spaniei, [http://www.boe.es/diario\\_boe/](http://www.boe.es/diario_boe/).
- [16] Guvernul Italiei, <http://www.minambiente.it/archivionormative>.
- [17] Guvernul Belgiei, <http://www.moew.government.bg/>.
- [18] Guvernul Germaniei, <http://www.umweltbundesamt.de/>.
- [19] Guvernul Germaniei, <http://www.izu.bayern.de/>.
- [20] Guvernul Frantei, <http://www.vedura.fr/developpement-durable/reglementation>.
- [21] Guvernul Frantei, <http://www.developpement-durable.gouv.fr/-Tour-d-horizon,2745-.html>.
- [22] Comisia Europeana, [http://responsalliance.eu/rplearn/?page\\_id=1135&lang=ro](http://responsalliance.eu/rplearn/?page_id=1135&lang=ro).

# THEORETICAL ELEMENTS FOR THE CONSTRUCTIVE OPTIMIZATION OF THE AGRO-FOOD PRODUCTS RECIPIENTS

Ph.D. Stud. Eng. Gabriela Milian<sup>1</sup>, Prof.Ph.D.Eng. Sorin-Stefan Biriş, Prof.Ph.D.Eng. Victor Moise  
University "Politehnica" Bucharest, Faculty of Biotechnical Systems Engineering, Romania

## ABSTRACT

The paper presents the results and calculation methods to determine the constructive parameters of the containers, more precisely the determination of the minimum surface area for a given volume using analytical calculation algorithms with Lagrange's multiplier method. These research has been highlighted using Matlab and SolidWorks. The purpose of this paper is to highlight shortening design and obtaining reliable solution at a low cost.

**KEYWORDS:** Minimum surface area, Container, Numerical analytical methods, Agro-food products, Solidworks, Mathcad , FEM

## 1. INTRODUCTION

Shorten design times and get a reliable solution at a low cost led to research on optimization methods. What has become indispensable in making the right decision on the solution to be adopted to the manufacture of containers for agri-food products.

Analysis of the research stage in the field of constructive optimization containers for agri-food products (tanks-container) is made for both shipping and storage vessels liquid materials, as well as for those in solid state (granular material, powdery material).

Agro-food products that can be stored , stored and transported using tank containers are: milk, wine, honey, alcohol of various concentrations, seeds (hemp, sunflower, e.g.), cereals (wheat, barley, oats), e.g. [8]

Agro-food products such as milk and dairy products are the basic foods in human food, being considered the most complete natural food of animal origin, due to its complex and balanced nutritional composition. Chemical composition of milk varies according to species, race, food, age, housing conditions, animal health status,e.g. [8]

The main milk components are: water (87.5%, 12 - 13% total dry substance), fat (3.8%), colorants, gases and immune bodies (antibodies). Appreciation of grain quality used to obtain the flour is made according to physical criteria, chemical and technological processes. The quality of the cereals received at the mill must correspond to the minimum conditions established by state standards. Quality assessment is based on: general indices and technological attributes of cereals. [8]

General indices refer to the senses of the cereals (appearance, color, smell, taste).

Technological indices refer to how the technological process is being carried out for the preparation of flour (the size of the grains, the degree of humidity, mineral content, grain hardness). Finally he concluded that the maximum force to which the half-full tank is subjected may be significantly less than half the force to which the full tank is subjected. [8]

All of these features and physico-chemical properties of these agri-food products determined the design and the implementation of some optimal constructive features , so these their property

is not damaged during storage and transport, reaching a good condition to the recipient and the user.

Over time, finding the right and reliable solution in the field of storage containers and transportation of agri-food materials led to researches such as: George W.Housner (1963) discussed the relation between the motion of the water with respect to the tank and the motion of the whole structure respect to ground. He has considered three basic conditions of tank for the analysis i.e fully filled, empty and partially filled. He said that if water tank is fully filled condition i.e without free board then the sloshing effect of water is neglected and if the tank is empty then there is no sloshing effect. In the above two cases water body in the tank will behave as one-mass structure. But in third case i.e water tank is partially filled, the effect of

---

<sup>1</sup>No. 313 Splaiul Independentei, tel: 0766 453 970; e-mail:[gabi\\_isb@yahoo.com](mailto:gabi_isb@yahoo.com)

sloshing should be considered. In the case the water body will behave as two-mass structure. Finally he concluded that the maximum force to which the half-full tank is subjected may be significantly less than half the force to which the full tank is subjected. [2]

R.Livaoglu (2007) evaluate the dynamic behaviour of fluid-tank-soil/foundation system with a simple and fast seismic analysis procedure. Housner's two mass approximations are used for fluid and cone model is used for soil/foundation system. This approach can determine; displacement at the height of the impulsive mass, the sloshing displacement and base forces for the soil/foundation system conditions including embedment and incompressible soil cases. In addition to this, some comparisons are made on base forces and sloshing responses for the cases of embedment and without embedment conditions by changing soil/foundation conditions. The results shows that displacements and base shear forces are generally decreases with decreasing soil stiffness. However, embedment, wall flexibility and SSI did not affect the sloshing displacements. [4]

M.Moslemi and M.R.Kianoush(2012) investigates the dynamic response of cylindrical open top ground-supported tanks. The main focus of this study is to identify the major parameters affecting the dynamic response of such structure and to address the interaction between these parameters. Parameters considered for the study are sloshing of liquid free surface, tank wall flexibility, vertical ground acceleration, tank aspect ratio, and base fixity. Dynamic results obtained from rigorous FE method are compared with those obtained based on ACI code provisions. Both time history and free vibration analyses are carried out on concrete tank models with different aspect ratios. It is concluded that the current design procedure based on ACI code provisions in estimating the hydrodynamic pressure is too conservative. Finite element method can be accurately employed in both free vibration and transient analysis. [3]

M.V.Wghmare and S.N.Madhekar(2013) studied behaviour of tank under sloshing effect. Different parameters have been considered such as height of container, depth of fluid in tank (30%, 50%,70% and full) and height of staging e.g. It is observed that sloshing of fluid in tank depends not only on the volume of fluid in tank but also on staging height and aspect ratio (h/D). [5]

Dona Rose K.J. and Sreekumar M. et al. (2015) investigates the behaviour of overhead tanks under dynamic loading. Tanks of various capacities with different staging height is modelled using ANSYS software. The analysis is carried out for two cases i.e, tank full and half level condition. The sloshing effect along with hydrostatic effect are considered for the study. It is concluded that the peak displacement from the time history analysis increases with staging heights. But the displacement first decreases and then increases with tanks are taken into account incorporating wall flexibility. The results show that the wall flexibility and fluid damping properties have a major effect on seismic behaviour of liquid tanks and should be considered in design criteria of tanks. [1]

Pavol Lengvarsky (2015) static structural analysis of the tank as part of the truck body was performed. The tank was modelled from the stainless steel as 3D body. The finite analysis was performed by commercial computer program. Three different thicknesses (3mm,5mm,8mm) were taken into account. The displacement plots and the von Mises stress plots served for comparison of results. Displacements and stresses were very high in basic design so seven modified structures were proposed in order to find the best one. All results of these variants were given in tables. For the 7<sup>th</sup> variant, which was chosen for manufacturing, we got the maximal displacement 2.791mm,1.480mm,1.047mm and the maximal von Mises stress 145.379Mpa, 68.091Mpa, 49.252Mpa for thickness 3mm,5mm and 8mm, respectively. [3]

A tank is formed of one or more cylindrical parts closed to the extremities (watertight tanks) whose capacity is over 1m<sup>3</sup>, mounted on the same frame of resistance, complete with service equipment.

The structure of the tank includes:

- consolidation and stabilization elements: tailing delimiting partition walls (when it is composed of several tanks);
- fixing and tightening elements of the tank;
- fittings and accessories (railings, ladder and bridge, protection box for valves drain / supply and pneumatic control panel) - service equipment. (Figure 1) [7]

Tanks, attached devices and their service equipment and the structure are designed to resist without losing the content to static and dynamic demands under normal transport conditions and to minimum forces imposed according to international and national design standards IMDG,ADR,RID,e.g.

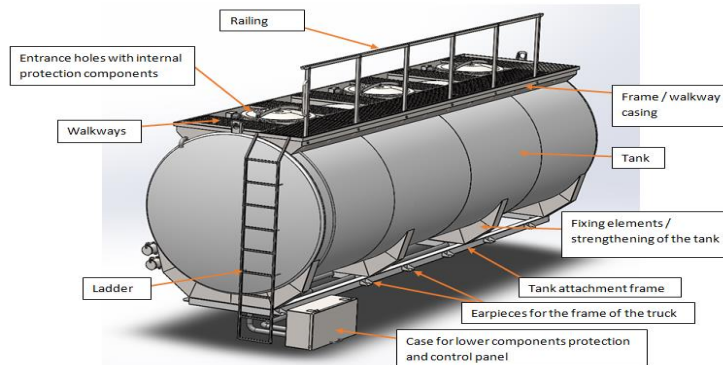

Figure 1. Representation of the construction model and the components of the tank [7]

The static and dynamic solitaires that may appear in these containers and which are considered in research studies are:

- the action and distribution of forces inside the containers on the vessel walls (internal pressure, external pressure) on the connections between the recipient and the installations with which it is connected respectively on the material from which it is made;
- he vibrations occurring during the loading and unloading of the material in the vessel over the container hold;
- the action and distribution of external pressures on recipients such as wind, earthquake and other accidental interference that may cause their damage.

The bodies of the tanks and fastening devices in the case of the maximum permissible load must bear the action of the following forces:

1. the direction of movement: proportional to total double mass;
2. horizontally at a right angle in the direction of movement: proportional to total mass;
3. vertical from bottom to top: proportional to total mass;
4. Vertical from top to bottom: proportional to total double mass.

Walls, beams and lids of tank bodies, with round cross section, with a diameter of up to 1.80m<sup>2</sup>, will have a thickness of at least 5mm, if they are made of soft steel or equivalent thickness, if they are made of other metal. In case of exceeds 1.80m<sup>2</sup> this thickness will be increased to 6mm, if the tank is made of soft steel, with the exception of tankers transporting granular and powdery materials.(see Tabel 1). [7]

Tabel 1:Variation of the minimum thickness of the tank walls according to diameter and material

Grosimea minimă a rezervorului	Diametrul rezervorului	≤ 1,80 m	> 1,80 m
		Oțeluri inoxidabile austenitice	2,5 mm
	Oțeluri austeno-fertice inoxidabile	3 mm	3,5 mm
	Alte oțeluri	3 mm	4 mm
	Aliaje de aluminiu	4 mm	5 mm
	Aluminiu pur de 99,80%	6 mm	8 mm

Tanks will be constructed and manufactured in accordance with the provisions of the approved technical regulations so as to the choice of the material and the determination of the thickness of the walls are made according to temperatures of design and operating.

These tank containers are made of corrosion resistant materials with certain physico-chemical properties that do not allow their interaction with the fluids transported to alter their quality.

Tank are constructed from aluminum, carbon steel, stainless steel, or fiberglass-reinforced plastic, depending on the product being transported by the truck.

Food grade tank-container are required to meet stringent safety and sanitation codes before they are certified to transport foods.

In the paper are presented the results and the calculation methods for determining the constructive parameters of the agro-food containers, more precisely determining the minimum surface area for a given volume using Matlab program.

In order to achieve optimal optimization of the construction parameters, they have been taken into consideration both dynamic forces, and also static forces, what works on containers.

With the help of the results obtained from the analytical calculation algorithms by the method of Lagrange's multipliers, use in Matlab program, they can be modeled in 3D Solidworks. Which leads to the exact observation of problems and restrictions, what can appear in designing agri-food containers subjected to both static solitaire, as well as dynamics.(see Figure 2 and Figure 3) [1] [9]

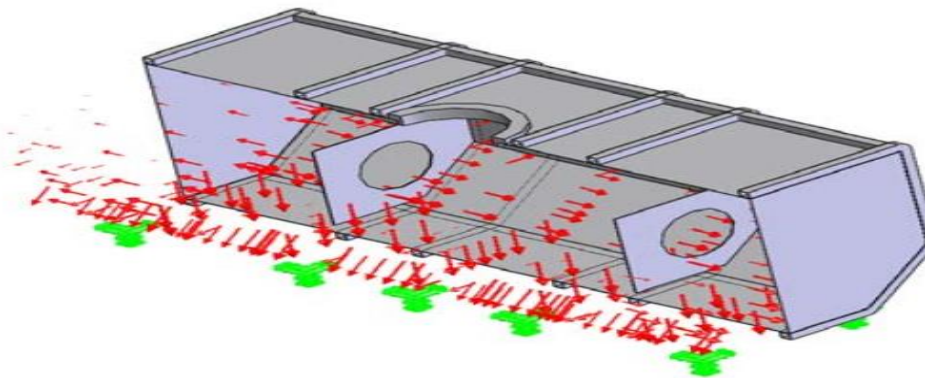

Figure 2. The 3D model of the agro-food tank

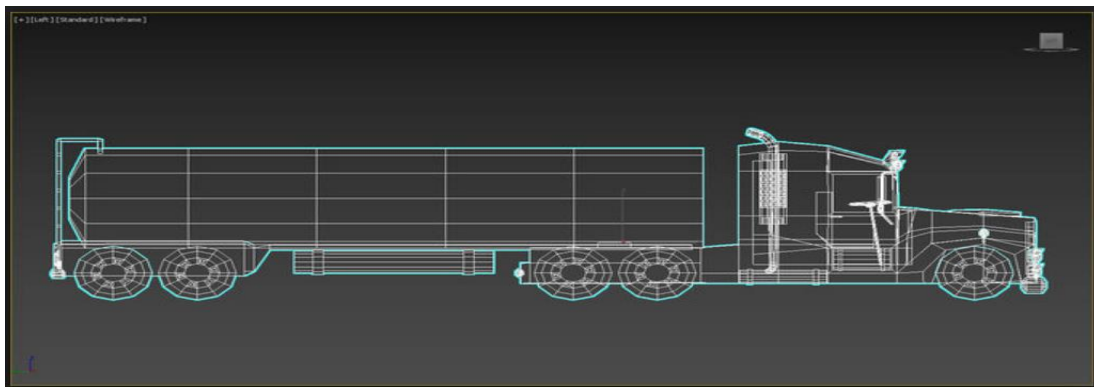

Figure 3. The 3D model of the agro-food tank

## 2. METHODS OF ANALYSIS AND OPTIMIZATION

Determination of the minimum surface area of the agro-food containers for a given volume by the Lagrange multipliers method using the Matlab program.

Considering a cylindrical (tank) container having the geometric shape of the hemispherical beads, is required to determine the minimum area for a given volume.(see Figure 4) [6]

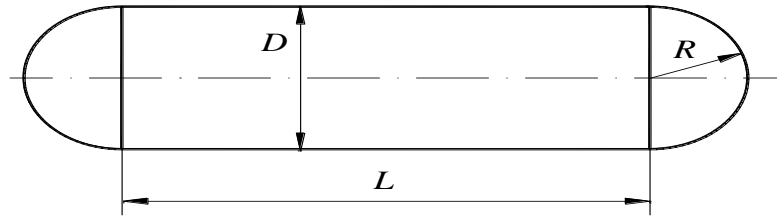

Figure 4. Tank container with hemispherical beads

The total surface of the tank is:

$$S = 2\pi RL + 4\pi R^2 \quad (1)$$

The volume of the tank is:

$$V = \pi R^2 L + \frac{4}{3}\pi R^3 \quad (2)$$

Relationship (1) is the objective function of the problem, and relationship (2) is the equality-type restriction. Also the conditions of non-negativeness of the variables also exist.

The mathematical model of the problem is:

$$\text{Minim}(S) \quad (3)$$

with restrictions:

$$\pi R^2 L + \frac{4}{3}\pi R^3 - V = 0 \quad (4)$$

$$L > 0; R > 0 \quad (5)$$

If the notations are made  $x_1 = L, x_2 = R$ , the mathematical model becomes:

$$\text{Minim}(2\pi x_1 x_2 + 4\pi x_2^2) \quad (6)$$

with restrictions:

$$\pi \cdot x_2^2 \cdot x_1 + \frac{4}{3}\pi x_2^3 - V = 0 \quad (7)$$

$$x_1 \geq 7; x_2 > 0. \quad (8)$$

where : L - is the length of the tank;

R- is the beam of the tank.

If the Lagrange multipliers method is used, to determine the minimum surface of the tank at a given volume, the Lagrange function of form is formed:

$$L(x_1, x_2, \lambda_1, \lambda_2, w_1) = 2\pi x_1 x_2 + 4\pi x_2^2 + \lambda_1 (\pi \cdot x_2^2 \cdot x_1 + \frac{4}{3}\pi x_2^3 - V) + \lambda_2 (-x_1 + 7 + w_1^2), \quad (9)$$

where:  $\lambda_1, \lambda_2$  is Lagrange multipliers and  $w_1$  is variable varies.

The extreme function (9) is determined by solving the system of nonlinear equations obtained from the zero equation of the partial derivatives of the function (9), in relation to parameters  $x_1, x_2, \lambda_1, \lambda_2, w_1$ .

The partial derivatives of the function (9) have the form:

$$\frac{\partial L}{\partial x_1} = 0; \frac{\partial L}{\partial x_2} = 0; \frac{\partial L}{\partial \lambda_1} = 0; \frac{\partial L}{\partial \lambda_2} = 0; \frac{\partial L}{\partial w_1} = 0 \quad (10)$$

Applying relations (10) to function (9), it is obtained:

$$\begin{aligned} 2\pi x_2 + \lambda_1 \cdot \pi \cdot x_2^2 - \lambda_2 &= 0; \\ 2\pi x_1 + 8\pi x_2 + \lambda_1 (2\pi \cdot x_2 \cdot x_1 + 4\pi x_2^2) &= 0; \\ \pi \cdot x_2^2 \cdot x_1 + \frac{4}{3}\pi x_2^3 - V &= 0; \\ -x_1 + 7 + w_1^2 &= 0; \\ 2\lambda_2 + w_2 &= 0. \end{aligned} \quad (11)$$



Relationships (11) form a system of nonlinear equations, in the unknown  $x_1, x_2, \lambda_1, \lambda_2$  and  $w_1$ . The system of nonlinear equations (11) is solved by a suitable numerical method (Newton-Raphson, gradient, etc.)

For a tank volume  $V = 26 \text{ m}^3$  the following results were obtained (see Tabel 2):

Tabel 2. Tabel results for determination of the minimum surface area of the agro-food containers for a given volume by the Lagrange multipliers method using the Matlab program

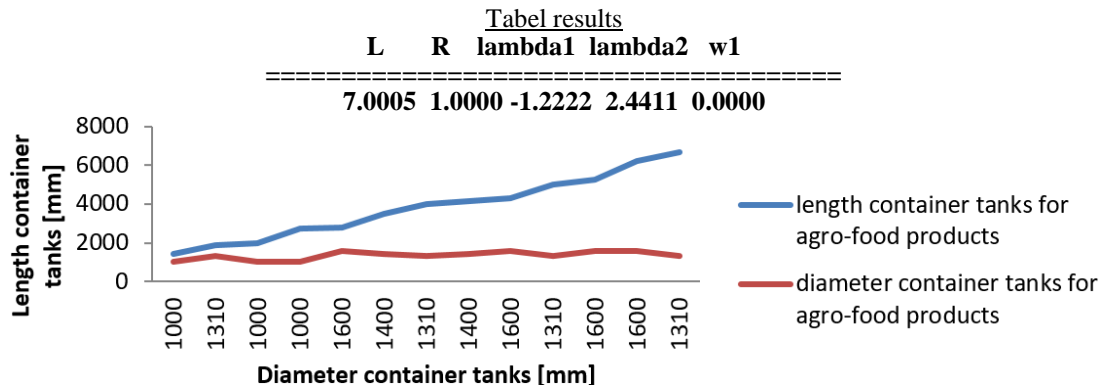

Figure 4. Results for determination of the minimum surface area of the agro-food containers with hemispherical beads

### 3. CONCLUSION

Using the numerical and analytical methods (Matlab program), the desired solution can be obtained faster than it can be traced immediately in 3D design programs, resulting in a good prototype for execution.

Finite Element Method (FEM) is simple and fast for complex geometries. By using FEM as an analysis tool, the results obtained are very close to the actual measured value with only minor deviations (measurement error).

Hence by using FEM, it's easy to predict the pressure vessel limit load closer, the damages container tank to actual measurement and it can be done at different preferred location as per requirement.

### 4. REFERENCES

- [1] Pavol Lengvarsky, Miroslav Pastor, Josef Bocko, "Static Structural Analysis of Water Tank" American Journal of Mechanical Engineering, Vol.3, No.6, 230-234, 2015;
- [2] Shilja Sureshkumar, Asha Joseph, "Review on structural performance of water tanks under dynamic loading" International Research Journal of Engineering and Technology, Vol.4, Issue 4, ISSN:2395-0056, Apr-2017;
- [3] K.J. Dona Rose and Sreekumer M. et al, "A study of overhead water tanks subjected to dynamic loads" International Journal of Engineering trends and technology, Elsevier, ISSN:344-348, 2015;
- [4] Youngi Wang and J.Y Richard Liew et al, "Structural performance of water tank under static and dynamic pressure loading" International Journal of Impact Engineering, Elsevier, ISSN:110-123, 2015;
- [5] R.Davis, H.Keith, "Finite element analysis of pressure vessels", Journal of Basic Engineering, 94(2), ISSN:401-405, 1972;
- [6] Victor Moise, Marinela Moise, Gheorghe Iaciu, "Metode de optimizare neliniara", editura Printech, Bucuresti, 2008
- [7] "Anexa regulamentului ADR si prescriptii tehnice pentru constructia, omologarea de tip a cisternelor fixe, container-cisterna a caror rezervoare sunt constituite din materiale metalice"
- [8] "Ordinul ministerul agriculturii si de dezvoltarii rurale nr.228/2017 privind Manualul de gradare pentru seminte de consum "11.07.2017
- [9] <https://videohive.net/item/truck-tank-3d-wire-frame/9423651>

# ASPECTS REGARDING MISCANTHUS GRINDING PROCESS FOR PELETIZATION/BRIQUETTING

Georgiana MOICEANU<sup>1</sup>, Gigel PARASCHIV<sup>1</sup>, Gheorghe VOICU<sup>1</sup>, Mirela DINCĂ<sup>1</sup>,  
Valentin VLĂDUȚ<sup>2</sup>, Iuliana GĂGEANU<sup>2</sup>

<sup>1</sup>University Politehnica of Bucharest, <sup>2</sup>INMA - Bucharest

## ABSTRACT

Biomass is a renewable source of energy that has an important contribution in reducing the use of conventional fuels and in reducing greenhouse gas emissions to the atmosphere. Pelleting and briquetting processes have been used for many years to produce densified biomass for fuel applications. Pellets produced from biomass (wood, energy plants and agricultural residues) present a higher energy density feedstock than wood chips or bales, and thus reduce the costs of handling, transport and storage throughout the supply chain. The aim of the present paper was to determine the energy consumption necessary for *Miscanthus x giganteus* biomass grinding using a hammer mill type MC-22 equipped with sieve with  $\phi 10$  mm orifice sizes, four types of hammers and the rotor speed ranged from 2400 rpm to 3000 rpm.

## 1. INTRODUCTION

Biomass is the third-largest energy resource in the world, after coal and oil. The most important advantages of biomass consumption are its renewability and sustainability and the fact that can significantly reduce carbon emissions comparing with fossil fuels [1]. In order to use biomass energy source effectively, the density of biomass must be increased. The biomass densification process is done by pelleting and briquetting processes. Pellets produced from biomass (wood, energy plants and agricultural residues) present a higher energy density feedstock than wood chips or bales, and thus reduce the costs of handling, transport and storage throughout the supply chain [2]. Pellets are made from dry, untreated, biomass that is hammermilled into fine pieces then reformed into small, cylindrical pellets under high pressure and temperature [3]. During storage and transportation, it is important to observe variation in the physical properties of the wood pellets, including dimension, density, moisture content and hardness. For example, moisture absorption can increase the biological degradation of biomass, this aspect leading to spontaneous combustion of wood pellets in large-scale storage and transportation [4, 5]. Size reduction is an important stage in pelleting process; this could affect the compaction, contact between particles, friction in the die and the flow rate of material [6, 7]. Hammer mills are the most suitable equipments for size reduction. There is a limitation on the size of the input material, which has to have a diameter less than 2.54 cm to be processed [8].

Lignocellulosic crops like *Miscanthus x giganteus*, which is a C4 perennial rhizomatous grass, and willow (*Salix viminalis*) can have an interesting future in European countries as energy crops [9]. Noorfidza and Muhammad [10] reported that particle size contributes to the mechanical strength of biomass pellets: biomass pellets made with smaller particle size showed high yield stress and density. They tested the particle size of biomass in range of 150-300, 300-425 and 425-600  $\mu\text{m}$ .

Chitoiu *et al.* [11] also conducted experiments regarding the grinding process of energetic willow - *Salix viminalis*. The authors concluded that the particles dimension after grinding contribute to the quality of the finished product (briquettes or pellets).

---

<sup>11</sup>Splaiul Independentei 313, Sector 6, Bucharest, 0745201365, moiceanugeorgiana@gmail.com

Daraban *et al.* [12] determined the capability of mixing *Miscanthus x giganteus* biomass with other vegetable biomass (straw, wood sawdust, or other energetic plants) to obtain briquettes and pellets. Different characteristics were studied as: percentage of variable biomass mixed with *Miscanthus* (30%, 50% and 70%), humidity variation (wt = 9 – 13%) and quality of final product. The authors reported that energy crops are suitable to be mixed with other biomass (wood or agricultural residues), in order to provide locally sustainable products (briquettes and pellets) as solid biofuel for small scale heating systems.

The aim of the present paper was to determine the energy consumption necessary for *Miscanthus x giganteus* biomass grinding using a hammer mill type MC-22 equipped with sieve with  $\phi 10$  mm orifice sizes, four types of hammers and the rotor speed ranged from 2400 rpm to 3000 rpm.

## 2. METHODOLOGY

In order to achieve the main goal of this paper, experimental research took place at INMA Bucharest. As biomass for testing, miscanthus stalks were used. The initial material was shredded when it was harvested and the particle sizes chips had an average length of approximately 125 mm. The chopped material particles were subjected to milling process using a hammer mill type MC -22 with articulated hammers, with 500 mm rotor length, hammer distribution diameter  $\phi 220$  mm, and grinding chamber diameter of  $\phi 500$  mm. The sieve used in experiments was a sieve with  $\phi 10$  mm orifice sizes.

Also, functional parameters such as rotor's speed of revolution which ranged from 2400 rpm to 3000 rpm (in steps of 150 rpm) and hammer types (A – with an edge; B – with two edges; C – with three edges and D – with beveled corners) were modified during tests. Taking the fact that dried *Miscanthus* stems are light and bulky, experiments were realized with each probe weighing 5 kg, and material moisture at grinding time had an average value of 9.74–11.05% for *Miscanthus x giganteus* biomass.

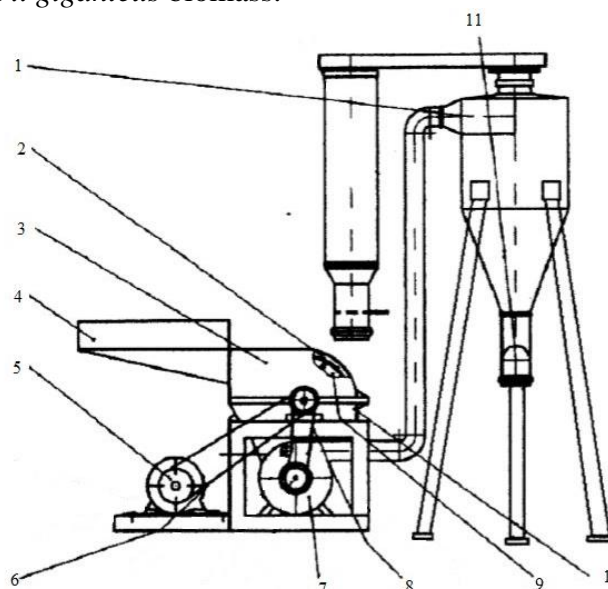

Figure 1. Constructive MC 22 hammer mill design [13]

1. calming cyclon; 2. concave; 3. hinged case; 4. feeding chamber; 5. electric motor; 6. belt conveyance; 7. exhauster 8. belt conveyance; 9. rotor; 10. fixed case; 11. bag mouth

After the end of the milling process the biomass particles resulted were subjected to a granulometric sorting process using the sieves of a classifier type AS 200 basic, the grinding time being about two minutes.

Also, the energy consumption necessary for the grinding process was researched and presented in this paper.

### 3. RESULTS AND DISCUSSIONS

In table 1 are presented the results obtained for the energy consumption during milling process after experimental research.

Table 1: Variation of grinding energy depending on the hammer mill function parameters

<b>Rotor speed of revolution [rpm]</b>	<b>Hammer type A [kJ/kg]</b>	<b>Hammer type B [kJ/kg]</b>	<b>Hammer type C [kJ/kg]</b>	<b>Hammer type D [kJ/kg]</b>
3000	59.63	102.83	94.96	71.96
2850	51.79	99.59	72.36	91.57
2700	47.73	96.19	88.19	114.21
2550	64.42	69.59	67.11	100.31
2400	35.71	97.64	96.52	88.46

In table 2 the values of the material percentages considering each classifier sieves are presented. Based on these results, using MS Excel the data was processed, thus the distribution curves of the grinded material were plotted depending on the rotor speed and on the used hammer type.

Table 2: Experimental results regarding the grinded material size distribution for the mill sieve of 10 mm

<b>Rotor speed of revolution [rpm]</b>	<b>Percentage of material in the classifier sieve [%]</b>											
	<b>Particle size &lt; 5mm</b>				<b>Particle size between 5 ÷ 10 mm</b>				<b>Particle size &gt; 10 mm</b>			
	<b>A</b>	<b>B</b>	<b>C</b>	<b>D</b>	<b>A</b>	<b>B</b>	<b>C</b>	<b>D</b>	<b>A</b>	<b>B</b>	<b>C</b>	<b>D</b>
3000	76	62	75	65	61	56	52	60	42	39	36	39
2850	63	69	73	46	48	61	64	68	45	44	34	54
2700	61	60	65	58	50	65	62	52	32	48	39	43
2550	54	54	64	59	50	60	61	59	51	45	42	61
2400	39	64	69	49	55	56	56	67	73	50	39	66

Analyzing both table 2 and figure 1, it can be seen that the highest percentage of material particles was registered for particle smaller than 5 mm. Also, when analyzing the entire particle percentage distribution on sieves from table 2, it can be said that for fraction smaller than 5 mm the percentage is higher compared to the other fractions and similar for fraction higher than 10 mm the particle distribution percentage is lower, in both cases disregarding the type of hammer used for testing. If the type of hammer is taken into consideration when analyzing the grinded particle distribution, it has to be said that type A hammer shows percentage values between 39 – 76 % comparing to hammer type C for which the percentage values distribution is between 34 – 42 %. As it can be seen for type B hammer the material percentage distribution is higher for particles smaller than 5 mm and lower for fractions above 10 mm.

In order to better understand the fraction distribution after experimental research a polynomial regression analysis was done. The type of regression was chosen so that all curves fit best and thus being able to compare to each other for every group of fractions. Also, when

applying other regression analyze it was necessary to change the type of regression each time a certain parameter was taken into consideration for analysis. As shown in figure 1 the correlation coefficient for hammer type A had values above 0.81 and for hammer type C the correlation coefficient had values between 0.56 and 0.81. The highest value for correlation coefficient was recorded for type A hammer  $R^2=0.94$ .

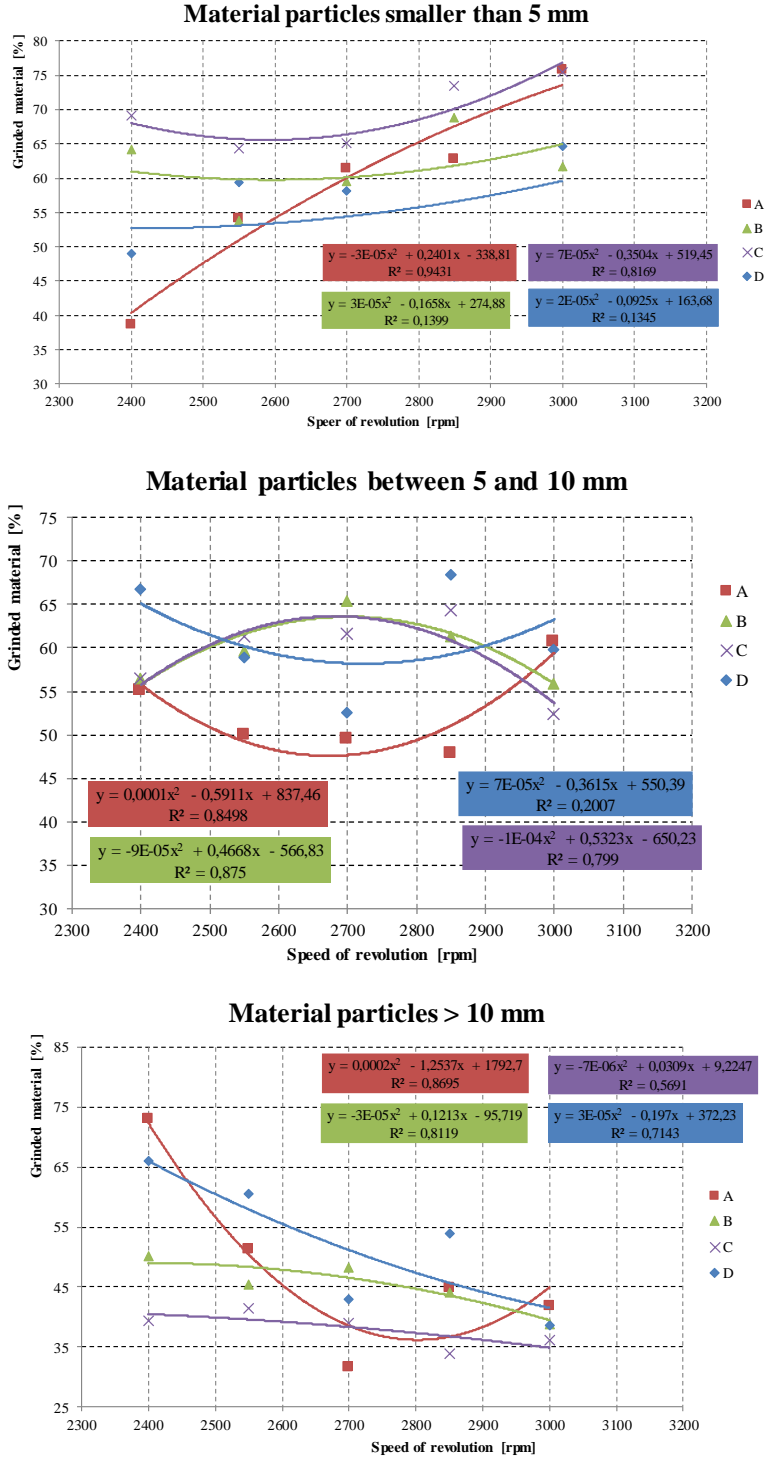

Figure 1: Particle distribution of grinded material depending on the hammer type and the hammer mill speed

Regarding aspects referring to energy consumption during milling process, the variation resulted is presented in figure 2, the data being plotted with MS Excel program. Analyzing figure 2 and also table 1, it can be said that the highest value of energy consumption was recorded for hammer type D at 2700 rpm followed by hammer type B at a speed of revolution of 3000 rpm.

If the values in table 1 are analyzed it can be seen that for type A hammer all values of the energy consumption are lower than the other types of hammers disregarding the rotor's speed of revolution.

The average energy consumption taking all function parameters into consideration is around 80.5 kJ/kg.

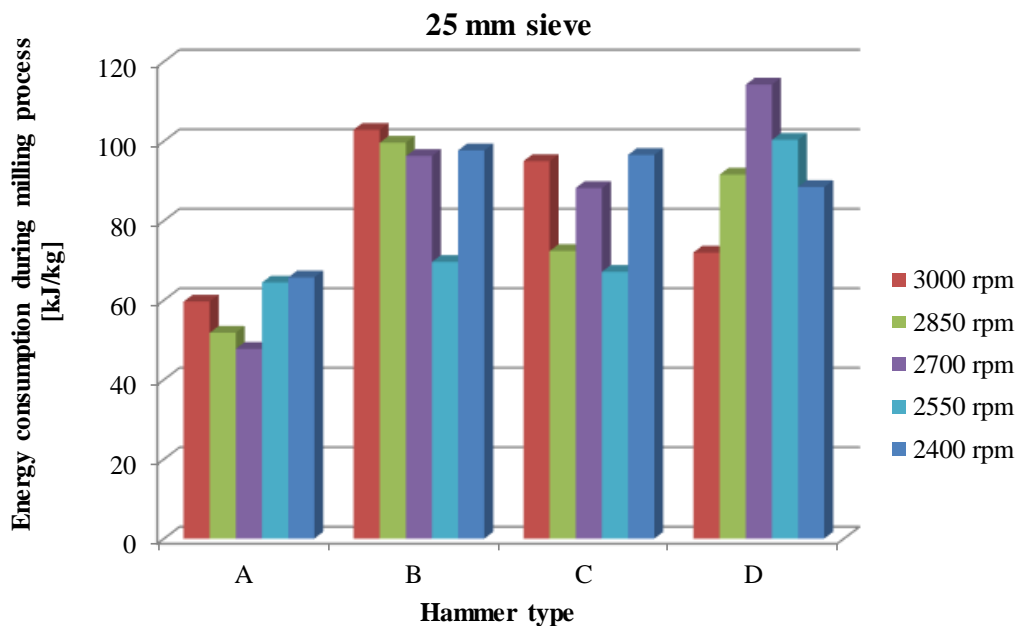

Figure 2: Energy consumption variation depending on the rotor speed

### 3. CONCLUSIONS

Considering all requirements for biomass processing and the requirements for the finite product it is necessary to analyze and make optimizations for each stage of the processing phases. Thus, taking into consideration this aspect, the grinding process of biomass it still needs many more experimental researches in order to improve each aspect that is involved in the process. In this paper the correlation between function parameters and the milling process were analyzed. The tested biomass consisted of *Miscanthus x giganteus* which has an interesting future in European countries as energy crops.

The experimental research done showed a correlation between all parties (hammer type, sieve orifices diameter, rotor's speed of revolution) which had an impact on the grinded material fractions and on the energy consumption during grinding process. It can be concluded that type A hammer shows material distribution percentage values between 39 – 76 % disregarding the speed of revolution used for testing and the highest value for correlation coefficient  $R^2=0.94$ . Also, for type A hammer all energy consumption values were lower than other types of hammers, between 35.71 and 64.42 kJ/kg, while the energy consumption recorded for type D hammer had values between 71.96 and 114.21 kJ/kg with two energy consumption values above 100 kJ/kg for a speed of revolution of 2550 and 2700 rpm.

## Acknowledgements

This work was funded by the Executive Agency for Higher Education, Research, Development and Innovation Funding, within the project entitled "Optimizing the composition of biomass mixtures for obtaining high quality pellets", ctr. 24 BG / 2016 (code PN-III-P2-2.1-BG-2016-0266).

## References

- [1] Cengiz Akdeniz, R., Haghghat Shishvan, S., *The requirement for new biomass pelletizing test device*, Agricultural Engineering, vol. 2 (154), pp. 25 – 34, 2015.
- [2] Whittaker, C., Shield, I., *Factors affecting wood, energy grass and straw pellet durability – a review*. Renewable and Sustainable Energy Reviews, vol. 71, 2017, pp. 1-11.
- [3] Karkania, V., Fanara, E., Zabaniotou, A., *Review of sustainable biomass pellets production – A study for agricultural residues pellets' market in Greece*, Renewable and Sustainable Energy Reviews, vol. 6(3), pp. 1426 – 1436, 2012.
- [4] Wang, S., Yuan, X., Li, C., Huang, Z., Leng, L., Zeng, G., Li, H., *Variation in the physical properties of wood pellets and emission of aldehyde/ketone under different storage conditions*, Fuel, vol. 183, pp. 314-321, 2016.
- [5] Kymalainen, M., Makela, M.R., Hilden, K., Kukkonen, J., *Fungal colonisation and moisture uptake of torrefied wood, charcoal, and thermally treated pellets during storage*, Eur J. Wood Wood Prod., vol. 73, pp. 709–717, 2015.
- [6] Jezerska, L., Zajonc, O., Vyletelek, J., Zegulka, J., *Mechanical material properties effect on pelletization*, Wood Research, vol. 61(2), pp. 307-320, 2016.
- [7] Castellano, J.M., Gomez, M., Fernandez, M., Esteban, L.S., Carrasco, J.E., *Study on the effects of raw materials composition and palletization conditions on the quality and properties of pellets obtained from different woody and non woody biomasses*, Fuel, vol. 139, pp. 629 – 636, 2015.
- [8] Garcia-Marver, A., Carpio, M., *Biomass palletization process*, Transactions on State of the Art in Science and Engineering, vol. 85, 2015, WIT Press.
- [9] Venturi, P., Gigler, J.K., Huisman W. *Economical and technical comparison between herbaceous (Miscanthus x giganteus) and woody energy crops (Salix viminalis)*, Renewable Energy, vol. 16 (1-4), 1999, pp. 1023-1026, 1999.
- [10] Noorfidza, Y.H., Muhammad, T.A., *Effect of particle size on mechanical properties of pellets made from biomass blends*, Procedia Engineering, vol. 148, pp. 93-99, 2016.
- [11] Chițoiu, M., Moiceanu, G., Voicu, Gh., Paraschiv, G., Vlăduț, V., Găgeanu I., *Aspects regarding biomass from energetic plants (energetic willow – salix viminalis) grinding process for pelletization*, Analele Universității din Craiova, seria Agricultură – Montanologie – Cadastru (Annals of the University of Craiova - Agriculture, Montanology, Cadastre Series, 2015.
- [12] Daraban (Oros), A.E., Jurcoane S.,Voicea I, Voicu Gh., *Miscanthus giganteus biomass for sustainable energy in small scale heating systems*, Agriculture and Agricultural Science Procedia, vol. 6, pp. 538 – 544, 2015.
- [13] Carte tehnică MC 22 Bonțida, <http://tractorul.ro/moara-cu-ciocane-mc-22.html>;

# STRUCTURAL AND CINEMATIC ANALYSIS OF THE ELEVATING MECHANISM OF A UTILITY VEHICLE'S SHUTTER

Victor MOISE, Luciana DUDICI, Alexandra ROTARU, Ștefan MOISE

## ABSTRACT

In the present paper the structural and kinematic analysis of the elevating mechanism of a utility vehicle's shutter is made. For each of the the mechanism module, kinematic computation procedures were developed, procedures that were used in a main computing program. The results were presented in tabular and diagrams forms, to give a clearer picture of the kinematic parameters of the mechanism elements

## INTRODUCTION

In order to facilitate utility machines loading with different products, the folding shutters [11] are used. These subassemblies are mounted in the rear of the machine and are hydraulically or pneumatically driven. Typically, these mechanisms have a variable structure, making them easy to use to achieve the intended purpose.

## METHODOLOGY

Figure 1 shows the kinematic schematic of the elevating mechanism of a utility vehicle. On the element 4 of the mechanism is rigidly mounted the platform on which the materials will be loaded.

To determine the kinematic parameters of the mechanism elements, the modular groups underlying the mechanism must be established, thus the structural analysis of the elevating mechanism must be made.

The mechanism has a variable structure, for the two operating phases (lifting the platform to the level of the body and ramping the platform in positive direction).

### 1. Structural analysis of the mechanism

Figure 1 shows the kinematic scheme of the lifting mechanism of the utility vehicles.

Taking into account the relative movements between the elements, it is noted that the mechanism has the following inferior joints:  $A(0R1)$ ,  $B_{12}(1R2)$ ,  $C(2T3)$ ,  $D(3R0)$ ,  $B_{14}(1R4)$ ,  $E(4R5)$ ,  $F(5T6)$  și  $G(6R0)$ .

The number of superior joints is zero.

The moving elements of the mechanism are:  $1(A, B_{12}, B_{14})$ ,  $2(B_{12}, C)$ ,  $3(C, D)$ ,  $4(B_{14}, E)$ ,  $5(E, F)$ ,  $6(F, G)$ .

Given the number of moving elements and the number of kinematic joints, the degree of mobility of the mechanism results, namely:  $M = 2$ , ie two independent parameters are required, so that the elements of the mechanism have unique determined movements.

Figure 2 shows the kinematic schematic of the lifting mechanism with the  $BT$  platform at the body level.

In order to establish the modular groups from which the mechanism is constituted, the structural and multipolar schemas presented in Figure 3 are drawn. From Figure 3, it is



observed that the mechanism consists of the base  $Z(0)$ , and the motor dyads  $RRTaR(1,2,3)$  and  $RRTaR(4,5,6)$ .

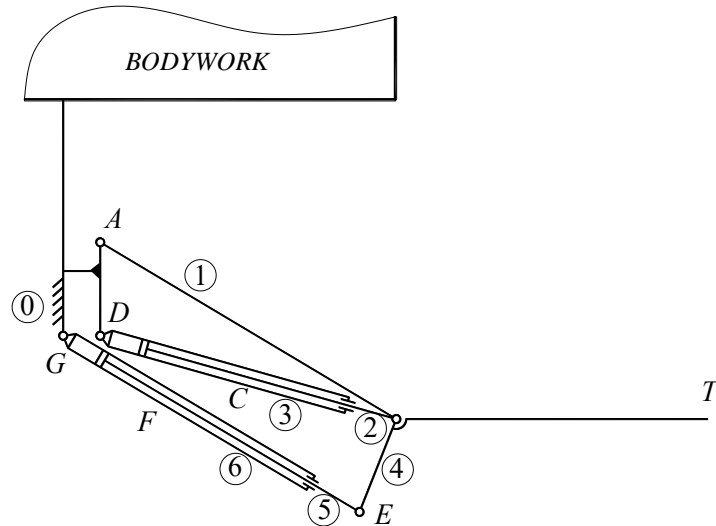

**Fig. 1.** The kinematic scheme of the lifting mechanism, with the *BT* platform at the bottom

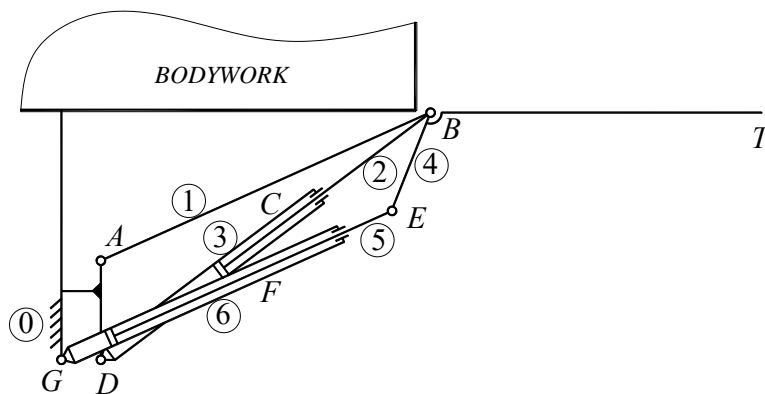

**Fig. 2.** The kinematic scheme of the lifting mechanism, with the *BT* platform at the body level

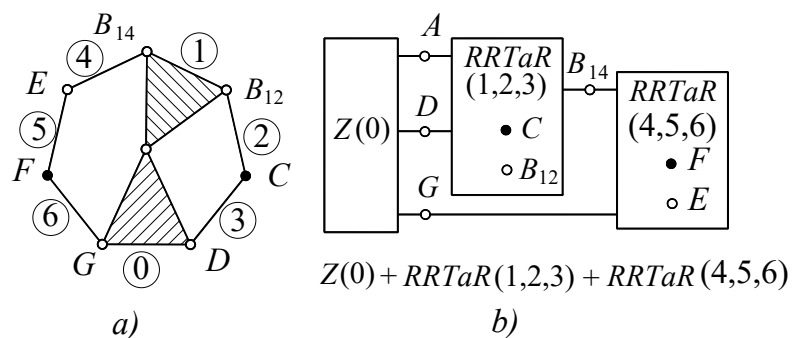
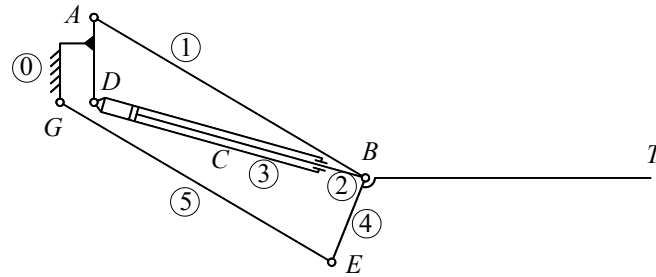

**Fig. 3.** a) the structural scheme of the mechanism; b) multipolar scheme and structural relationship

In the lifting process of the shutter, the mechanism has a variable structure. In this respect, to keep the shutter in a horizontal position, the hydraulic cylinder formed by elements 5 and 6 is locked to the size equal to the length  $AB$  (Fig3). Since the  $AG$  and  $BE$  distances are equal, the  $ABEG$  parallelogram is formed, making the *BT* platform horizontal. Figure 4 shows the

modular groups that make up the mechanism at this stage.

When the platform reached the machine's body level and the pallet was unloaded, the hydraulic cylinder 2-3 is locked and the point  $B$  becomes fixed (the  $ABD$  triangle is formed). In this case, the kinematic, structural and multipolar diagrams of the mechanism are shown in Figure 5.



**Fig. 3.** The kinematic scheme of the climbing mechanism, with cylinder 5-6 locked to length  $AB$

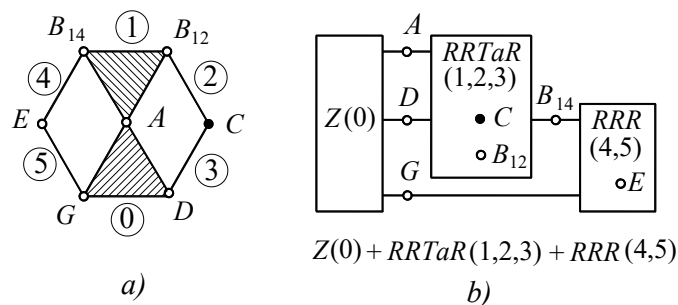

**Fig. 4.** a) the structural scheme of the mechanism; b) multipolar scheme; c) the structural relationship

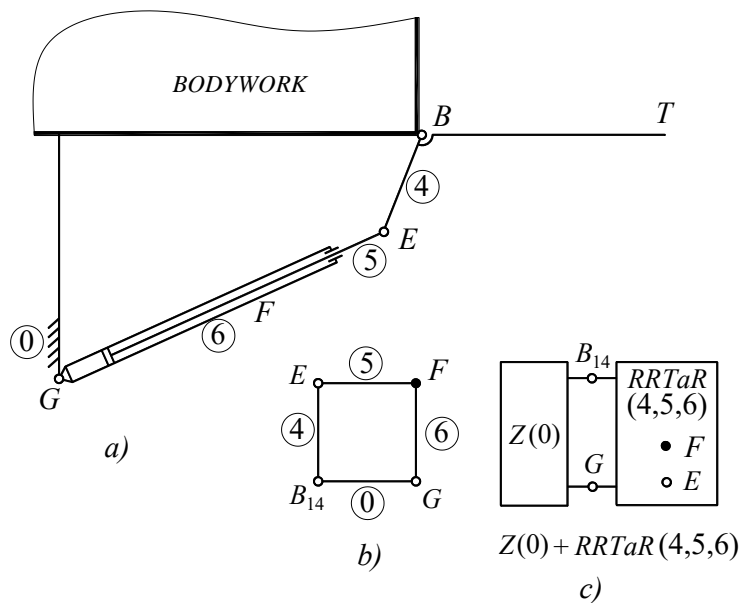

**Fig. 5.** The shutter lifting mechanism at the beginning of the ramping phase  
a) the kinematic scheme of the mechanism; b) structural scheme;  
c) multipolar scheme and structural relationship

## 2. The kinematic analysis of the mechanism

For the kinematic analysis of the mechanism are known several stages, namely:

a) composing the calculation program for the determination of the kinematic parameters of the mechanism's links;

- b) tabular presentation of the angular values made by the vectors  $\overline{AB}$ ,  $\overline{DB}$ ,  $\overline{BE}$ ,  $\overline{GB}$ , attached to the mechanism's links, with the positive sense of the AX axis;
- c) drawing the variation diagrams of the angular velocities and accelerations of the mechanism's links, according to the position of the mechanism.

The kinematic analysis of the mechanism consists in the determination of the position, velocity and acceleration parameters, adequate to all the links. For this, are called the **A2PVA.m**, **d1pva.m**, **A1R.m**, and **A1RALFA.m** functions, developed by the authors in MATLAB syntax.

In figures 6 and 7 are presented the kinematic schemes of the lifting and folding mechanism of the shutter, with the emphasis of the position parameters.

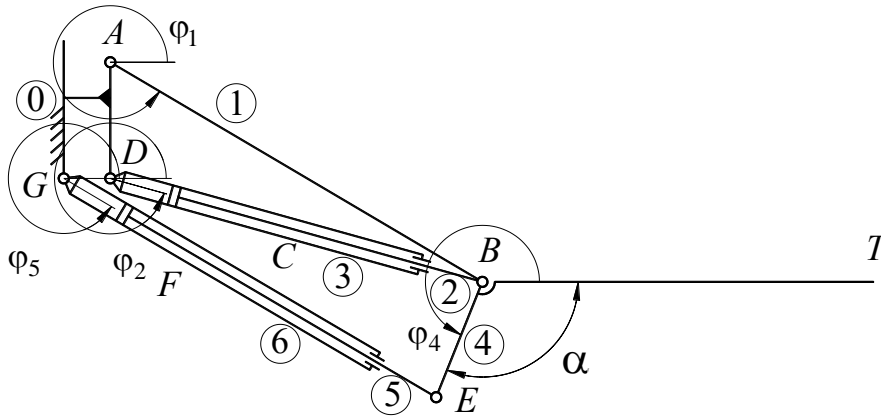

Fig. 6. Definition of the position kinematic parameters of the mechanism (lifting phase)

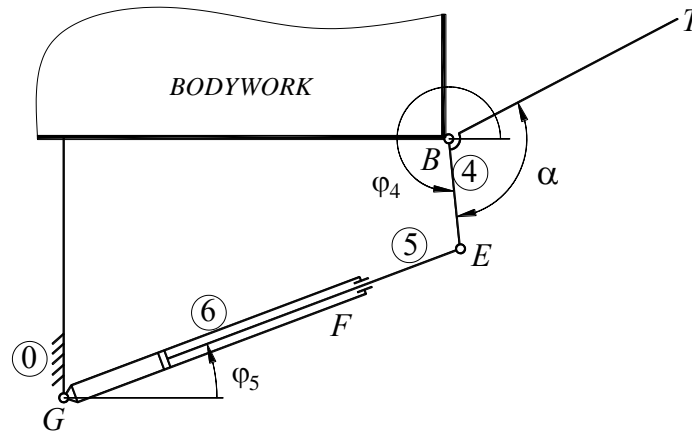

Fig. 7. Definition of the position kinematic parameters of the mechanism (folding phase)

### 3. Numerical example

For the analysis of the mechanism, are known:

- the kinematic scheme of the mechanism;
- the dimensions of the links and the positions of the joints adjacent to the base, as follows:  $AB = 0.700$  m,  $BE = 0.1581$  m,  $XA = 0.0$  m,  $YA = 0.0$  m,  $XD = 0$  m,  $YD = -0.150$  m,  $XG = -0.050$  m,  $YG = -0.150$  m,  $\alpha = 1.89$  rad.
- the initial position of the mechanism:  $s01 = BD_{init} = 0.600$  m,  $GE = AB = 0.700$  m (lifting phase of the platform),  $s02 = GE_{init} = 0.700$  m (folding phase of the platform);
- the relative velocities in the joints C and F:  $v_{23} = 0.100$  m/s,  $v_{45} = 0.100$  m/s;
- the relative accelerations in the joints C and F:  $a_{23} = 0.100$  m/s<sup>2</sup>,  $a_{45} = 0.100$  m/s<sup>2</sup>;
- the active strokes of the cylinders:  $curso1 = 0.200$  m,  $curso5 = 0.220$  m.

The calculations were made for 20 equidistant positions of the link 2 in relation to link 3

and 22 equidistant positions of the link **4** in relation to link **5**, starting from the initial position.

In table 1 are presented the position parameters of the mechanism's links, for the lifting phase of the platform, as well as for its folding phase.

Table 1

poz	fi1	fi2	fi4	fi5
0	5.4704	-0.6400	4.3906	5.4704
1	5.5509	-0.5484	4.3906	5.5509
2	5.6271	-0.4632	4.3906	5.6271
3	5.7003	-0.3828	4.3906	5.7003
4	5.7711	-0.3063	4.3906	5.7711
5	5.8403	-0.2329	4.3906	5.8403
6	5.9083	-0.1618	4.3906	5.9083
7	5.9755	-0.0927	4.3906	5.9755
8	6.0423	-0.0250	4.3906	6.0423
9	6.1090	0.0416	4.3906	6.1090
10	6.1758	0.1073	4.3906	6.1758
11	6.2432	0.1727	4.3906	6.2432
12	6.3113	0.2379	4.3906	6.3113
13	6.3805	0.3033	4.3906	6.3805
14	6.4511	0.3691	4.3906	6.4511
15	6.5236	0.4359	4.3906	6.5236
16	6.5984	0.5040	4.3906	6.5984
17	6.6761	0.5738	4.3906	6.6761
18	6.7574	0.6462	4.3906	6.7574
19	6.8435	0.7218	4.3906	6.8435
20	6.9356	0.8020	4.3906	6.9356
21	6.9356	0.8020	4.3906	6.9356
22	6.9356	0.8020	4.4942	6.9173
23	6.9356	0.8020	4.5849	6.9029
24	6.9356	0.8020	4.6677	6.8913
25	6.9356	0.8020	4.7448	6.8818
26	6.9356	0.8020	4.8179	6.8740
27	6.9356	0.8020	4.8881	6.8676
28	6.9356	0.8020	4.9560	6.8625
29	6.9356	0.8020	5.0222	6.8585
30	6.9356	0.8020	5.0872	6.8555
31	6.9356	0.8020	5.1513	6.8534
32	6.9356	0.8020	5.2149	6.8522
33	6.9356	0.8020	5.2782	6.8518
34	6.9356	0.8020	5.3415	6.8521
35	6.9356	0.8020	5.4050	6.8532
36	6.9356	0.8020	5.4690	6.8551
37	6.9356	0.8020	5.5338	6.8576
38	6.9356	0.8020	5.5996	6.8609
39	6.9356	0.8020	5.6667	6.8650
40	6.9356	0.8020	5.7355	6.8698
41	6.9356	0.8020	5.8064	6.8755
42	6.9356	0.8020	5.8800	6.8820
43	6.9356	0.8020	5.9568	6.8896

In figures 8 and 9 are presented the variation diagrams of the angular velocities and accelerations of the mechanism's links.

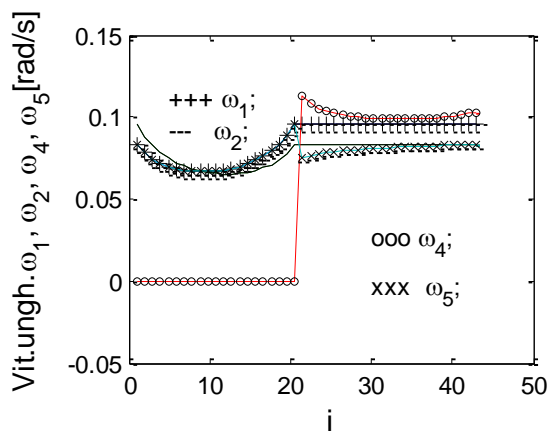

Fig. 8. The angular velocities charts of the mechanism's links

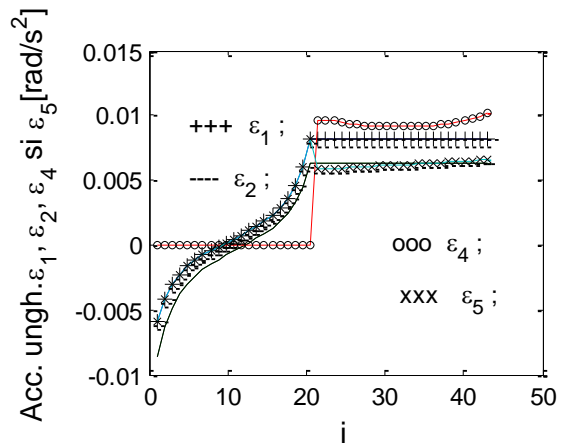

Fig. 9. The angular accelerations charts of the mechanism's links

## CONCLUSIONS

The kinematic analysis of the mechanism stands at the basis of kinetostatic computation. From the numerical data analysis, as well as the variation charts of the angular velocities and accelerations, the designer of such a mechanism can choose the most convenient solutions for a silent running of the mechanism. The values of these parameters can be used also in the case of kinetostatic computation of the mechanism, for the determination of the reaction forces from the kinematic joints, as well as for the driving forces in the hydraulic cylinders. Knowing the reaction forces allows the appropriate dimensioning of the kinematic links.

## BIBLIOGRAPHY

1. Artobolevski, I.I., *Theorie des mecanismes et des machines*, Mir, Moscou, 1977.
2. Demidovitch, B., Maron, I. - *Elements de calcul numeriques*, Mir, Moscou, 1976.
3. Dorn, W.S., Mc Cracken, D.D., *Numerical methods with programs in FORTRAN*, Technical Publishing House, Bucharest, 1976.
4. Duca, C., Buium, Fl., Păraoanu, G., *Mechanisms*, Gh. Asachi, Iași, 2003.
5. Moise, V., Maican, E., Moise, Șt. I., *Numerical methods in engineering*, Bren, Bucharest, 2003.
6. Moise, V., Simionescu, I., Ene, M., Neacșa, M., Tabără, I.A., *The applied mechanisms analysis*, Printech, Bucharest, 2007.
7. Pelecudi, Chr., *Precision of the mechanisms*, Academy R.S.R., Bucharest, 1975.
8. Pelecudi, Chr., Simionescu, I., Moise, V., Ene, M., *The design of the mechanisms*, The Politehnic Institute, Bucharest, 1981.
9. Pelecudi, Chr., Maroș, D., Merticaru, V., Pandrea, N., Simionescu, I., *Mechanisms*, Didactic and Pedagogical Publishing House, Bucharest, 1985.
10. Simionescu, I., Moise, V., *Mechanisms*, Technical Publishing House, Bucharest, 1999.
11. Voicu, Gh., *Equipment for communal household greening of settlements*, MatrixRom, Bucharest, 2007.

## INNOVATIVE MODEL OF VERTICAL DRYER FOR CEREAL SEEDS

PhD. Stud. Eng. Muscalu Adriana<sup>1,3)</sup>, PhD. Eng. Cârlescu Petru<sup>2)</sup>, PhD. Eng. Sorică Cristian<sup>1)</sup>,  
PhD. Eng. Arsenoia Vlad<sup>2)</sup>, PhD. Stud. Eng. Bîrsan Mariana<sup>1,3)</sup>

<sup>1)</sup>INMA Bucharest,

<sup>2)</sup>Department of Pedotechnics, University of Agricultural Sciences and Veterinary Medicine Iași,

<sup>3)</sup>University Politehnica Bucharest - Faculty of Biotechnical Systems Engineering

### ABSTRACT

Generally, after harvesting, healthy cereal seeds are subjected to conservation technologies, the most common being drying. This is a complex energy-intensive process of heat and mass transfer, the installations used having high energy consumption per kilogram of product, as well as a long drying time. In order to properly optimize the drying process, it is necessary to deeply know the phenomena related to the behavior of wet materials (seeds) in the drying installations. To this is added the highlighting of the decisive influence of their specific parameters on the decrease of moisture.

The paper presents a synthesis of mathematical modelling and simulations conducted in order to identify and determine a series of parameters based on which was dimensioned and designed the innovative Model of vertical dryer with heat recovery (MIUV-0).

### 1. INTRODUCTION

Reducing post-harvesting losses contributes to the increase of food safety and depends on threshing, cleaning, drying and depositing seeds. Drying represents removing moisture so that it allows seeds depositing for long periods, as well as satisfying the quality conditions the quality conditions imposed for seeds destined for consumptions or sowing, thus adequately responding to handling and processing [4].

Drying is the most intense energy process in the food industry. That is why, in the case of seed dryers, it is necessary to manage the thermal regime thoroughly by knowing their technical and functional parameters. Reducing energy consumption and ensuring high quality, with minimal increase in economic inputs, have become the targets for the continuous modernization of these machines [2,12]. Heating intensity and the energy consumption depend on the dimensions and on the initial temperature, the moisture of the bodies, the microstructural characteristics of porous materials, their anisotropy, the content and the aggregate state of the water inside them, the temperature and moisture values of the heating medium, etc. [11]

In general, the model is considered as a simplified (material or symbolic) representation of the objective reality (sometimes of an abstract theory) that is subordinated to the purpose of the research. The purpose of mathematical modeling is to build a tool (mathematical) that provides a comprehension of the action that raises interest and to make accurate predictions on its evolution. Always, the complexity of a model implies a balance between its simplicity and its accuracy of representation [1, 5, 6].

The innovative vertical dryer model with heat recovery (MIUV-0) was dimensioned and designed based on mathematical modeling and simulations conducted to identify and determine a series of specific parameters.

---

<sup>1</sup>6, Ion Ionescu de la Brad Bd., tel: 0726234242, e-mail:amuscalis@yahoo.com

## 2. METHODOLOGY

In order to estimate and track the evolution of temperature and moisture fields over time at any point of the product layer (cereal seeds) subjected to the drying process, a mathematical model was developed using CFD (Computational Fluid Dynamics) simulation and a laboratory dryer, which can be equipped with two drying boxes: rectangular (fig.1) or cylindrical (fig.2). The equipment allows the control and monitoring of the drying process parameters, which can be selected by the operator before or during the drying process [2, 3].

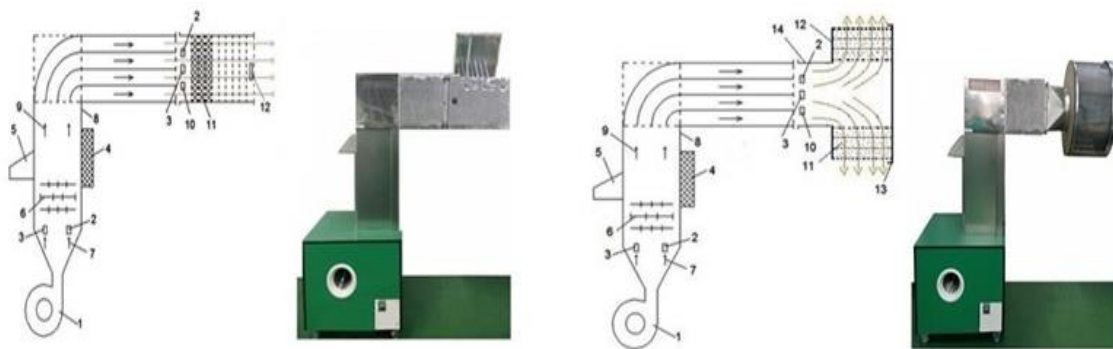

Figure 1: Diagram and general view of the laboratory drier [2]

With rectangular box

With cylindrical box

1 - ventilator; 2 – temperature sensor; 3 – moisture sensor; 4 – insulation layer; 5 – control panel; 6 – electrical resistance; 7 – cold air; 8 - body; 9 – hot air; 10 – speed sensor; 11 – drying cells.

12 – moisture sensor for the drying agent used.

12 – fixed cover; 13 – mobile cover; 14 – section changing.

The process of drying cereal seeds is carried out by convection, the heat being brought into the layers of material (considered porous), through the means of hot air (the drying agent). Once it enters the cereal mass, mass transfer (water) begins from the inside of the product towards its surface. The water moves both under the influence of capillary forces as well as due to the contraction of the product during dehydration, easily reaching the surface where the evaporation phenomenon occurs. Air is the transfer medium that takes up the vapors produced. Towards the end of the drying process, water transfer is slower due to the dry layer formed on the surface of the product [2, 3, 7, 8].

The mathematical model of the convective drying process is based on the theory of fluids dynamics, mass balance and energy. During the drying process, moisture decreases continuously, following complex variation laws [2].

Heat agent flow was simulated numerically for both types of dryers. For the cylindrical case, the current lines of thermal agent obtained had a laminar flow at the entrance to the box, and the thermal agent had a uniform distribution in the layers of seeds subjected to drying along the cylindrical sieve (fig. 3). This had favorable consequences in terms of the drying time, which was of a lower duration as well as on the uniformity of drying (fig.4). For cereal seeds is not recommended to use aggressive drying conditions, characterized by high temperatures and low moisture content of the drying agent, because they negatively influence the initial quality of the material, expressed mainly by the gluten content [2, 3]. The values of the temperature, the relative moisture of the drying agent and its speed (parameters of the drying regime) influence both the drying process and the quality of the material to be dried [2, 3, 7, 8].

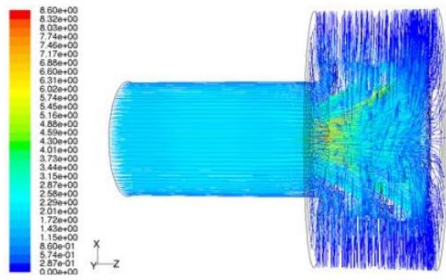

Figure 3: (Path lines) Flow of air field lines [2]

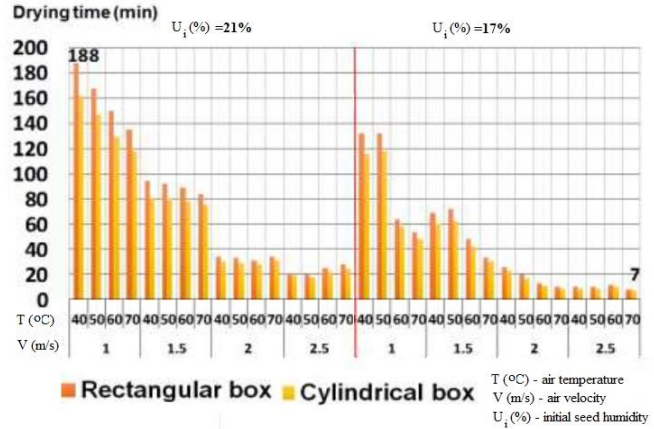

Figure 4: Variation of drying time for cereal seeds (wheat) [3]

By knowing the temperature profile in the grain seed layer is possible to optimize the air flow and temperature in the layers. For this purpose, the mathematical modeling of mass and heat transfer was achieved in a three-layered cereal seed dryer. Experimentally, a three-concentric layer cylindrical drier was designed and developed to study temperature and moisture distribution for improving qualitative indices of corn seed for preservation (Fig.5). The interior deflectors of the drier have the role of uniformizing the hot air, on the height of the layer [7].

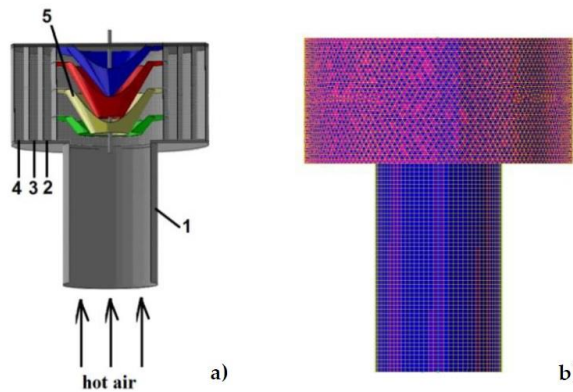

Figure 5: Geometry of driers and deflectors: a) section; b) hybrid mesh (1 thermal agent pipe (hot air), 2 layer I of seeds, 3 layer II, 4 layer III, 5 deflectors) [7]

The research method was developed by mathematical modeling of mass and heat transfer phenomena in corn seed layers based on a series of data obtained and verified by experimenting on the laboratory model. The equations governing mass and heat transfer are expressed in general terms, see Eq. (1). In order to model the phenomena that occur during the drying of corn, it is necessary to adapt them [7]. The partial differential equation of general form mathematically describing the drying phenomenon:

$$\frac{\partial(\rho_a \Phi)}{\partial t} + \nabla(\rho_a v \Phi) = \nabla(\Gamma \nabla \Phi) + S \Phi \quad (1)$$

$\Phi$  is the amount of interest that in this case is the energy or moisture content of the intergranular air,  $\rho_a$  is the air density,  $v$  is the superficial velocity or air load, as opposed to the average velocity of air flowing between corn seeds,  $\Gamma$  is the actual diffusion coefficient of  $\Phi$  through the layer of corn seeds,  $t$  is time,  $\Delta$  is del operator,  $S\Phi$  is a source term. Eq. (1) refers to a small differential corn region and this implies that the properties were averaged over a given final volume [7].



Thus, the standard CFD package has been modified to be used to simulate the transfer of moisture (mass) and heat occurring during the corn drying process. Characteristics that specifically apply to bulk dried corn have been adapted to operator defined functions (UDFs). These have been translated into "C" language and then inserted into the FLUENT software [7].

For CFD simulation, the geometry of the drying zone and its discretization in the form of a hybrid meshing having 938,000 elements (Fig.5b), using the GAMBIT software. Both for the experimental version and the CFD simulation were imposed the same initial conditions for seeds, and for seed initial moisture, the drying agent temperature, drying speed and drying time were considered the same values. After post-processing of CFD simulations, the main parameters of interest in the color scheme of the corn seed drying process for each calculation node were presented as temperature fields or by showing the flow of air through the lines of current depending on its speed and temperature. Subsequent processing was performed for the three layers of corn seeds following temperature and moisture distribution, see Fig. 6 [7].

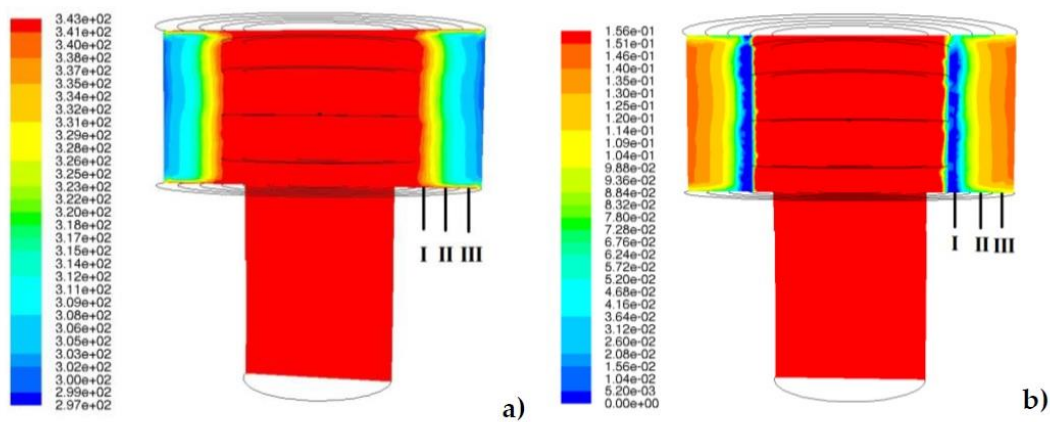

Figure 6: Vertical drier: a) temperature field K; b) absolute moisture field kg water vapors / kg dry product; I first layer; II second layer, III-third layer. ( $v = 2 \text{ m s}^{-1}$ ;  $T = 343 \text{ K} = 70 \text{ }^\circ \text{C}$ ) [7]

Following the mathematical modeling of mass and heat transfer and of the use of experimental data, CFD simulation resulted in an optimum thickness of 0.1 m corn layer in the dryer.

Based on mathematical modeling, the use of experimental data and CFD simulations, calculations were performed (energy balance, pneumatic transport, sizing, resistance, etc.) for a cereal seed dryer with heat recovery, modulated, of cylindrical shape, for which were considered: the maximum temperature of the drying agent  $70^\circ\text{C}$ ; atmospheric air temperature of  $20^\circ\text{C}$ ; relative air moisture 50%, etc. The hourly heat quantity required for the operation of the installation was evaluated, dimensioning the air current generating ventilator, the system for heating the medium, the pneumatic system for feeding the seed dryer and the supporting frame elements were evaluated. [9,10].

After evaluating the execution documentation, MIUV-0 was constructed. In order to solve the heat flow and heat transfer problems inside the vertical drier, the CFD simulation method was used. The complex construction geometry of the innovative vertical drying model with heat recovery for drying cereal seeds (Figure 7) was simplified for CFD simulation, so that the inner flow areas of the thermal agent and the transfer of heat that occurs during drying (Figure 8) can be visualized. The dimensions of the dryer used in the CFD simulation were identical with those of the built-in model, and the simplifications of the vertical drier geometry did not influence the physical phenomena occurring during the drying process

(height - 3 m, diameter - 1 m, layer thickness - 0.1 m, module height - 0.4 m;  $\Phi$  hot-air inlet - 0.2 m) [8].



Figure 7: Innovation vertical drier with heat recovery

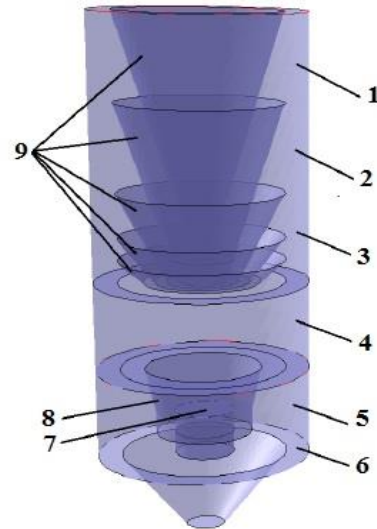

Figure 8: Vertical drier geometry for CFD simulation 1, 2, 3 drying sections; 4, 5 cooling sections; 6 grain seed layer; 7 warm air inlet for drying; 8 nozzle; 9 deflector cones [8]

CFD simulation allowed the temperature fields to be drawn in point of the vertical dryer (fig. 9), which would not be allowed by placing a large number of temperature transducers [8].

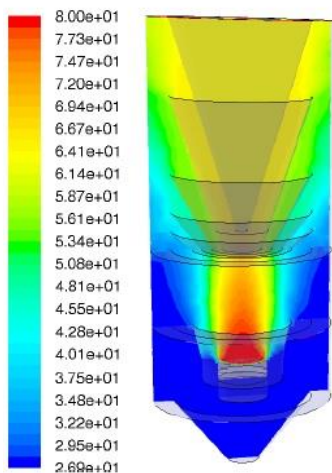

Figure 9: Temperature field on the vertical section ( $^{\circ}\text{C}$ )

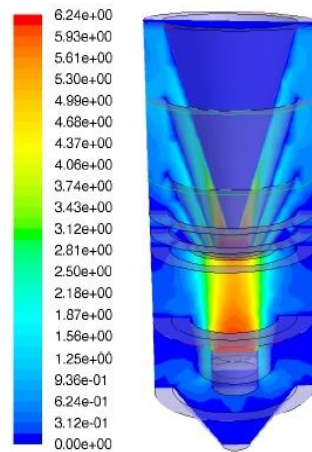

Figure 10: Velocity field on the vertical section ( $\text{m s}^{-1}$ ) [8]

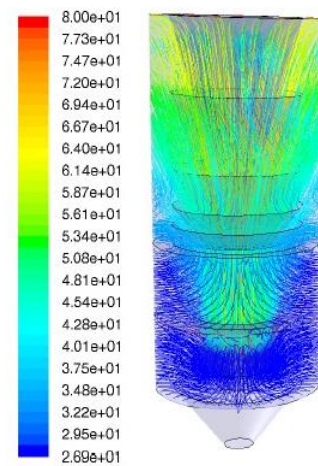

Figure 11: Path lines field on the vertical section [8]

By introducing the five cones inside the drier, air velocity distribution in the three drying zones became uniform, and the velocity vector was directed from inside the drier to the outside (fig. 10). In the two cooling regions at the bottom of the drier, the insertion of the injector made it possible to orient the velocity vector from the outside to the inside by absorbing the cold air from the atmosphere to cool the cereal layer. The air velocity at the entrance of the dryer was  $6 \text{ m s}^{-1}$ , and in the cereal layer was  $1 \dots 2 \text{ m s}^{-1}$  [8].

The distribution of current lines from the exterior and the thermal agent inside the vertical dryer (fig. 11) shows the role of deflector cones and of injector nozzle formed inside the drier. By the construction formation of the injector and by placing it in the lower part of the dryer, a local pressure drop occurs, leading to the absorption of air from the atmosphere through the two lower cooling regions of the dryer, causing cooling of the dried cereals. Thus, part of the heat they accumulated through the drying process was recovered and reintroduced into the dryer's general circuit. The temperature obtained by CFD simulation had an error of  $\pm 5\%$  compared to the experimental determinations, representing an acceptable level in the heat transfer domain.

## CONCLUSIONS

Following the CFD simulations on the pilot installation, the calculations and the design, a modular Innovative Vertical Dryer Model with heat recovery was developed, equipped with heating / cooling agent equalizing devices. Modulated construction offers the possibility of assembly and adequate adjustments inside the dryer, at the level of devices for temperature and velocity parameters uniformity. The development of the machine contributes to the development of research in the field of additional devices for guiding airflow towards the cereals layers, because vertical driers that are currently available on the market, are not provided with such endowments.

## ACKNOWLEDGEMENTS

This work was supported by a grant of the Romanian National Authority for Scientific Research and Innovation, CNCS/CCCDI – UEFISCDI, project number PN-III-P2-2.1-PED-2016-1357, within PNCDI III, contract no.18PED/2017.

## References

- [1] Andrei N., *Essay on Fundamentals of Informatics*, Yes Pub. House, Bucharest, 2006.
- [2] Arsenoaia V.N, Cârlescu P., Corduneanu O., Diaconu A., Țenu I. *CFD Simulation of the Hot Air Flow Used For Cereal Seed Drying*, ISSN 1454 – 8003, Proceedings International Conference on Hydraulics and Pneumatics – HERVEX, pg. 298-302, Baile Govora, Romania November 9-11, 2016.
- [3] Arsenoaia V., Carlescu P., Rosca R., Tenu I., *Studies Regarding the Technological Effect of a New Drying Method on the Quality of Wheat Seeds*, International Symposium ISB-INMA TEH – AGRICULTURAL AND MECHANICAL ENGINEERING, Bucharest, ISSN 2344-4126, pg. 303-308, 26-28 October 2017;
- [4] Bala B. K. *Drying and Storage of Cereal Grains*, Print ISBN:9781119124238, Online ISBN:9781119124207 DOI:10.1002/9781119124207, John Wiley & Sons, Ltd. 2016.
- [5] Bistriceanu E., Stănășilă O. *Mathematics and Reality*, Matrix Rom Pub. House, Bucharest, 2009.
- [6] Cârlescu P. M., *Modelling and Numerical Simulation of Industrial Physic Processes* Performantica Pub. House, Iași, 2005.
- [7] Cârlescu P.M. , Arsenoaia V. N, Tenu I., Muscalu A., Birsan M. *Researches of Mass and Heat Transfer of an Innovative Vertical Dryer*, Proceeding of the 46-th International Symposium Actual Task on Agricultural Engineering, Opatija, Croatia, pg. 407-417, 27-th February - 1-st March 2018.
- [8] Cârlescu P.M., Arsenoaia V. N, Tenu I., Muscalu A., Vladut V. *CFD Simulation of an Innovative Vertical Dryer for Agricultural Seeds Dryer* Proceeding of the 46-th International Symposium Actual Task on Agricultural Engineering, Opatija, Croatia, pg. 419-427, 27-th February - 1-st March 2018.
- [9] Cernăianu C. *Considerations on optimizing the heat balance of the fluid bed seed drying plant*. Termotehnica (AGIR), pg.41-46, no. 1-2/2005;
- [10] Costin I. *Miller's Book*, Technical Pub. House, Bucharest 1988;
- [11] Deliiski N. *Transient Heat Conduction in Capillary Porous Bodies, Convection and Conduction Heat Transfer*, Dr. Amimul Ahsan (Ed.), ISBN: 978-953-307-582-2, October 2011;
- [12] Doymaz, I., İsmail, O., *Drying Characteristics of Sweet Cherry*. Food and Bioproducts Processing, 89(1), pg. 31-38, 2011.

# CONSIDERATIONS ON THE CONSTRUCTION AND OPERATION OF A DEVICE FOR SOIL MODELLING IN INTERRUPTED FURROWS FOR WEEDING CROPS

Oprescu Marius Remus<sup>1)</sup>, Biris Stefan Sorin<sup>2)</sup>, Voicea Iulian<sup>1)</sup>, Cujbescu Dan<sup>1)</sup>, Persu Cătălin<sup>1)</sup>, Găgeanu Iuliana<sup>1)</sup>, Vlăduț Valentin<sup>1)</sup>, Dumitru Iulian<sup>1)</sup>, Cristea Mario<sup>3)</sup>

<sup>1)</sup> INMA – Bucharest / Romania, <sup>2)</sup> University Politehnica of Bucharest / Romania,

<sup>3)</sup> SC Cantarprood SRL

E-mail: *oprescu.remusmarius@gmail.com*

## ABSTRACT

Lately, there is a decrease in the arable land, while the population grows, so it is necessary to increase the agricultural production per unit of surface in order to meet the food needs. Water resources are reduced; therefore, it is important to promote techniques and technologies that efficiently use water from various sources, with low energy consumption. In the case of weeding crops, directing water along the plant row or uniform storage is achieved with continuous or interrupted (compartmentalized) furrows. The present paper aims to analyse the construction and operation of a device for soil modeling in interrupted furrows for weeding crops, simultaneously on 5 intervals - DMBC5-0.

## INTRODUCTION

For soil supply with additional water to those naturally received by precipitation, quantities established according to the pedoclimatic conditions and the requirements of the plants, it is necessary to establish additional works in the respective technologies. Determination of the extra amount of water should be made in such a way that the soil layer in which the roots develop maintains optimum humidity. Due to the fact that the arable area is decreasing while the population is growing, the increase in agricultural production per surface unit remains the main solution to meet the growing and better quality demands of food.

The achievement of large agricultural output is influenced by several factors (mechanization, fertilization, weed control, pests control, soil biological potential, seed quality), each with its importance, but the lack of soil water over periods overlapping the critical phases in plant development, diminishes the harvest, even reaching its total compromise as a result of drought.

In Romania, the area with economic irrigable potential is estimated at 3 million hectares, of which 1.5 million ha with high economic efficiency. In this context, irrigation will become the most important water consumer in agriculture and one of the main consumers nationwide, requiring on average 35-45% of the country exploitable water resources. Water resources in Romania are low, with a value of about 1660 m<sup>3</sup>/inhabitant, while in other European countries they are 2.5 times bigger and therefore it is important to promote techniques and technologies that efficiently capitalize water from various sources, with low energy consumption. Soil water and its circulation are of interest, as approximately 41% of our country's arable land is affected, during certain periods of the year, by excessive humidity in approximately half of the arable area, while during the same year longer or shorter periods of drought are recorded; then it is necessary to apply watering with variable norms, and the soil erosion phenomena appear on 35% of the total agricultural area.

---

<sup>1</sup> 6, Ion Ionescu de la Brad Blvd., tel: 0766580791, e-mail: *oprescu.remusmarius@gmail.com*

Water resources in Romania are modest compared to other countries in Europe (11th place for local resources and 21st place for the ones formed on its territory). [3] Gravitation is the oldest form of irrigation. The surface draining consists in the fact that water is distributed on the ground by free flowing on the furrows or strips; during the draining, water also infiltrates in the soil. The method has expanded to weeding crops sown in strips or at bigger distances between rows with a minimum slope required for water free draining on the furrow.

[4] Opening the interrupted furrows is necessary in the following situations:

- ✓ on lands set up for water spraying by fixed or mobile installations and which have bumps or slopes that cause water to drain and to form puddles in micro depressions;
- ✓ on lands with small slopes, not adapted for irrigation and where the precipitation water drains rapidly downstream, not being used by the plant and producing the erosion phenomenon.

Farmers are interested in soil moisture conservation and have sought methods of collecting and storing a maximum amount of water in the soil to meet crop needs. They admit that crop yields have been limited over several years because of droughts in almost all areas of the country. Precipitation falls randomly and the amount of water is not in line with plant needs. Most precipitations in the vegetation season fall during high-intensity rainfalls. Only a small part of this rain water infiltrates the soil, the rest causes excessive draining and erosion. One way to accumulate water from rainfall is through crop practices, consisting in the execution of compartmentalized furrows [8]

Compartmentalized furrow is the result of a mechanical soil work that leaves furrows interrupted by soil mounds at adjustable intervals to form small water accumulation basins. During rainfall, excess water is accumulated in these basins so that it can be slowly absorbed by the soil, eliminating the possibility of draining outside the cultivated area. This is especially important because, during rainfalls, the precipitation intensity often exceeds the rate of water infiltration in the soil. [8] Experience has shown that wind erosion can also be reduced. On sloping land, by practicing the interrupted furrows, prevention and reduction of puddle forming also occurs in the low areas of the cultivated land.

## **METHODOLOGY**

Watering is both an important technological sequence in the crop plant agrotechnology, as well as the most important technical means of eliminating the water deficit in the soil, constituting the infrastructure of sustainable development. Technologies to combat the effects of climate change have evolved to reduce the water consumption of plants (dripping, micro-spraying), to obtain high water capitalisation by reducing losses and associating with other works (fertilization, chemical weeding, etc.) and to use other sources of water (waste water from animals or rural, urban and industrial environment). Furrows used in agriculture are of great importance for agricultural production and are a major component of the agricultural ecosystem [5],[6],[7],[8]. It is estimated an increase in agricultural production per hectare by 20% in agricultural crops with interrupted furrows. This is explained by the infiltration of a larger amount of water at the plant roots and by the reduction of the soil erosion phenomenon [3].

In the case of continuous or interrupted furrows it is intended to obtain sections of the furrow as large as necessary to carry and accumulate as much water as possible. In soils with poor drainage, growers prefer to use alternative furrows.



Figure.1. Continuous and interrupted furrows after the rain [4]



Figure.2 Alternative furrows[1]

The furrow opening work is known as ridge plowing (soil modeling) and it was initially carried out with the help of some ridge ploughs trailed by animals. This is done with a machine that works in aggregate with a tractor; on the machine is mounted the equipment for continuous furrows or a specialized equipment for making interrupted furrows. The machine equipped for the execution of continuous furrows is made up of ridge ploughs which make the triangular section of the furrow and modifiers that make the parabolic section and the finishing of the furrow, and the machine equipped for the execution of the interrupted furrows is made up of the same ridge ploughs, the rotors with blades and a mechanism for controlling the rotors for interrupting the furrows and the execution of some small dikes (soil heaps), both equipment being mounted on a frame with supporting wheels. The number of working stations is selected based on the sowing pattern, the spacing between the sections and the processed interval between the rows (on each interval or at two intervals). The most commonly used sowing pattern for weeding crops is 6 or 8 rows and the maximum number of processed intervals is 5 and 7 respectively, which must coincide with the number of working stations.

The device for soil modeling in interrupted furrows for weeding crops, simultaneously on 5 intervals, DMBC5-0 (Fig. 3) is intended for soil modeling in interrupted furrows for weeding crops sown at 70-80 cm for the accumulation of precipitation water and the achievement of water uniform distribution of on the surface of the soil, on lands with a slope of up to 5%, on soils ploughed at least 250 mm, with light, medium or heavy texture, at a humidity at which the soil does not stick to the active part.



Figure 3. Device for soil modeling in interrupted furrows for weeding crops, simultaneously on 5 intervals, DMBC5-0

The device for soil modeling in interrupted furrows for weeding crops, simultaneously on 5 intervals, DMBC5-0 consists of the following main parts:

- ✓ frame with the triangle for coupling to the tractor;
- ✓ wheels for adjusting and limiting the device working depth;
- ✓ knives for soil loosening before the ridge ploughs;
- ✓ ridge ploughs;
- ✓ equipment for furrows interruption.

The frame of the device is made of two square cross-section pipes, parallel to each other, welded to the ends by welded beams. The triangle for three-point coupling to the tractor (ISO II) is welded to the front of the frame. On the sides of the frame are mounted some removable rods that will increase the working width of the device from 3600 mm to 5200 mm. The frame clearance will be adjusted according to the height of the plants by means of the loosening knives, respectively of the ridge ploughs, holders.

The wheels for adjusting and limiting the working depth are of metallic or rubber band type, currently used in soil working machines. The wheels have a diameter of 500 mm and are mounted on the equipment frame, on the sides. The working depth of the active parts is continuously adjusted by lifting or lowering the wheels by means of a spindle screw actuated by a crank. The lateral demountable bars and support wheels are positioned on the frame, respectively on the interval between the plant rows. A working station consists of a loosening knife, a ridge plough and a pallet rotor with control equipment.



Figure 4. Working section



Figure 5. Loosening knife



Figure 6. Ridge plough

The 3, 4 or 5 loosening knives are fastened by means of special clamps and cases of the square pipe. The knives are chisel type and can penetrate into the soil at a depth of maximum 20 cm. The cases allow the vertical slide of knife holders; they can be adjusted to the plant height. Fixing the knife in a certain position is done by turning a screw. The 3, 4 or 5 ridge ploughs have the holders fastened by means of clamps and cases on the second square pipe, behind the loosening knives and are mounted at variable distances on the device frame, according to the furrow pattern. The ridge plough consists of a removable knife, a ridge-carrying support, two breasts and a vertical support. The breasts can be mobile or fixed, making a variable or fixed opening. The ridge-carrying support will be fastened by means of two screws to the ridge plough support, which adjusts the angle of ridge plough penetration into the soil and constitutes the overload safety device. The ridge ploughs are made of properly treated manganese sheet. The angle of ridge plough penetration into the soil can be adjusted by rotating the ridge-carrying support about the vertical support. The vertical support, which is a rectangular cross-section pipe, is fastened by means of special two clamps and one case to the second rear pipe of the frame. Adjusting the vertical support in the fastening case allows the frame to pass over the plants in the weeding crops. When the agricultural machine passes, the plants must not exceed 60 cm in height in order not to

damage them. The active parts (the loosening knives and the tip of the ridge plough) are hardened and the edges are sharpened during the machine operation.

The equipment for furrow interruption, mounted on the rear pipe of the frame, consists of a camshaft, mechanisms to transmit the movement to the bolts blocking the blades 3, 4 or 5 blade rotors. The rotation of the right side wheel is transmitted by a chain transmission to an axle positioned parallel to the second square pipe (rear), axle that will have some cams positioned next to each working section.



Figure 7. Equipment for furrow interruption



Figure 8. Chain transmission

During the rotation movement, the camshaft will drive the lever/cable mechanism from each section, namely it unblocks the blocking bolt and by rotating the blade, the furrow heap will be made; by cyclical unblocking of the rotor according to the distance travelled by the device, partition heaps will be made at predetermined distances. The rotors will have three or four blades of trapezoidal shape. The rotors are mounted behind the ridge ploughs in a frame allowing vertical rotation and oscillation, being pressed against the bottom of the furrow by two springs mounted on the sides or by springs pressing vertically according to the attached documentation. While the rotation of one blade is blocked by a bolt, it will scrape the bottom and the side walls of the furrow, gathering a quantity of soil in front of it.

When the eccentric cam drives the lever mechanism, the bolt retracts, releases the rotor with the blades, which rotates one step (the distance between two blades), leaving a soil heap on the furrow, with a base width between 20 and 40 cm and the height equal to the depth of the furrow. While the blade rotor rotates by  $90^\circ$ , the bolt, released by the cam action, returns to the previous position, blocking the next rotor blade and then the cycle repeats. The device provides the modeling of the watering furrows compartmentalized on the intervals between the plant rows in two ways:

- ✓ alternatively, an interval with furrow and an interval without furrow or,
- ✓ consecutively, on each interval depending on the sowing pattern, soil type and the plant root area.

## CONCLUSIONS

The basins bordered by small dikes are designed to temporarily store rainwater (which would otherwise flow out of the cultivated area), which will infiltrate the soil, thereby increasing the water reserve in the soil and the efficiency of water recovery from precipitation.

The small dikes are made with an agricultural machine, equipped with several working sections, each section, grinds the soil with a chisel, scraps it with a hoe and forms from place



to place at predetermined distances soil dikes to collect water from precipitation. The machine is used on a low slope land in arid and semi-arid areas where crops lack water.

The practice has been widely adopted due to new watering technologies, as well as to the equipping of agricultural machinery with devices for making interrupted furrows. They usually make, in the furrow, small dikes at intervals of 1-2m. Some growers do not open furrows on the range trailed by tractor wheels during chemical weeding or other agricultural works.

## ACKNOWLEDGEMENT

This work was funded by the Ministry of Research and Innovation, within the project entitled PN 18 30 01 01: "Experimental research on the aerial mapping of agricultural crops corresponding to the Agriculture 4.0 concept", ctr. 18N/16.03.2018

## References

- [1]. Edwin C. and Alexander U.U. (1986), *Texas Agricultural Extension Service*; \*\* Texas Agricultural Experiment Station, 1986.
- [2]. AQUAPROIECT SA., *Device for soil modeling in interrupted furrows in two constructive solutions*. Financing contract no. 4639/2017.
- [3]. Biolan I., Serbu I., Mardare F., Biolan C., *Modern irrigation techniques for agricultural crops*, AGIR publisher, 2015;
- [4]. Biolan I., Serbu I., Tusa G.C., Mardare F., *Agricultural crops irrigation, technologies*, AGI publisher, 2016.
- [5]. Guo X.N., Hu T.S., Tan G.M., *Farmland drainage standard based on multi-attribute analysis*, Transactions of the Chinese Society of Agricultural Engineering, 25, pp. 64-70, 2009.
- [6]. He X.C., Shao D.G., Liu W.Y., *Research progress and prospect of resource utilization of farmland drainage*, Transactions of the Chinese Society of Agricultural Engineering, vol. 22 pp.176-179, 2006.
- [7]. Li Y.H., *A review of environmental effect and ecosystem function of farmland drainage ditch*. Heilongjiang Science and Technology Information, 2016;
- [8]. Song C.J., Li Q., Wang Y., *Research overview of ecosystem effect of farmland drainage ditch*, Modern Agricultural Sciences and Technology vol. 2 pp. 201-203, 2014.

# METHODS OF ARRANGING THE KNIVES ON THE CHOPPING DRUM FROM THE FORAGE HARVESTER

Ph.D. Stud. Eng. Popa R.<sup>1</sup>, Ph.D. Stud. Eng. Popa V., Prof. Ph.D. Eng. Biriş S.Şt.

## ABSTRACT

In the technological process of the forage harvester, the most important working tool is the chopper, which performs the fragmentation of the feed to the required size and throws it to the exhaust system of the combine. In order to achieve the best performance a very important role is represented by the arrangement of the knives on the chopping drum. The paper presents different methods of arrangement of knives on the chopping drum, as well as the advantages of these arrangements.

## 1. INTRODUCTION

The knife drum and counter knife are used for chopping at most forage harvesters. [1] The drum chopper consists of: the drum with the knives, the casing of the drum and the counter knife. The drum is made up of the drum shaft, the discs (knife holders) and the knives. Knives can be straight or curved. [1]

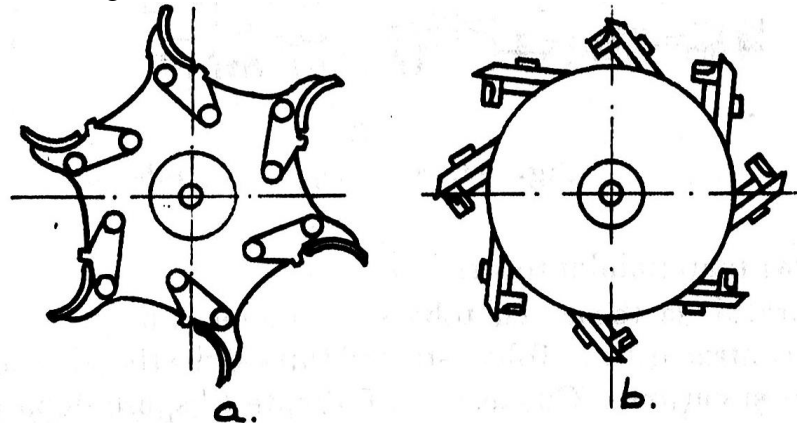

Figure 1: Chopping drums [1]

The increasing demands in terms of the performance of chopping drums, the quality of chopping, and the reduction of losses were reasons that led to numerous research in the field of chopping machinery

## 2. METHODS OF KNIFE ARRANGEMENT

An option is represented by a cutter comprising a support and a plurality of combined knife and fan members wherein the members extend substantially the full length of the cutter and each having a projection extending there ahead and serving as a cutting portion. The cutting portions of each knife are displaced axially relative to each other. [2]

The effective number of knives is variable to a degree beyond that heretofore possible, while maintaining proper balance of the cutter head. The non-cutting portions of the knives serve as rotors for pushing the cut pieces of plants. [2]

---

<sup>1</sup>Bucharest, Romania, 0744232253, radu12m@yahoo.com

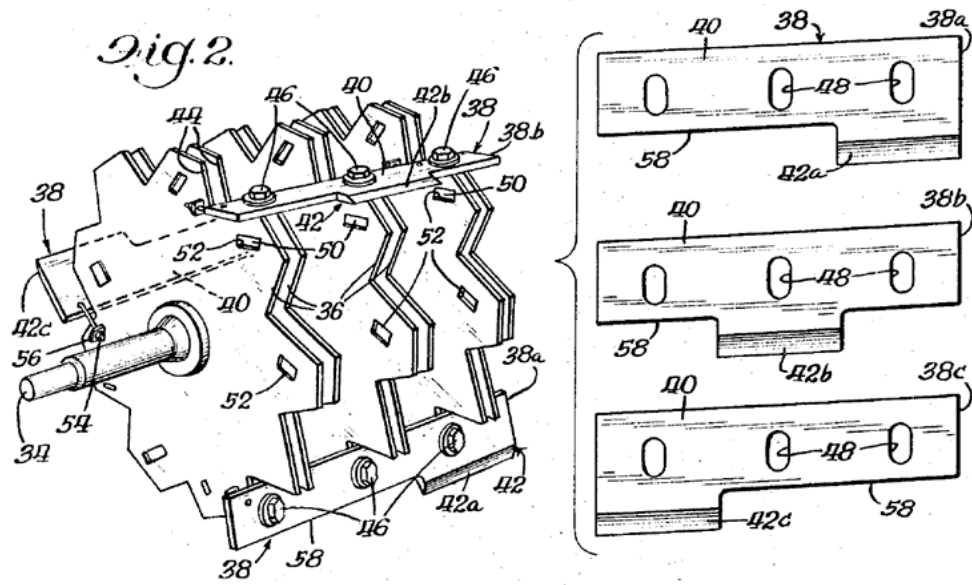
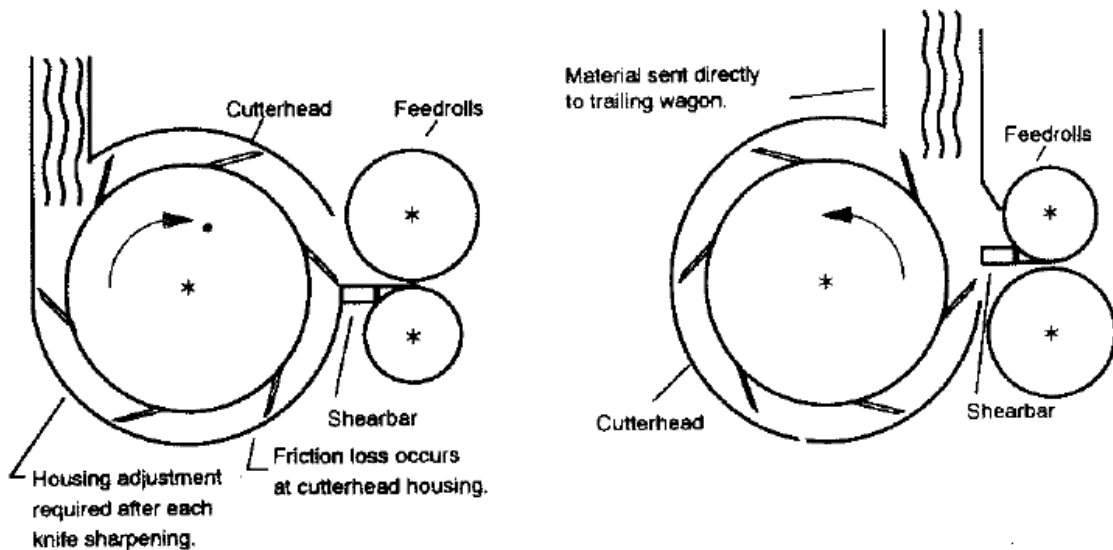

Figure 2: Cutter head with offset cutting edges [2]

An alternative forage harvester was developed to reduce machine energy requirements by utilizing an upward cutting cut-and-throw configuration. The cutterhead was inverted from its conventional orientation so that the knives entered the mat of uncut material from below. This upward cutting concept allowed the chopped material to be thrown directly out of the cutterhead without the subsequent friction loss of sliding the chopped material one-half revolution around the cutterhead housing as typical with conventional cut-and-throw configurations. [3]



Conventional downward cutting cutterhead      Experimental upward cutting cutterhead

Figure 3: Schematic of different cutting configurations for cut and throw forage harvesters [3]

Experiments were performed to compare the upward cutting cut-and-throw machine to the cut-and-blow machine and a conventional cut-and-throw machine. The upward cutting cut-and-throw reduced the energy requirements by 31 and 37% compared to the conventional cut-and-throw and cut and-blow machines, respectively. [3]

Table 1: Energy requirements of upward cutting cut-and-throw, conventional cut-and-throw, and conventional cut-and-blow harvesters [3]

Machine Configuration	Moisture Content (%)	Feed Rate (t/ h)	Specific Energy (kWh /t)	Mean Length of Cut (mm)
Cut-and-blow	63.4	13.5	1.98	10.9
Conventional cut-and-throw	64.0	13.8	1.80	11.4
Upward cutting cut-and-throw	64.0	13.3	1.25	12

The upward cutting cut-and- throw reduced overall machine energy requirements because the blower was eliminated and friction loss in the cutterhead housing was virtually eliminated.

Nowadays, most manufacturers use V-shaped knife configuration to ensure a consistent chopping of the crop. Most choppers also feature automatic knife sharpening systems.



Figure 4: Class V-Max chopping drum [4]

V-shaped curved knife configuration advantages:

- Optimal cutting precision ;
- Extremely smooth, energy-saving action;
- High strength due to the way the curved blades are mounted, the cutting forces are taken directly by the star-shaped cylinder. [4]



Figure 5: Fendt chopping drum [5]

Another option used by current manufacturers is the arrangement of knives in cascade.

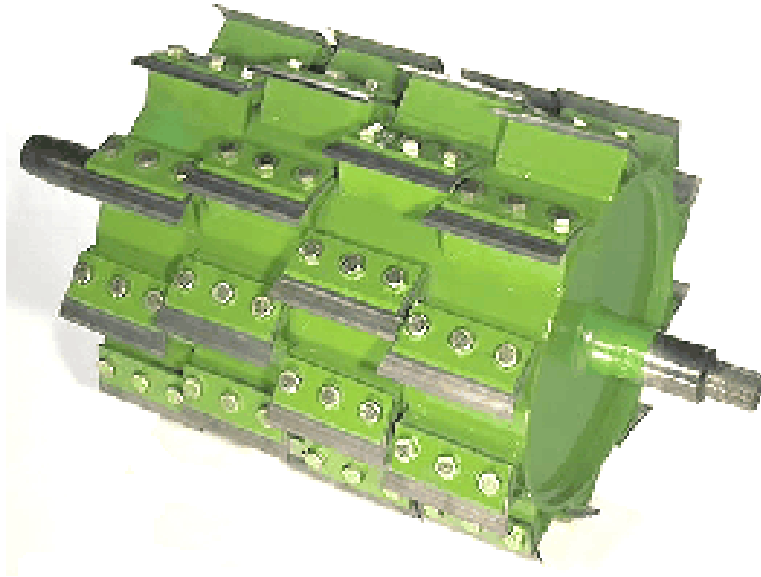

Figure 6: John Deere 800 Series chopping drum [6]

The knives are mounted on straight supports to provide a vertical cut, directly through the material, which results in a uniform flow of material across the entire width of the counter knife, the grain breaker and the blower housing. [6]

### 3. CONCLUSIONS

Nowadays, most manufacturers use V-shaped knife configuration to ensure a consistent chopping of the crop. Also systems with cascade knives are also used.

To reduce the energy demands of choppers, the knives can be mounted so as to enter the crop from the below.

In order to maintain the proper balance of the chopper, the cutting portions of each knife may be displaced axially from one another.

### References

- [1] Neculăiasa V., *Procese de lucru și mașini agricole de recoltat*, Editura A 92 Iași, 1995;
- [2] M. L. HOCH, *Forage harvester having cutter head with offset cutting edges*, 1968;
- [3] K. J. Shinnars, *An upward cutting cut-and-throw forage harvester to reduce machine energy requirement*, American Society of Agricultural Engineers, 1991;
- [4] <http://www.claasofamerica.com/product/forage-harvesters/jaguar980-930>;
- [5] <http://www.fendt.com/int/7712.asp>.
- [6] [https://www.deere.com/en\\_US/products/equipment/hay\\_and\\_forage\\_equipment/forage\\_harvesters/8000\\_series\\_self\\_propelled\\_forage\\_harvesters/8000\\_series\\_spfh.page](https://www.deere.com/en_US/products/equipment/hay_and_forage_equipment/forage_harvesters/8000_series_self_propelled_forage_harvesters/8000_series_spfh.page);

# SEPARATION BY SIZE AND EXTRACTION OF VALUABLE COMPOUNDS FROM MEDICINAL PLANTS OF NETTLE

Pruteanu A.<sup>1)</sup>, David L.<sup>2)</sup>, Ferdeş M.<sup>2)</sup>, Voicea I.<sup>1)</sup>, Niţu M.<sup>1)</sup>, Zăbavă B. Şt.<sup>2)</sup>

<sup>1)</sup>INMA Bucharest; <sup>2)</sup>UPB Bucharest

E-mail: [pruteanu\\_augustina@yahoo.com](mailto:pruteanu_augustina@yahoo.com)

## ABSTRACT

Nettle (*Urtica dioica* L.) is a well-known plant species medicinally and is used extensively in pharmaceutical formulations and is also used for a variety of human ailments. This crop has gained the interest both scientifically and commercially because it is the source of many added-value natural products by exploiting all the plant parts (stem, leaves, roots and seeds).

The technological processing of medicinal plants comprises the technological operations of drying, chopping, separating the cut plants, extracting active principles in different solvents, using different extraction methods, etc. In the production of medicinal plants, the quality of phyto-therapeutic products is given by the quality of the plant raw material, by the quality of the processing works and by the content and quantity of active principles in the plant.

This paper presents experimental data on the separation by size of dried and chopped plants and extraction of valuable active principles from nettle (*Urtica dioica* L.) in water by the percolation process.

Through the application of modern processing operations by producers and processors, many types of medicinal plants can be valorized in a superior manner.

## 1. INTRODUCTION

Nettle (*Urtica dioica* L., Urticaceae), fig. 1, is a perennial herb that grows up to 2 m tall from a creeping rootstock. The stem is square, the leaves are opposite and sharply toothed, and both are covered with stinging hairs. The small greenish flowers are found in clusters in the leaf axils, with male and female flowers on separate plants [11].



Figure 1 *Urtica dioica* [4]

Nettle is common around sloughs, along stream banks, in waste places and moist woods. It prefers damp, rich soil, pH 6 - 7, in full sun or partial shade, and lots of moisture. Extra nitrogen will increase yields. Nettle is said to increase the oil content of valerian, sage, marjoram, mint and angelica if planted 1 nettle:10 of the other plant, and will activate decomposition in compost piles [11].

Seeds of nettle are hard to germinate. Root divisions in the fall are the best method of propagation, using 10 cm pieces of root. The plants are harvested before they flower, while still tender, so the whole plant can be used. If the plants are larger and woody, only the leaves can be used. Two or three harvests are possible in a year. The plants should be kept in a dark place

after drying (they are non-stinging after they are dried). Fresh yields of about 20.000 kg/ha are expected [11].

Scientific literature reports the presence of flavonoids (patuletin, rutin and other heterosides of kaempferol, quercetin and isorhamnetin), coumarins (scopoletin), phenolcarboxylic acids, (0.5% caffeoylmalic acid in *Urtica dioica* [6].

Nettle has great medicinal potential. It has antioxidant, antimicrobial, antiulcer and analgesic properties. Its extract shows in vitro inhibition of several key inflammatory events that cause the symptoms of seasonal allergies. The herb is used as a tea for anemic children. Nettle is nutritionally high in vitamins A, C and D, also minerals iron, manganese, potassium and calcium. It is popularly cooked green in many areas due to its high protein contents [2].

Various parts of the fiber nettle plant can be used as food, fodder and as raw material for different purposes in cosmetics, medicine, industry and biodynamic agriculture. Organically produced fibers are in demand by the green textile industry and show potential that is economically promising [8].

This paper presents experimental data on the separation by size of dried and chopped plants and extraction of valuable active principles from nettle (*Urtica dioica* L.) in water by the percolation process.

## 2. METHODOLOGY

Nettle (*Urtica dioica* L.), used in experiments was identified and harvested from spontaneous flora according to morphological and biological characteristics [1, 3] of the species. Herb was naturally dried, in the shadow up to storing humidity (13 %, at most), cleaned of foreign bodies (inorganic materials or other plants, damaged parts) according to provisions from Pharmacopoeia [9,10], then it was chopped in bulk by medicinal plants chopper of HerbCut model TS (fig.3 a) , equipped with a knife of gate shear type set at 4 mm size.

In order to determine the dimensional characteristics of the chopped plant material, five samples were analyzed, for each sample was weighed on the precision scales a quantity of 120 g of plant material that was sieved on the sieve classifier (fig.3 b), at the amplitude of 50 mm, for 5 minutes. On each sieve was found a quantity of plant material that represented the totality of fragments with smaller sizes than the meshes of the upper sieve, and with larger sizes than the meshes of the sieve through which it passed.

For thyme chopped at 2 mm, the sieve setting was the following one: collector – 2.2 – 3.15 – 4.5 – 6.3 mm, and the collecting of material on sieves in presented in figure 2.



Figure 2 – Nettle fragments separated on sieves with different meshes

After setting the dimensional fractions, was passed to the extraction of bioactive substances in each fraction. The aqueous extract was obtained by percolation using a Timatic percolator, (fig. 3 c). They were weighed by 0.5 kg of nettle, for each of the four fractions, these were introduced one at a time in a special cloth bag and then inserted into the 12 liter percolating compartment, adding distilled water to the appropriate level. The extraction time was 180 minutes, at a pressure of 3 bar.

For extracts obtained from each fraction were made dilutions and were measured quantitatively the spectra of absorption with the UV-VIS spectrometer with double fascicule.

For the analysis of extracts with the spectrometer, was first performed a correction to the baseline of 380-780 nm with distilled water, then the extracts were diluted with the dilution factor 500/1 and 1000/1 for water extracts.

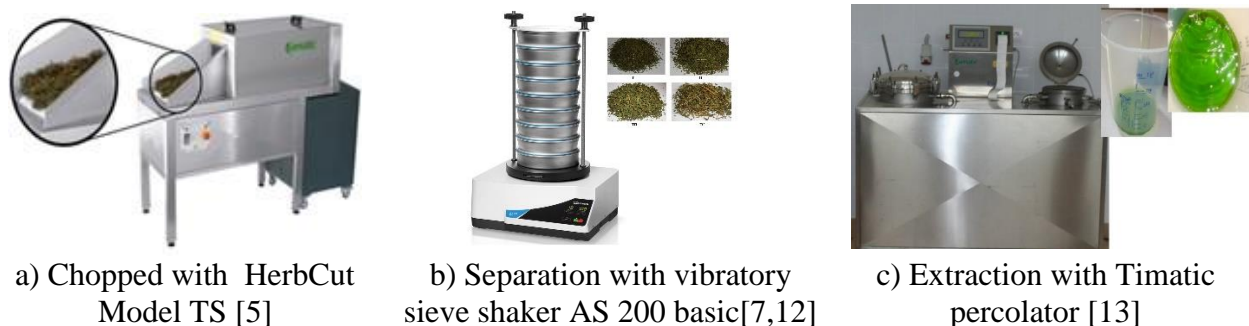

Figure 3 – Equipments for processing medicinal plants of nettle

### 3. RESULTS

Mass and percentage values obtained after classifying are shown in table 1.

Table 1 – Distribution by fraction sizes of nettle fragments

Limits of dimensional fractions of nettle [mm]	Fraction	Sample number[g]					Average of samples [g]	Percentages [%]
		1	2	3	4	5		
0.1-2.8	I	17.10	16.08	17.09	16.18	15.46	16.38	13.65
2.9-4.0	II	70.46	72.14	68.26	71.18	73.85	71.18	59.32
4.1-5.6	III	20.34	17.90	21.67	19.85	18.55	19.66	16.39
5.7-8.0	IV	12.10	13.87	12.98	12.79	12.14	12.78	10.65
<i>Sample average [g]</i>		<i>120</i>	<i>120</i>	<i>120</i>	<i>120</i>	<i>120</i>	<i>120</i>	<i>100</i>

After analyzing the spectra of absorption obtained, it was possible to state the concentration for each extract obtained from the thyme fractions.

The spectra of absorption for the extracts obtained from nettle fractions in water are shown in figure 4 with dilution factor 1/500.

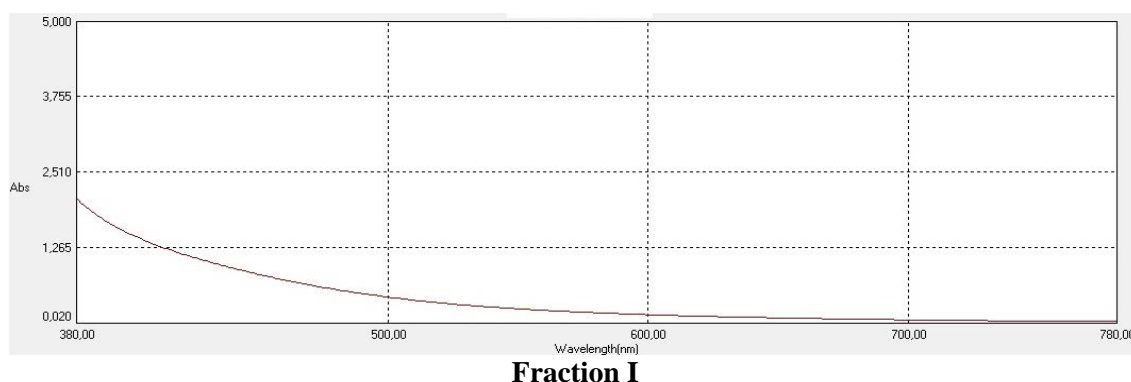



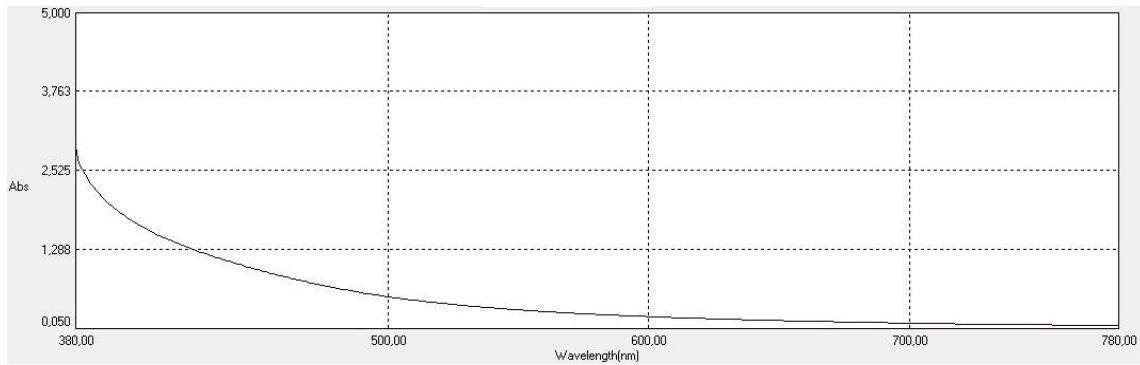

**Fraction II**

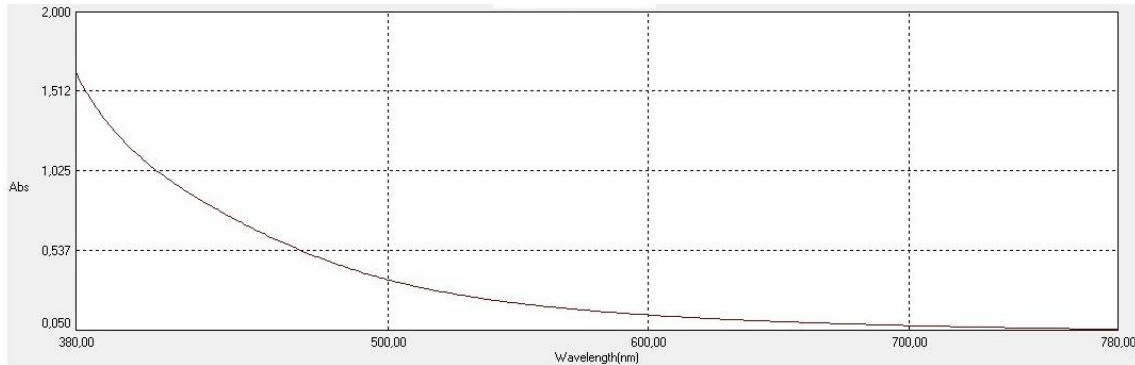

**Fraction III**

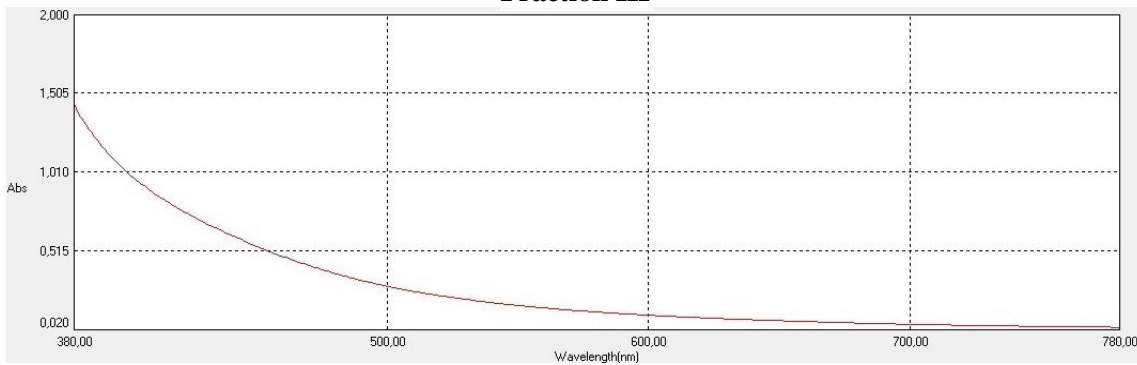

**Fraction IV**

Figure 4 - Spectrograms with dilution 1/500 in water for nettle fractions

The spectra of absorption for the extracts obtained from nettle fractions in water are shown in figure 5 with dilution factor 1/1000.

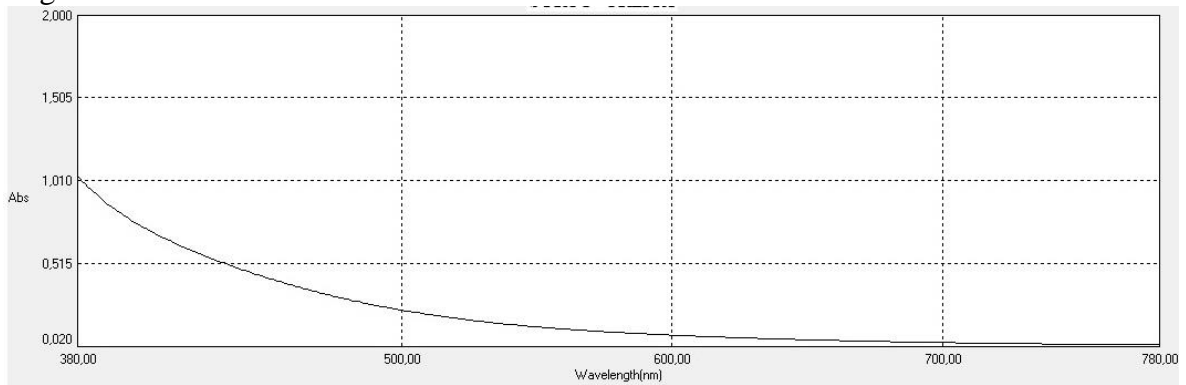

**Fraction I**

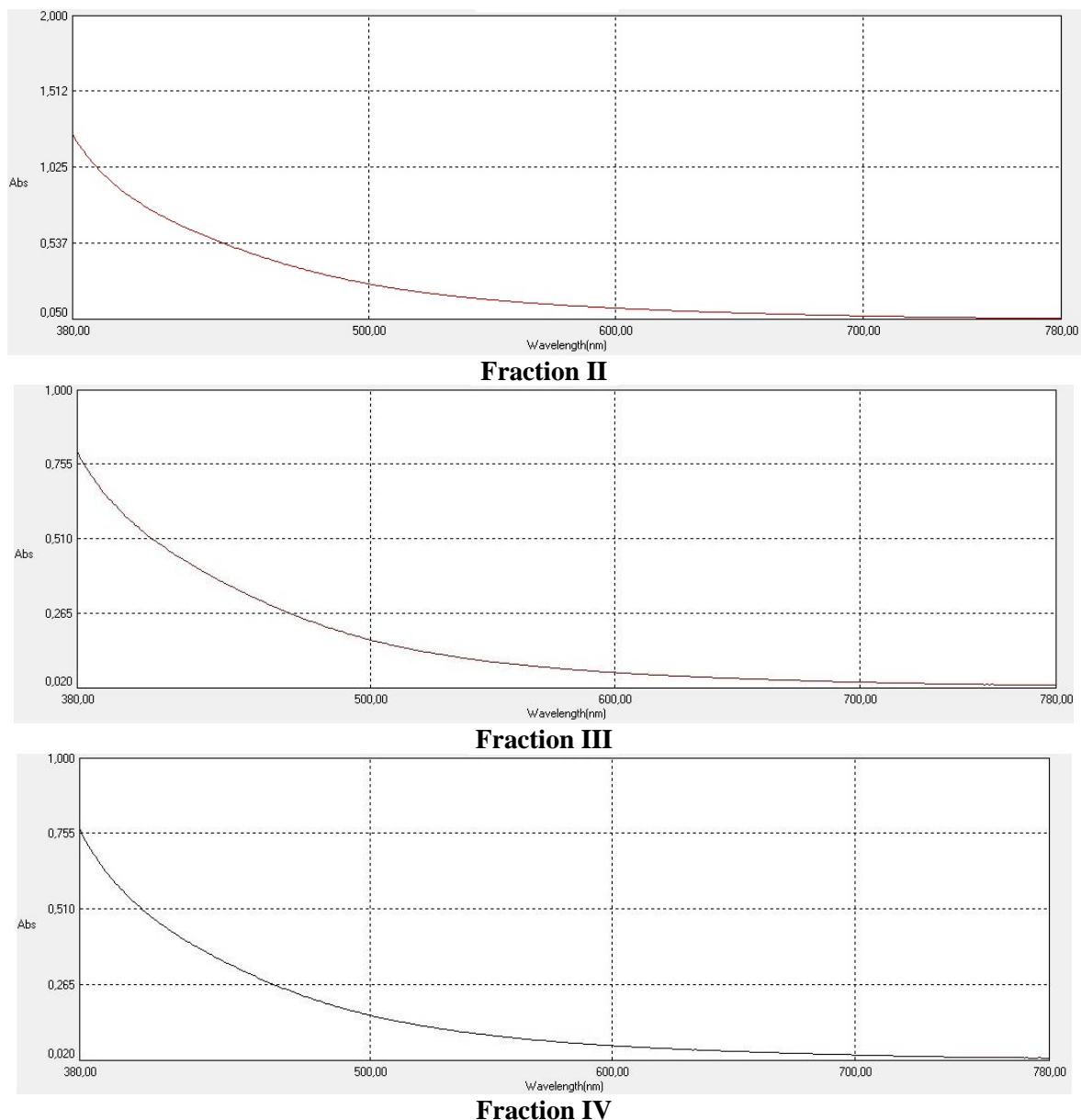

Figure 5 - Spectrograms with dilution 1/1000 in water for nettle fractions

#### 4. CONCLUSIONS

From analyzing the data of the table 1 on the distribution by fraction sizes of nettle fragments depending on the mesh size of the classifier, recommendations can be given regarding the process of sorting medicinal plants

Fragments and sizes of fractions can be identified: between 0.1 - 2.8 mm fraction I, between 2.9 - 4.0 mm fraction II, between 4.1 - 5.6 mm fraction III and between 5.7 - 8.0 mm fraction IV.

From table 1 is observed the maximum percentage was obtained in fraction II (59.32 %), followed by fraction III (16.39 %), then fraction I (13.65%) and fraction IV (10.65 %).

Data obtained from spectrograms offers information regarding the qualitative and quantitative analysis of water extracts from the nettle. The qualitative analysis is identified through the spectrum of absorption from which structural information can be deduced on the basis of peaks. The quantitative analysis is identified from the amplitude of absorption and

depends on the concentration of the main substance in the solution, the substance (phenolic compounds) with antioxidant, antimicrobial, anti-inflammatory character etc.

The spectra from diluted water extracts of nettle show a maximum absorbance of 2.6 for fraction II, 2.4 for fraction I, 1.6 for fraction III and 1.45 for fraction IV at a dilution of 500/1. For dilution of 1000/1 the maximum absorbance show at fraction II (abs. = 1.1), at fraction I (abs. = 1.0), at fraction III (abs. = 0.8) and at fraction IV (abs. = 0.75).

General conclusion is that dry bulk nettle at 4 mm is well separated on the site with the holes dimensions of 2.9-4.0 mm. Extracts in water obtained from nettle fragments of these dimensions have a high concentration in phenolic compounds.

The sorting of medicinal plants on dimensional fractions is an important premise for making quality phyto-therapeutic products.

Knowing the dimensional characteristics of the plant material is important for improving the processes of separation and extraction, for building specialized equipment with high performances in processing medicinal plants.

## References

- [1] Ardelean A., Mohan Gh., *Romanian Medicinal Flora*, All Publishing House, Bucharest, 2008.
- [2] Bisht S., Bhandari S., Bisht N. S., *Urtica dioica (L): an undervalued, economically important plant*, Agricultural Science Research Journals Vol. 2(5); pp. 250-252, May 2012.
- [3] Bojor O., *Guide of medicinal and aromatic plants from A to Z*, Ed. Fiat Lux, Bucharest, 2003.
- [4] Chirilă M., Cioară I., *Nettle fiber (Urtica dioica), between myth and reality*, Buletinul AGIR nr. 3/ iulie – septembrie 2016, pp. 19-25.
- [5] Muscalu A., Prutenu A., David L., *Chopping of medicinal and aromatic plants*, ISB-INMATEH Agricultural and Mechanical Engineering 2014, Bucharest, pp. 103-110.
- [6] Nencu I., Vlase L., Istudor V., Tamas M., *Preliminary research regarding Urtica urens L. and Urtica dioica L.*, Farmacia, 2015, Vol. 63, 5, pp. 710-715.
- [7] Pruteanu A., David L., Vlăduț V., Muscalu A., *Researches on quality of nettle (Urtica dioica) screening process in order to obtain bioactive extracts*, U.P.B. Scientific Bulletin, Series D, Vol. 79, Issue 1, 2017, pp. 267-278.
- [8] Vogl C.R., Hartl A., *Production and processing of organically grown fiber nettle (Urtica dioica L.) and its potential use in the natural textile industry: A review*, Volume 18, Number 3, 2003, American Journal of Alternative Agriculture, pp. 119-128.
- [9] \*\*\* *European Pharmacopoeia*, The Fifth Edition, 2005.
- [10] \*\*\* *Romanian Pharmacopoeia*, Edition X, Medical Publishing House, 1993.
- [11] <https://www.gov.mb.ca/agriculture/crops/production/stinging-nettle.html>
- [12] <https://www.retsch.com/products/sieving/sieve-shakers/as-200-basic/function-features/>
- [13] <http://www.timatic.it/index.php/en/products/extractors-of-active/timatic-duo>

# ROBOTS FOR INTERVENTION AND EVALUATION OF THE SITUATION IN DISASTER AREAS

Radu-Iulian Rădoi<sup>1</sup>, Ștefan Trache<sup>2</sup>, Alin Mocioi<sup>2</sup>, Iulian-Claudiu Duțu<sup>3</sup>

<sup>1</sup>INOE 2000 – IHP Bucharest;

<sup>2</sup>“Alexandru Ioan Cuza” Police Academy – Fire Department;

<sup>3</sup>University Politehnica of Bucharest - Faculty of Biotechnical Systems Engineering

## ABSTRACT

Periodically in the world take place disasters such as explosions followed by fires, earthquakes, industrial or nuclear accident. The intervention of rescuers after disasters is often dangerous. It is dangerous for people to get into the scene immediately because at that time there may be an earthquake replica or, in case of fires, an explosion of combustible gas containers or leakage of dangerous substances.

In some countries mobile robots have developed that can enter in places where man can not. These robots are equipped with various sensors for collecting information. Information obtained with specialized robots enables rescue experts to reduce response time and intervene on-site without risk to personnel.

The paper presents some robot models, an example of a block diagram with components and types of missions that disaster intervention robots can perform.

## 1. INTRODUCTION

Robots developed by research of firms or universities from US, Japan, EU, Russia and others, have different sensors, obstacle detection systems, high resolution cameras, data transmission systems and teleoperation systems. Robots can be configured as required with different sensors and modules to participate in different types of missions. Some variants have autonomous navigation systems or based on a predefined route. These robots are operated by teams that collaborate with the intervention teams (firefighters, rescuers, volunteers) [1]. Information obtained through specialized robots enables rescue experts to reduce response time and intervene on-site without risk to personnel. Some robot models have been used in nuclear contaminated areas (e.g. Fukushima power plant).

## 2. MODELS OF INTERVENTION ROBOTS REALIZED IN THE WORLD

The PackBot robot (figure 1) is a multi-mission robot developed and manufactured by Endeavor Robotics [2]. It was designed for use by fighters in dangerous missions in areas of high-threat combat. The robot can perform surveillance and reconnaissance missions, CBRN detection, the release of objects on roads or buildings, the handling of explosive objects and the inspection of vehicles and people.

The robot has a length of 68.6 cm with the front tracks being folded and 88.9 cm with the front tracks extended. The height without the manipulating arm is 17.8 cm and the width with front tracks is 52.1 cm. It weighs about 10.89 kg without batteries.

---

<sup>1</sup>Cutitul de Argint street, No. 14, Bucharest, Romania, Tel. +4021 336 39 91, [radoi.ihp@fluidas.ro](mailto:radoi.ihp@fluidas.ro)

<sup>2</sup>Soseaua Morarilor, No. 3 Bucharest, Romania, tel. +4021 2555668

<sup>3</sup>No.313 Splaiul Independentei, Bucharest, Romania , [iulian\\_claudiu.dutu@upb.ro](mailto:iulian_claudiu.dutu@upb.ro)

The robot is equipped with a wide-angle inspection camera, a large zoom camera, and white and infrared light sources.

The robot is equipped with a 2.4 / 4.9 GHz digital communication system, two way radio system and GPS receiver. Robot operation is done remotely by two game-style hand controllers. The operator control unit can store high-resolution images and display the location and status of the battery. The two Li-ion batteries provide robot operation for 4 hours. This robot moves at 9.3 km / h and can climb 60 degrees slopes.



Fig. 1 Endeavor Robotics Packbots for emergency situations (Photo: army-technology.com)

Another robot named Octopus (figure 2) developed by Waseda University for Disaster Response wanted to be mobile and to be able to remove the debris from the collapsed buildings [3]. It is provided with 4 arms with grippers for removing debris. The 4 folding tracks allow it to overcome obstacles and provide stabilization in situations where there is a danger of rollover. The 4 arms can also be used to stabilize it in certain situations. The robot is hydraulically driven and is operated by two operators.

The robot arms can each raise about 200 kg. The robot can carry extra equipment, including a remotely operated chain saw and a laser capable of cutting through the stone.



Fig. 2 Octopus, developed by Waseda University in Japan (Photo: Waseda Univ.)

The Mastiff robot (figure 3) is designed with tracks that allow it to cross obstacles including stairs [4]. It is a versatile robot that can be equipped with 360 degree camera, LED lights and multi-axis arm. The robot arm allows the operator to open doors, move debris and inspection

of objects. Various options are available for the robot, such as: gripper tools, HAZMAT sensors and storage case. The operating time can reach 8 hours, the maximum travel speed is ~ 2 km / h, the ground clearance is 50 mm, the dimensions of robot are: W ~ 500 mm, L ~ 1000 mm, H ~ 660 mm. The optional arm can be with 4 or 6 axes, and the full load with the fully extended arm is ~ 9 kg.



Fig. 3 The rescue robot HD2 - “Mastiff” developed by the SDR Tactical (Photo: sdr tactical.com)

**3. STRUCTURE OF THE INTERVENTION ROBOTS**

Robots for intervention or field data collection in areas of disaster have a structure according to the scheme of Figure 4. They are made in the form of a mobile platform built as a housing with tracks, wheels and suspension system, electric motors, transmission, brakes, and clutches. The power source is a Li-ion battery that provides a few hours of autonomy. The control system contains a series of navigation / positioning sensors such as GPS receiver, 3-axis accelerometer, gyroscope, magnetometer, atmospheric pressure sensor. The platform can be equipped with an obstacle detection system that helps the operator in certain situations when the visibility is not good or with an autonomous navigation system for return to the starting point in case of radio link loss. In this case the system uses the log with previously stored GPS coordinates.

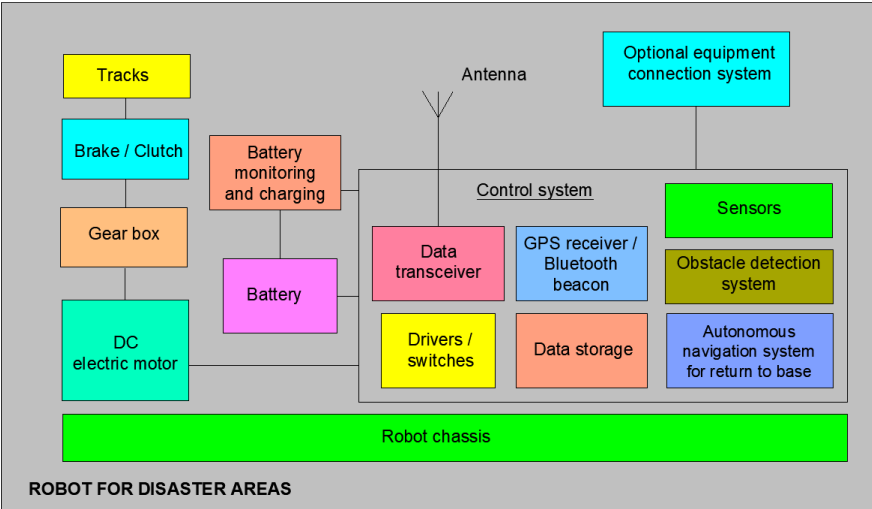

Fig. 4 Example for a block diagram of an intervention robot

For remote control, the robot can be equipped with a 2.4 GHz digital radio communication system that can receive the information transmitted by the robot sensors and provide commands for moving, lighting, directing video cameras or to various optional modules. The robot may be equipped with optional modules to perform specific tasks: gas detection, radiation, fire detection, finder for surviving people, area recognition, or multi-axis arm equipped with a gripper to drive devices or move objects. For mounting optional modules, the robot platform is equipped with mechanical fastening systems and connectors for electrical signal coupling. Optional modular equipment for the robot can be: high resolution video camera (Figure 5) [5], high zoom inspection camera, IR or UV camera (Figure 6) [6], Multi gas detector, radiation sensor, microphone, LED projector, aerosol fire extinguishing system, etc.



Fig. 5 Camera full HD Toshiba IK-HR1D



Fig. 6 UV industrial camera (Photo: visionconnection.com)

Remote control of robots is done via radio link with a control unit equipped with screen and various control switches. Radio communication can be done via 2.4 GHz Wi-Fi, via digital coded channels or by GSM network (gprs, 3G). The COFDM encoding system is immune to interference being used in DVB broadcasts and also introduced in military surveillance [7]. COFDM (Coded Orthogonal Frequency Division Multiplexing) is a modulation scheme that divides a single digital signal across multiple carriers simultaneously. The signals are sent at right angles to each other (hence, orthogonal) so they do not interfere with each. This gives resilience to multipath fading. Such a control unit is that of figure 7 made by Sdr Tactical in the USA. This is included in a Pelican briefcase of dimensions 360 x 300 x 200 mm, being weather resistant and durable.



Fig. 7 Operator control unit - OCU (Photo: robotshop.com)

The unit uses COFDM radio system and has a 7 "color display. The user interface is made with Industrial Joysticks and includes the following components: Video Server, Decoder,

Data Control Bridges, Network Switches, etc. The internal battery has a 4 hour autonomy and an external battery or a source for extended deployments can be used. As an indicator, the unit contains: radio status, signal strength indicator and 4 line data LCD for robot and remote status and setup.

### **3. MISSIONS THAT CAN BE PERFORMED BY ROBOTS FOR DISASTER INTERVENTION**

The basic mission of the robots for site disaster intervention and assessment is to collect field information with the help of specialized sensors configured specifically for each type of mission and the preliminary processing of the information obtained from the place of intervention, at the command center. The information obtained by the operational team can be used as informational support. The commander of the intervention can make on-site decisions and the information can be later transmitted to the dispatcher for off-line processing.

The missions that such a robot can perform are:

- Specific mission to enter buildings affected by explosions or disasters (collapse of installations construction or amenities)

For this type of mission, the robotic mobile platform is equipped with: operating arm for various devices or objects, video camera, UV / IR camera, LED projector, microphone and gas detector.

- A specific task of seeking victims in burned buildings, in rooms adjacent to the burned ones

For this type of mission, the robotic mobile platform is equipped with: operating arm for various devices or objects, video camera, UV / IR camera, LED projector, microphone and gas detector and extinguishing agent with aerosol.

- Accidents and technological damage

For this type of mission, the robotic mobile platform is equipped with: operating arm for various devices or objects, video camera, UV / IR camera, LED projector, microphone and gas detector and extinguishing agent with aerosol.

- Accidents involving the transport of dangerous goods

For this type of mission, the robotic mobile platform is equipped with: operating arm for various devices or objects, video camera, UV / IR camera, LED projector, microphone and gas detector and extinguishing agent with aerosol.

- Detection of potentially explosive atmospheres

For this type of mission, the robotic mobile platform is equipped with: operating arm for various devices or objects, video camera, UV / IR camera, LED projector, microphone and gas detector and extinguishing agent with aerosol.

- Detection of hazardous chemicals

For this type of mission, the robotic mobile platform is equipped with: operating arm for various devices or objects, video camera, UV / IR camera, LED projector, microphone and gas detector and extinguishing agent with aerosol.

- Radiation detection

For this type of mission, the robotic mobile platform is equipped with: operating arm for various devices or objects, video camera, UV / IR camera, LED projector, microphone and gas detector and extinguishing agent with aerosol.



## 5. CONCLUSIONS

Disaster intervention robots can enter into tight spaces or places dangerous for people, right after the disasters occur.

Robots can collect information that is helpful in making quick decisions about the intervention of the evacuation teams.

These robots can be equipped with various equipment for detection of hazardous substances or radiation, aerosol fire extinguisher device, as well as with multi-axis arm for handling objects.

Through video cameras, images can be captured from the spot in the visible, IR or UV spectrum, images that can help identify survivors or imminent dangers.

### References

- [1] <http://robohub.org/robots-to-the-rescue/>
- [2] <http://endeavorrobotics.com/products#510-packbot>
- [3] <https://www.waseda.jp/top/en-news/24089>
- [4] <https://www.robotshop.com/en/superdroid-hd2-s-mastiff-tactical-surveillance-robot-w-5dof-arm.html>
- [5] [http://www.toshibacameras.com/products/prod\\_detail\\_ikhr1d.jsp](http://www.toshibacameras.com/products/prod_detail_ikhr1d.jsp)
- [6] <http://visionsconnection.com/UV-Camera.html>
- [7] [https://www.enterprisecontrol.co.uk/UserFiles/Next%20Generation%20COFDM%20Microwave%20Links%20for%20Military%20Surveillance\(1\).pdf](https://www.enterprisecontrol.co.uk/UserFiles/Next%20Generation%20COFDM%20Microwave%20Links%20for%20Military%20Surveillance(1).pdf)

# EVALUATION OF ENVIRONMENTAL IMPACT BY USING CONTROL LISTS

Rusănescu Carmen Otilia<sup>1</sup>, Biriş Sorin Stefan<sup>1</sup>, Paraschiv Gigel<sup>1</sup>, Begea Mihaela<sup>1</sup>,  
Voicu Gheorghe<sup>1</sup>, Rusănescu Marin<sup>2</sup>, Cîrîc Alexandru<sup>1</sup>, Stoica Dorel<sup>1</sup>  
Țucureanu Marina Cristinela<sup>1</sup>

*Polytechnic University of Bucharest of Romania, Faculty of Biotechnical Systems Engineering; Splaiul Independentei, no.313, District 6, Bucharest, Romania*

<sup>1</sup> Polytechnic University of Bucharest, Faculty of Biotechnical Systems Engineering / Romania;

<sup>2</sup> Valplast Industry Bucharest

E-mail: rusanescuotilia@gmail.com

## ABSTRACT

This paper describes the method of environmental impact assessment using the control lists. Control lists contains a series of questions that will be considered to identify whether or not the project under consideration has significant environmental effects. Control lists are: simple, descriptive, questionnaires, scale control lists, weighting. Control lists are used to evaluate the quality of the report to the assessment study for the purpose of making the decision to issue the environmental agreement; to improve the environmental impact assessment process.

## 1. INTRODUCTION

The control lists is useful in the environmental impact assessment process. The user of the checklist will analyze whether the report to the evaluation study fulfills two objectives: it provides the decision makers with all the information necessary to make the decision to issue or reject the environmental agreement; allows effective communication with stakeholders and the general public so that they can make a useful comment on the project and its environmental effects [2] Control lists can be used in two purposes: to assess the quality of the report to the assessment study for the decision to issue the environmental agreement; to identify the need to improve the environmental impact assessment process [1].

## 2. METHODOLOGY

Checklists allow the ordering of ideas, facilitate the collection of data and information, and allow the viewing of large amounts of information and data, so that the impact can be better located.

Control lists can describe the impact on the environment, can be achieved through the development phase of the anthropic project (planning and design phase, construction phase, management phase, closure phase) identifies the issues to be considered in the EIA process: description of the location of the development project, the scale of design, its design and its type (industrial, residential); topography and land use within and in the vicinity of the site, land use history, possible contamination or historical pollution (heavy metals pollution with a high environmental retention, soil pollution generated by an unplanned landfill); proximity of the site in relation to residential areas, factories, schools, hospitals, communication routes, protected areas, lakes, rivers; the history of extreme natural events (seismicity, volcanism); geomorphological risks (landslides, soil erosion); hydrological aspects (river flow and

configuration, water runoff on the slopes, lakes) and hydrological risks (flood risks or surface water pollution); local ecology (diversity or rarity of flora, fauna); air pollution and noise pollution due to project development; aesthetics of the development project (aesthetic landscape modification, fragmentation and alteration of the visual landscape structure); the economic impact of project development (improving quality of life, increasing income, lowering unemployment); the planning regulations and the legislative requirements to be met by the proposed development project.

These aspects can fit into the environmental change that can be monitored and corrected through a series of actions:

- establishing an acceptable time interval between sampling, measurements or observations (one month after starting anthropogenic activity, one year or more if the observed changes were minor or insignificant);
- repeatable measurements and observations in time and space;
- protected and correctly observed environmental sampling procedures;
- using comparable analytical and supervisory techniques.

There are five types of checklists [3]:

- simple control lists are lists of standardized environmental components based on project types (energy production installations, transport systems) or areas (marine, coastal);
- descriptive control lists provide for each component considered impact forecast;
- the questionnaires consist of questionnaires related to project activities and their effects on environmental components;
- scale control lists provide techniques for hierarchy of the examined alternatives according to the expected impact on each component;
- weighting lists provide techniques for measuring, weighing and aggregating elemental impacts in synthetic impact indices.

The simple, descriptive, control lists, questionnaires are qualitative lists and are designed to prevent the neglect of some fundamental aspects of impact.

The list of questions provides, for each type of impact, references to the appropriate forecasting technique and sometimes to the measurement of changes in environmental factors. There are questions grouped by impact categories (physical characteristics of the land, ecological characteristics, modeling of the area, infrastructures, social services, pollution) divided into subcategories (soil, water, climate, occupation, labor supply), [4].

List of questions about the soil component component [5, 6]:

- a) Are the geology of the area problematic in the context of the type of project being examined?
- b) Does the project involve excavations or land movements that may have adverse consequences, such as soil erosion?
- c) How are soils classified from the agricultural point of view?

Scale and weight control lists are, quantitative lists that also involve a scoring criterion, with a detailed impact description. Checklists of this type are operational tools for impact assessment phases.

The checklist includes a number of questions that will be considered to identify whether or not the project under consideration has significant environmental effects. The control list is organized in two parts: the first two selection criteria of the framing phase [4, 7]:

- a) the characteristics of the project;
- b) location of the project.

On both sides there is a number of main questions in column 1, each of which is followed by other questions. The main questions relate to the possibility of an effect as a

consequence of project placement both in the construction phase and in the phases of operation and decommissioning. The one who uses the list will respond to each subsidiary question with one of the following 4 possible answers: Yes - if an effect may occur; No - if an effect is not expected; whether an effect is likely to occur or not; NC (not applicable) - if the question is not relevant to the project in question. Responses are entered in column 2.

For "yes" responses, the next step is to decide if the effect is likely to be significant.

Identifying the possibility that the effect is significant [4,7].

For each effect in which column 2 is answered by "Yes" questions will be asked (The nature of the effect - the impact is particularly complex or is it unusual in the area? The size or importance of the effect - how much will the existing situation change? geographic effect - on which area the effect will be felt? How many people or how many other receptors will be affected? Are resources or other valuable or rare features of the environment affected? Is there a risk of overcoming environmental standards? Impact will be in the short, medium or long term? Will the impact be permanent or temporary?) and the answer will be entered in column 3 of the controllist.

After completing column 3, it will be decided whether the project will be subject to an environmental impact assessment.

It may be required to carry out the environmental impact assessment if there is only one "Yes" answer in Column 3. As there are more "Yes" answers, the more justified is the request for the environmental impact assessment. The presence of "?" in columns 2 or 3 indicates that there are uncertainties about the occurrence or significance of the effect, in which case the environmental impact assessment is required because this process will lead to clarification of the uncertainties.

Table 1: Ramping stage checklist [4,7]

Project features			
Questions		Yes / No / ? / NC	The effect is significant? Why?
Question - Will the project involve any of the following actions that will create changes in the area as a result of the new investment?			
1.	Permanent or temporary change of land use, coverage or topography?		
2.	Release of existing land of vegetation and buildings?		
3.	New land use?		
4.	Preliminary investigation of the construction phase (eg soil tests, drillings)?		
Summary of comments on the characteristics of the project indicating that an environmental impact assessment is required and a report on the assessment study.			

Environmental impact assessment depends on interactions between activities and environmental components. The environmental impact assessment is made according to the following rules: 3 criteria of appreciation for which scores 1, 3 or 5 will be assigned, according to the tables below.

Table 2: Expansion and control (E) [4,7]

Punctual	Impact is limited to work	Score: 1
Local	The impact is limited to the location of the unit	Score: 3
General	Impact exceeds the location of the unit	Score: 5

Table 3: Gravity (G): extent of impacts [4,7]

Small	The effect on the environment disappears on its own within a day	Score: 1
Moderate	Eliminating effects requires moderate efforts and durations	Score: 3
Major	Effects persist and their removal requires investment	Score: 5

Table 3: Frequency (F): probability of occurrence [4,7]

Low	Pollution occurs sporadically (quarterly or annually)	Score: 1
Average	Pollution occurs weekly or monthly	Score: 3
Great	Pollution occurs continuously or daily	Score: 5

Impact value calculation:

$$V = E \times G \times F \quad (1)$$

The calculation of the impact value (V) is made by the formula (1) after which the following interpretations will be made:

Table 4: Meaning of Environmental Impact [4,7]

Impact value	Level	Significance
$V \leq 9$	Acceptable (No specific actions required)	Environmental Impact insignificant (IN)
$9 < V \leq 27$	Moderate (Limited scale upgrades required)	Environmental Impact significant (IS)
$V > 27$	Critical (Major improvements required)	

### 3. CONCLUSIONS

This paper describes the environmental impact assessment using the control lists. List of control includes a series of questions that will be taken into account to identify whether or not the project under consideration has significant environmental effects. Lists of control are: simple, descriptive, questionnaires, scale control lists, weighting. Lists of controls are used to assess the quality of the report to the assessment study for the purpose of taking the decision to issue the environmental agreement; to identify the need to improve the environmental impact assessment process. The formula for calculating the environmental impact is also presented according to the severity and frequency of the environmental impact.

### ACKNOWLEDGEMENT

This work was supported by Romanian national project PN-III-P2-2.1-BG-2016-0238 / Contract 22BG - Utilization in agriculture of by-products resulted from the manufacture of baker's yeast.

### References

- [1] Rusănescu, C.O., *Ecological Impact Assessment, Matrix Rom București Publishing House*, 2016
- [2] Muntean, O.,L., *Methods of environmental impact assessment*, Cluj-Napoca, 2009.
- [3] Gisotti, G., Bruschi S. *Valutare l'ambiente, Guida agli Studi dell 'Impatto Ambientale*, La Nuova Italia Scientifica, Roma, 1990.
- [4] Clark, B.D., Chapman, K., Disset, R., Waltern, P., Barret, M. , *A Manual for the Assessment of Major Development Proposals*, London, 1981.
- [5] Dee N. et. al., *An Environmental Evaluation System for Water Resource Planning*, Battelle – Columbus Laboratories, 1972.
- [6]Duke K.M. et al., *Environmental Quality Assessment in Multiobjective Planning*, Battelle – Columbus Laboratories, 1977.
- [7]. Carmen Otilia Rusănescu, Cosmin Jinescu, Marin Rusanescu, Mihaela Begea, Olimpia Ghermec, Evaluation of Air Pollution by NO<sub>2</sub>, SO<sub>2</sub>, PM10 in Bucharest, Revista de chimie, nr. 10/2017

# METHODS OF ENVIRONMENTAL IMPACT ASSESSMENT

Rusănescu Carmen Otilia, Țucureanu Marina-Cristinela

*Polytechnic University of Bucharest of Romania, Faculty of Biotechnical Systems Engineering; Splaiul Independentei, no.313, District 6, Bucharest, Romania*

## ABSTRACT

Technological hazards are currently a topical feature of industrial activities. By the devastating effects of the environment, as well as on the economy or the safety of life, they directly affect the economic and social development of the exposed regions. The major accidents that can occur at industrial sites are explosions, fires and toxic emissions. The production of such accidents can have catastrophic consequences, as they result in human losses, "ecological" damage to the natural environment and damage to the property [5].

## 1. INTRODUCTION

Depending on the industrial plant model and the substance used, there are a variety of risk analysis and identification methods worldwide. Methods of risk analysis and assessment carry out hazard identification and risk assessment [5].

The objective of risk analysis is to produce outputs that can be used to evaluate the nature and distribution of risk and to develop appropriate strategies to manage the risk.

Qualitative methods use descriptive terms to identify and record the consequences and probability of events and resultant risk. Quantitative methods identify likelihoods as frequencies or probabilities. They identify consequences in terms of relative scale (orders of magnitude) or in terms of specific values (for example, estimates of cost, number of fatalities or number of individuals lost from a rare species) [3].

Qualitative methods are the most commonly applied, as they are quick and relatively easy to use. Broad consequences and probability can be identified and can provide a general understanding of the comparative risk of events, using a risk matrix separate events into risk classes (ratings) [3].

Semi-quantitative approaches are widely used in an effort to overcome some of the shortcomings associated with qualitative approaches. They are intended to provide a more detailed prioritisation of risks than qualitative risk assessments and take the qualitative approach a step further by attributing values or multipliers to the likelihood and consequence groupings [3].

There are many tools and techniques available in identifying risks processes used in project management and some of them are:

The LOPA method consists on identifying (semi-quantitatively) the estimated probability and (qualitatively) the severity level of an initiating event, and calculating the modified probability of the hazardous event reduced by the presumption of failure of existing independent protection layers (IPL) [1].

The ARAMIS methodology was developed in an European project co-funded in the fifth Framework Programme of the European Commission with the objective to answer the specific requirements of the SEVESO II directive. It offers an alternative to purely deterministic and probabilistic approaches to risk assessment of process plants [7].

Hazard and Operability Analysis (HAZOP) is a structured and systematic technique for system examination and risk management. In particular, HAZOP is often used as a technique for identifying potential hazards in a system and identifying operability problems likely to lead to nonconforming products [9].

Checklist Analysis is a hazard evaluation procedure using one or more pre-prepared lists of process safety considerations [10].

The MOSAR method is made up of two modules. Module A coincides with macroscopic risk analysis on an industrial site, requiring a preliminary risk analysis. Module B is used to analyze in detail the scenarios identified in Module A [4].

OCTAVE (Operationally Critical Threat, Asset, and Vulnerability Evaluation) is a risk-based strategic assessment and planning technique for security. It is a single source comprehensive approach to risk management [6].

HAZAN is a hazard analysis and is a term used in safety engineering for the logical, systematic examination of an item, process, condition, facility, or system to identify and analyze the source, causes, and consequences of potential or real unexpected events which can occur. A hazard analysis considers system state (e.g. operating environment) as well as failures or malfunctions. Hazan is the identification of undesired events that lead to the materialization of a hazard, the analysis of the mechanisms by which these undesired events could occur, and, usually, the estimation of the consequences. Every hazard analysis consists of the following three steps [8].

The CARMIS method is used for quantifying and qualitatively determining the level of risk for technological installations and is addressed to economic operators using hazardous substances in the production process.

## 2. METHODOLOGY

There are multiple definitions of risks depending on the information security standard applied.. The fundamental definition according to a lot of information security standards is that a risk is the product of the probability of a threat to occur and its accompanying consequences, see Equation 2.1 [5].

$$\text{Risk} = \text{Probability} * \text{Consequence} \quad (1)$$

The objective of risk analysis is to produce outputs that can be used to evaluate the nature and distribution of risk and to develop appropriate strategies to manage risk. Events or issues with more significant consequences and probability are identified as „higher risk“ and are selected for higher priority mitigation actions to lower the likelihood of the event happening and reduce the consequences if the event were to occur [2].

Table 2.1: The Risk Raiting

RISK RATING		
High Risk	Medium Risk	Low Risk
1-6	7-15	16-25

Qualitative methods use descriptive terms to identify and record consequences and probability of the events and resultant risk. Quantitative methods identify probability as frequencies or probabilities. They identify consequences in terms of relative scale or in terms of specific values [2].

For both qualitative and quantitative methods it is important to invest time in developing appropriate rating scales for likelihood, consequence and resultant risk. The full range of risk situations likely to be encountered within the scope of the exercise should be considered when developing rating scales [2].

Qualitative approaches to risk assessment are the most commonly applied. Qualitative risk assessment methods are quick and relatively easy to use as broad consequences and probability can be identified and they can provide a general understanding of comparative risk between risk events, and the risk matrix can be used to separate risk events into risk classes. A logical systematic process is usually followed during a qualitative risk assessment to identify the key risk events and to assess the consequences of the events occurring and the probability of their occurrence [2].

Table 2.2: Classification of risks

Consequence	Probability				
	L1 Almost certain	L2 Likely	L3 Possible	L4 Unlikely	L5 Rare
C1 - Catastrophic	1	2	4	7	11
C2 - Major	3	5	8	12	16
C3 - Moderate	6	9	13	17	20
C4 - Minor	10	14	18	21	23
C5 - Insignificant	15	19	22	24	25

Environmental impact assessment methods include the following steps:

1. Setting up the evaluation team;
2. Defining the Analysis System;
3. Field analysis and identification of risk factors in the system;
4. Drawing up and consultation of checklists;
5. Elaboration of fault trees;
6. Evaluating risk factors identified from the point of view of gravity;
7. Evaluating the frequency of initiating events and confidence levels of security barriers;
8. Elaboration of the accident scenario;
9. Estimation of the direct impact on: goods, data and information, infrastructure, people;
10. Evaluation of existing protection, compensation and recovery factors;
11. Evaluating the performance of existing security barriers;
12. Drawing up the security report as a support document for the security management system.



## CONCLUSIONS

The most delicate issue is the identification of risk, due to the diversity of events. Estimates of the probability of industrial risks can be determined by statistical studies, but the chances of obtaining reliable results based on the theoretical relationships are very low. However, the risk analysis remains a problem of great complexity and difficulty.

The CARMIS Method has been materialized by combining the other assessment methods like HAZOP, HAZAN, LOPA, OCTAVE, MEHARI, ARAMIS, Checklist. Using this method, a full degree of risk assessment has been achieved, understanding how the risk may affect the population, employees, the environment and the assets and data belonging to society.

## REFERENCES

- [1] Alejandro Torres-Echeverria, *On the Use of LOPA and Risk Graphs for SIL determination, 17th Annual International Symposium*, October 28-30, College Station, Texas, 2014
- [2] Amo Paithankar, *Hazard Identification and Risk Analysis in Mining Industry*, Department of Mining Engineering National Institute of technology, Rourkela, 2010-2011
- [3] Australian Government, *Risk Management- Leading Practice Sustainable Development Program for the Mining Industry*, September 2016
- [4] Băbuț Gabriel, Moraru Roland, Băbuț Monica Crinela, *Metode integrate de evaluare a riscurilor (II)*, Quality - Access to Success, 2010, Vol. 11 Issue 1/2, p87-91. 5p. 1 Diagram.
- [5] Băbuț Monica Crinela, *Metode de analiză și evaluare a riscurilor aplicabile pentru apasamentele industriale de tip Seveco*, Editura Focus, Petroșani, 2011
- [6] Manolis Fragkos, *Risk Analysis—A valuable tool for organizations/comparative analysis*, Obrela Security Industries, February 2006
- [7] Olivier Salvi, BrunoDebray, *A global view on ARAMIS, a risk assessment methodology for industries in the framework of the SEVESO II directive*, Journal of Hazardous Materials Volume 130, Issue 3, 31 March 2006, Pages 187-199
- [8] <http://ispatguru.com/hazard-hazid-hazan-and-hazop-part-of-safety-and-risk-management/>
- [9] [http://pqri.org/wp-content/uploads/2015/08/pdf/HAZOP\\_Training\\_Guide.pdf](http://pqri.org/wp-content/uploads/2015/08/pdf/HAZOP_Training_Guide.pdf)
- [10] <https://www.oshatrain.org/notes/4bnotes07.html>

# WOOD-BURNING STOVES WITH HIGH EFFICIENCY

Safta Victor - Viorel<sup>1</sup>, Toma Magdalena - Laura<sup>1</sup>, Zăbavă Bianca-Ștefania<sup>1</sup>,  
Boureci Adrian<sup>2</sup>, Ciucă Viviana<sup>3</sup>)

<sup>1</sup>University POLITEHNICA of Bucharest, Department of BIOTECHNICAL SYSTEMS

<sup>2</sup>Captain NICOLAE PLEȘOIANU High School of Râmnicu Vâlcea

<sup>3</sup>Pasteur Institute, Bucharest

## ABSTRACT

In this paper there are reviewed modern versions of wood-burning stoves with high efficiency, presenting the principles of operation and construction structures and highlighting the benefits of using them both in terms of thermal yield and in terms of reducing polluting emissions into the atmosphere.

This issue is of particular importance by providing modern, viable solutions to ensure thermal energy in rural households.

**Keywords:** wood-burning stoves, high thermal efficiency, low pollutant emissions

## 1. INTRODUCERE

In households in rural Romania, wood stoves are commonly used to heat homes and sometimes to produce hot water or cooking.

The use of wood as a fuel is in ecological harmony with the environment, since by correct burning of wood is emitted the same amount of carbon dioxide (CO<sub>2</sub>) as the decomposition of wood by rotting. The amount of carbon dioxide obtained by combustion or natural decomposition of the vegetable mass corresponds to the amount of carbon dioxide that the plant mass is able to receive from the environment throughout its lifetime and converts it into oxygen released into the atmosphere and carbon which is synthesized in its own structure, which represents about half of its mass [1].

Unlike wood, considered renewable fuel, the use of non-renewable fossil fuels (coal, oil, gas) for the production of combustion thermal energy releases and emits enormous amounts of carbon dioxide in the atmosphere, accumulated in millions of years in which these fossil fuels have formed, resulting in an atmosphere global warming through the greenhouse effect.

The wood burning process is as follows: by external heating, the temperature increases and the cellulosic structure of the wood starts to pyrolyze (that is, to decompose by thermal process), some of the decomposition products remaining inside the wood material and others leave the wood material, being released as gases. These gases react with each other, but especially with oxygen from the air, and ignite and burn with flame releasing a great amount of heat. Under the action of heat, the pyrolytic process intensifies resulting a chain reaction in continuous expansion, which leads to the ignition and combustion of the wood [2].

Depending on the combustion conditions (temperature, oxygen concentration, humidity, presence of fireproof products, pH, etc.), the wood pyrolysis process can take place in two ways depending how the wood cellular structure bonds are broken throughout, namely:

- *wood combustion with tar formation* (see Figure 1a), which takes place at a temperature of 300°C and is the "normal" way of wood burning, in which pyrolysis produces a large amount of tar, especially levoglucosan, which decomposes easily in the combustion gases under the

---

<sup>1</sup> Splaiul Independentei 313, Sector 6, Bucharest, 0724017310, saftavictorviorel@yahoo.com

influence of heat;

- *wood combustion with char formation* (see Figure 1b), in which cellulose is first transformed into unstable "active" cellulose, which then decomposes resulting carbon dioxide, water and char, which is the "backbone" of cellulose containing a large amount of carbon.

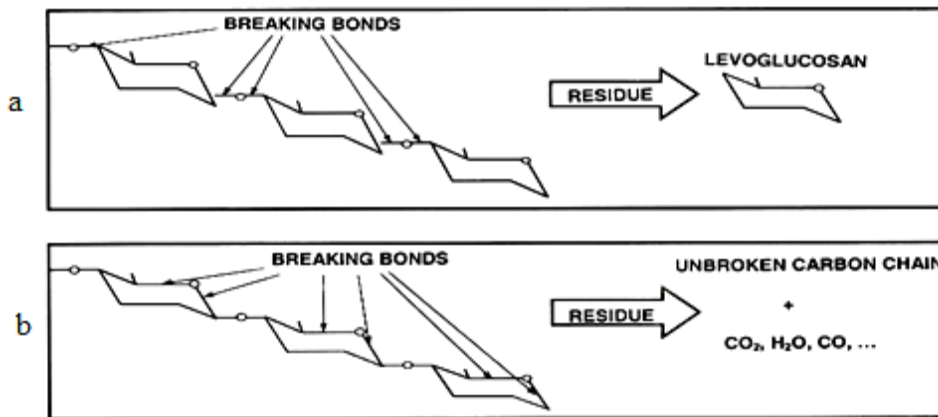

Figure 1: Wood pyrolysis methods [4]

The wood pyrolysis process also depends on certain external factors, such as heating mode, warming-up rate of the material, etc. Therefore, wood products do not have an explicit ignition temperature; the ignition takes place in a certain temperature range where the ignition probability becomes large enough. So the piloted ignition temperature of wood is usually about 350°C, while spontaneous ignition requires a temperature of about 600°C.

From the normal wood burning, the following products results [3]:

- *combustion gases* containing mainly *carbon dioxide* CO<sub>2</sub>, *carbon monoxide* CO, *hydrogen* H<sub>2</sub>, as well as a small amount of hydrocarbons, especially *methane* CH<sub>4</sub>, components which occur at a temperature of approx. 200°C, *pyrolignoic products* (70% water, 20% acetic acid, 5% propionic acid, 3% formalin, etc.), which occur at a temperature of approx. 200°C and disappear at a temperature of approx. 350°C and *tars* which are complex products containing more than 100 different organic compounds in very variable proportions with high calorific value (20000 – 30000 kJ/kg) occurring at temperatures above 200°C; along with the combustion gases in entrained soot too, made in fact from unburned carbon particles;

- *ashes* (carbonaceous residue), i.e. substances in the fuel, inert in terms of combustion (*lignin*, in the case of the wood) in a proportion of 15 – 25% of the initial wood mass;

- *heat reaction*, which is taken up and transported by the combustion gases.

Wood burning is considered *complete* (*perfect* or *theoretical*) if it is characterized by the fact that exhaust gases no longer contain combustible elements (e.g. carbon monoxide or soot).

The wood burning may be *incomplete* if it is characterized by the fact that the exhaust gas contain combustible components. Incomplete combustion may be *chemically incomplete combustion*, characterized by the fact that the exhaust gases contain combustible gases (e.g. carbon monoxide) or *mechanically incomplete combustion*, characterized by the fact that the exhaust gases contain combustible solid particles (e.g. soot). Generally, incomplete combustion produce smoke, which is the visible mixture of liquids in the form of very fine droplets and / or solid particles in suspension. Enhancing the wood burning process means in fact producing as

much heat as possible using a certain amount of wood, through a burning as complete as possible.

## 2. METHODS TO EFFICIENT WOOD BURNING STOVES FUNCTIONING PROCESS

The ways to make wood stoves more efficient refer both to achieve a firmer combustion process (complete combustion) and to reduce their pollutant and toxic emissions.

The wood burning process is mainly influenced by the following factors:

- the quality and condition of wood used for combustion;
- the way in which the burning process takes place;
- the way in which the heat produced during burning is transferred to the environment.

The *quality and condition of wood* are extremely important factors in the efficiency of wood stoves. Thus, the quality of the firewood depends on the species from which it comes: the resinous wood (fir, spruce, etc.) is easier to ignite, while the hardwood (beech, oak, etc.) provides a higher quantity of heat. The condition of firewood is strongly influenced by the moisture content: the *freshly cut or wet firewood* has specific combustion energy of approx. 1 kWh/kg, the *firewood with 60% moisture content* has specific combustion energy of approx. 3 kWh/kg and the *natural dry firewood with 25% moisture content* has a specific combustion energy of approx. 4.5 kWh/kg. When burning wood with high humidity, besides their low combustion energy, their high water content will prevent ignition of combustion gases, allowing them to escape unburned, producing up to 50% potential heat loss and atmospheric pollution. Wood burning with the appropriate humidity can bring important savings (up to 70% in wood volume) with the same burning efficiency in the stoves [5].

The *way the combustion process takes place* must ensure efficient combustion of both the wood and the resultant pyrolysis products, producing their oxidation as complete as possible. Through the constructive design and the advanced burning processes, modern stoves aim at the following objectives:

- up to 50% more energy efficient;
- to reduce by 70% the amount of wood to obtain the same amount of combustion heat;
- to reduce creosote accumulation and risk of clogging or the occurrence of fire in chimneys;
- significant reduction of emissions into the atmosphere of carbon dioxide CO<sub>2</sub> and methane CH<sub>4</sub>, which are greenhouse gasses involved in global warming;
- to reduce soot at allowable levels both inside the stoves and in their emissions, thus preventing the pollution with solid particles of the atmosphere with major health benefits in preventing cancers, bronchial asthma and other serious conditions;
- significant savings in money, time and resources.

To fulfil these goals, two general approaches have been developed: one based on the *non-catalytic combustion of wood* and the other on the *catalytic combustion of wood*. Both approaches proved to be effective, but there are differences in performance in favour of catalytic combustion stoves. Although, most modern stoves on the market are non-catalytic, but the stoves using catalytic combustion are of high quality and are suitable for people who want to introduce new technologies and who are ready to operate and maintain stoves accordingly so that they continue to work with maximum performance.

*Non-catalytic stoves* (see Figure 2a) have a constructive structure designed to provide an optimum environment for a complete combustion. The typical characteristics of these stoves are

the fireplace insulation; the entry and circulation of the combustion air inside the stove so that it is preheated and produces both the direct heating and combustion of the wood at the bottom of the furnace (*main combustion*) as well as the burning of pyrolysis products released by wood heating in the upper part of the furnace (*secondary combustion*), as well as the circulation and evacuation of the resulted combustion gases as efficiently as possible for heating by radiation to the environment and to preheat the combustion air.

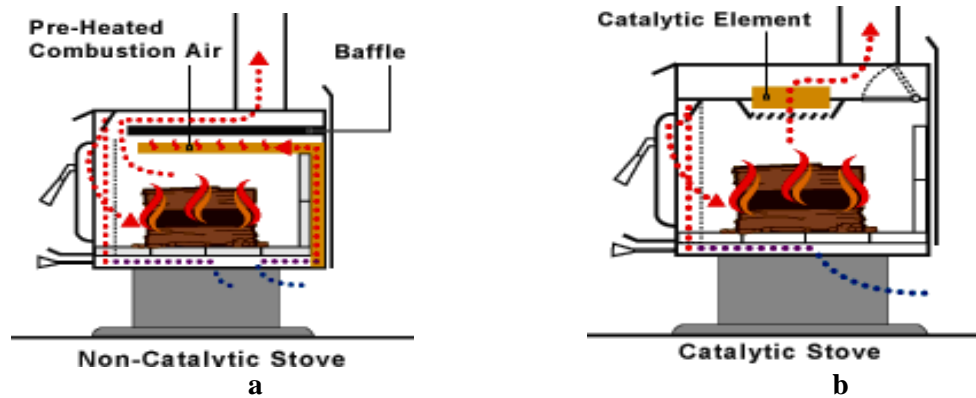

Figure 2: Schemes of modern high-efficiency stoves [5]

*Catalytic stoves* (see Figure 2b) have as particularity the introduction into the constructive structure of a honeycomb type catalytic reactor through which the combustion gases and the soot are passed, which ignite and burn in order to ensure the most complete combustion. Also all catalytic stoves are provided with a catalytic reactor bypass damper that opens during ignition initiation after loading wood into the furnace. It should be noted that the catalytic reactor degrades over time and needs to be replaced. Its durability depends mainly on the user who operates the stove. So, if the stove is properly operated, the catalytic reactor can last for six seasons. Instead, if the stove is overheated, if inadequate fuel quality (treated wood or garbage) is used, if the cleaning and periodic maintenance is not carried out, the catalytic reactor can degrade after only two seasons. Of course, the circulation and preheating of the combustion air (primary and secondary) and the circulation and evacuation mode of the combustion gases have been carefully studied and determined in order to achieve the highest efficiency of these stoves.

*Typical emissions* of wood burning released into the atmosphere are mainly carbon dioxide ( $\text{CO}_2$ ) and water ( $\text{H}_2\text{O}$ ), but other types of chemical products may also be emitted depending on the quality of the combustion. So, the products resulting from wood burning, significant for the atmospheric pollution, are: *smoke*, *carbon dioxide*  $\text{CO}_2$ , *carbon monoxide*  $\text{CO}$ , *toxic gases* resulting from burning wood treated with fire retardants in order to improve the fire performance.

*Smoke* pollutes the atmosphere with solid particles and significantly diminishes its transparency and quality, smoke production being dependent on the quality and type of combustion, the quality and condition of the wood, oxygen supply and others. In comparison with other materials (plastics, rubber, etc.), the burning wood smoke production is minor, but nevertheless it constitutes a measure of the efficiency of the modern wood-burning stoves.

In U.S.A., Environmental Protection Agency (E.P.A.) has imposed performance standards for wood stoves in which the maximum permissible limit for smoke emission is currently 4.5 g/h and will be 2 g/h beginning with 2020. At present, the wood stoves producers, admitted by E.P.A., sell on the market products with smoke production between 1 – 4 g/h [6].

From the *carbon dioxide*  $\text{CO}_2$  emission point of view, an efficient wood burning stove must

provide a combustion quality in which the amount of heat produced is obtained with a minimum amount of wood, reducing to a minimum the pollutant emission of carbon dioxide.

Emissions of carbon monoxide CO, a particularly toxic gas in the atmosphere, are mainly related to the combustion ventilation (a well-ventilated combustion produces an amount of less than 10 g CO/kg of burned wood, whereas an unventilated combustion produces quantities of the order of 100 g CO/kg of burnt wood). In addition, temperature is a significant factor because it has a strong effect on the course of all chemical reactions during burning.

When burning wood treated with *retardants* or *flammable substances*, it is necessary to monitor any resulting toxic products to keep their release within acceptable limits.

### 3. HIGH PERFORMANCE WOOD BURNING STOVE MODELS

As previously shown, modern wood stoves with high efficiency have been developed into two major categories: *non-catalytic wood stoves* and *catalytic wood stoves*.

*Non-catalytic wood stoves* favour both the primary combustion of wood and, in particular, the secondary burning of pyrolysis products through adequate ventilation and preheating of the combustion air. The circulation of combustion air and combustion gases has been routed to achieve the most complete combustion and high thermal efficiency. Figure 3 shows three models of high efficiency non-catalytic stoves.

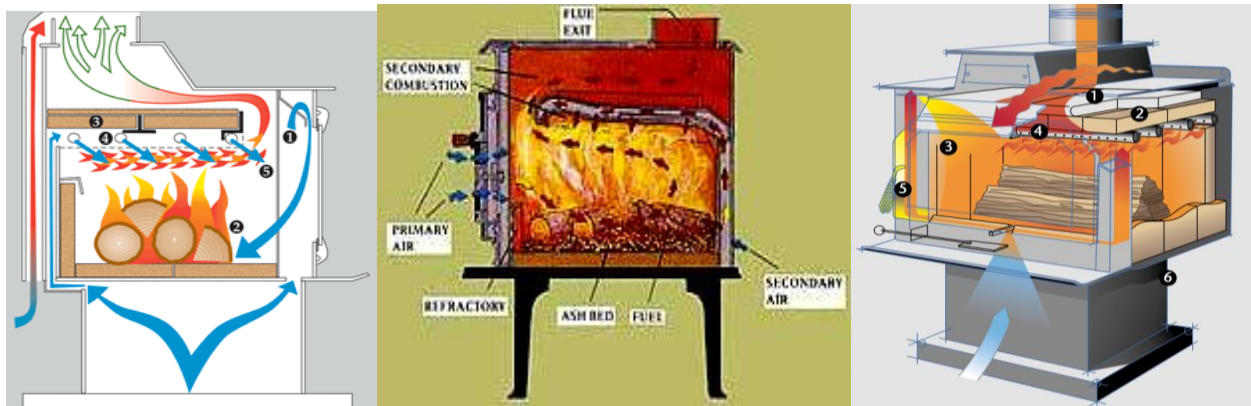

Figure 3: High efficiency non-catalytic wood stove models [7]

*Catalytic stoves* are equipped with honeycomb catalytic reactors in which complete combustion of wood pyrolysis products takes place resulting heat and emissions containing carbon dioxide CO<sub>2</sub> and water H<sub>2</sub>O, the minimum possible air pollutants (see Figure 4).

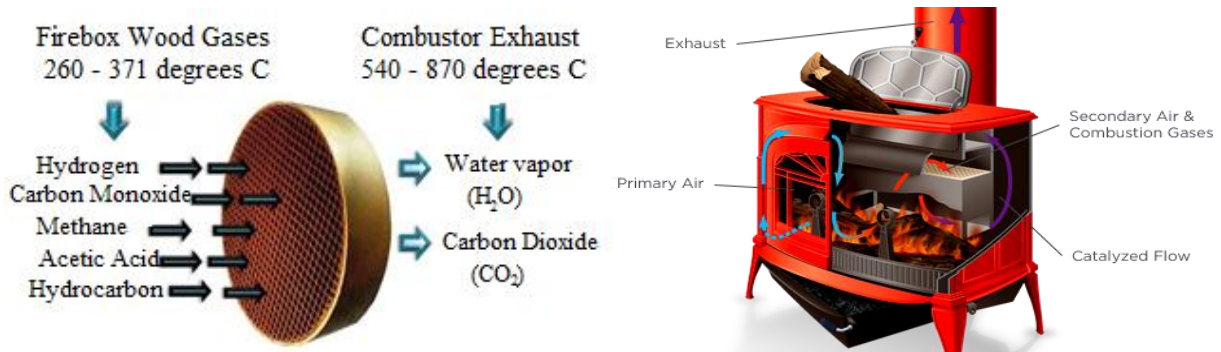

Figure 4: Operation of the catalytic reactor [8]    Figure 5: Catalytic wood stove model [9]

Figure 5 shows a high efficiency catalytic stove model.

Figure 6 shows a hybrid high efficiency stove model that produces both an additional combustion of the pyrolysis products at the upper part of the furnace and a passage through a catalytic reactor of the gases resulting from the primary and secondary combustion.

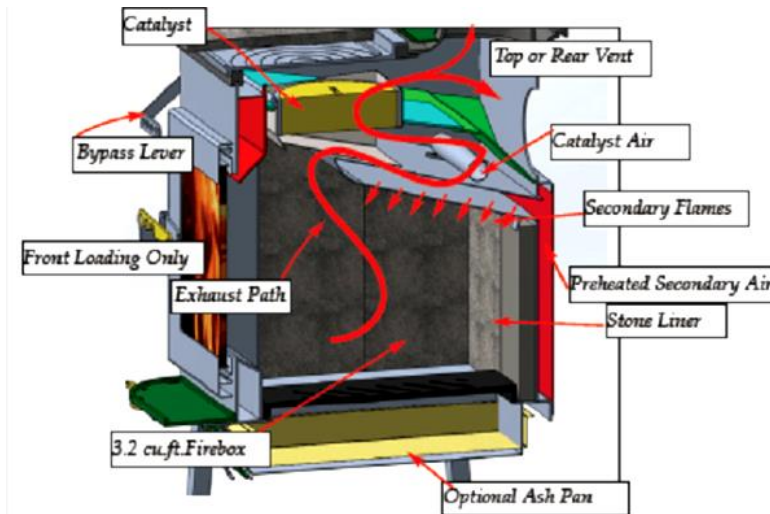

Figure 6: High efficiency hybrid stove model [10]

#### 4. CONCLUSIONS

In the paper are first presented general considerations about wood burning, then the principles of operation and the constructive structures of modern stoves with high efficiency, highlighting the benefits of their use in terms of both thermal efficiency and pollutants emission reductions in the atmosphere.

Then, several representative models of non-catalytic and catalytic high-efficiency wood burning stoves are reviewed.

The problem of introducing and using modern, high efficiency wood stoves is also extremely important for our country because in rural areas the production of thermal energy for heating households is made mainly using wood stoves.

#### References

- [1] Diaconu-Şotropa, D., Burlacu, L., *Burning phenomena*, Review AICPS no. 1/2007, Bucharest, 2007.
- [2] Mădărăşan, T., *Fuels combustion*, course support <http://www.termo.utcluj.ro/termo/06ardere.pdf>
- [3] Cubleşan, V., *Fighting processing to solid fuel materials in the field of thickness*, doctoral thesis, U.T.C.B., Bucharest, 2011.
- [4] \*\*\**Burning of wood*, <http://virtual.vtt.fi/virtual/innofirewood/stateoftheart/database/burning/burning.html>
- [5] \*\*\**Choosing the Right Wood Stove*, <https://www.epa.gov/burnwise/choosing-right-wood-stove#emission-limits>
- [6] \*\*\* *List of EPA Certified Wood Stoves*, <https://www.epa.gov/compliance/list-epa-certified-wood-stoves>
- [7] \*\*\* *Canyon™ ST310 Iron Strike Stove*, <https://woodstoves.net/ironstrike/canyon-st310-wood-stove.html>
- [8] \*\*\* *FIRECAT™*, <http://firecatcombustors.blogspot.ro/2013/02/here-is-how-catalytic-combustor-works.html>
- [9] \*\*\* *Catalytic vs Non-Catalytic Wood Stoves: What's right for you?*, <http://www.alsips.ca/catalytic-vs-non-catalytic-wood-stoves-whats-right-for-you/>
- [10] \*\*\* *Wood Stove Decathlon*, <https://instead.com/blog/wood-stove-decathlon>

# ELECTRO-HYDRAULIC STAND FOR TESTING RELIABILITY OF SPECIAL MATERIALS

Ioan-Alexandru SĂRĂCIN<sup>1\*</sup>, Iulian-Claudiu DUȚU<sup>1</sup>, Gheorghe VOICU<sup>1</sup>

<sup>1</sup> Biotechnical Systems Department, University Politehnica of Bucharest, no.313 Splaiul Independenței, 060042, Bucharest, Romania

\*E-mail of corresponding author: [saracin.alex@gmail.com](mailto:saracin.alex@gmail.com)

## ABSTRACT

The paper investigates the possibilities and the technical manner in which it can be realized, as a functional model, an electro-hydraulic stand for testing the reliability of some special materials, used for example in manufacturing dental drills, in the process of machining noble or non-noble metals, without taking into consideration the use and the reliability of the mechanical components.

## 1. INTRODUCTION

The electro-hydraulic testing stand that the authors propose here, which is shown in the figure 1, it is considered to be useful for testing noble or non-noble materials, having well known mechanical properties or yet unknown, in order to be used in technical fields such as mechanical engineering [3], [4], [5], dental medicine, orthopedics and other related fields. The stand must simulate rotary and translational motion of tested samples.

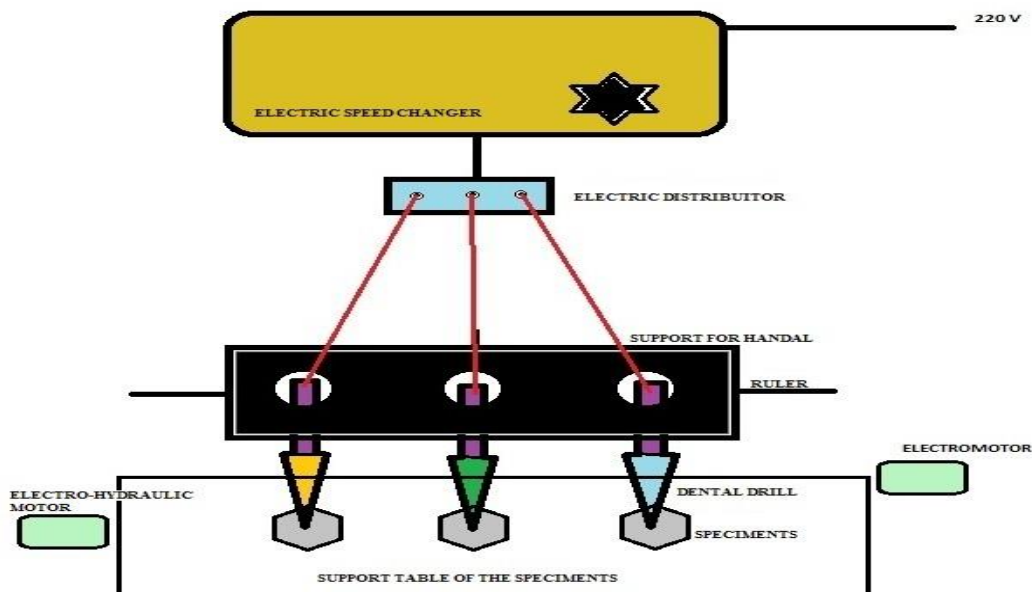

Fig. 1. Brief schematic of the electro-hydraulic testing stand

By following the structure of an industrial system, there are many simplified subsystems whose components are in relative movement of sliding, rolling, pivoting or combinations of them subjected to tribological stresses. Tribologically required materials may cause damage caused by contact deformation (Hertz's theory), friction and wear.

The essential functions of the mechanical systems with relative contact surfaces in relative motion and corresponding tribological examples (DIN 50.323) are:

- transmission of motion (bearings);



- braking of the movement (brakes);
- power and energy transmission;
- information transmission
- materials transportation;
- rail and road transport;
- mechanical machining by cutting.

Friction (as well as wear) is not a material but is a system property, the size of which depends on many parameters. The coefficients of friction of certain pairs of materials must be determined experimentally indicating in advance the parameters of the tribological system in accordance with the research rules (e.g DIN50320, SR ISO 7148/1, SR ISO/TR — 7147, STAS 10293-83, STAS 8069-87, STAS 8618-79 and the recommendations of ISO 9000 quality standards). The process of friction between surfaces in contact with the elements of the system results in: the loss of energy manifested by the heat produced and wear. Wear is the continuous loss of material from the surface of an element, due to mechanical causes, meaning relative and relative drag relative to another solid, liquid or gaseous element (tribological demand DIN 50320).

In contradistinction to the resistance properties that are characteristic of the material, the wear occurring at tribological stress results from the contribution of all components of a technical system involved in the wear process, it can only be described with "system specific" wear characteristics. Loss of material leads to changes in the dimensions and shape of the contact surfaces. Under certain temperature conditions, structural changes of superficial layers may occur simultaneously, which may lead to the formation of superficial layers with specific characteristics (it is possible to modify the fine structure of the surface in contact due to the destruction).

To study and elucidation of phenomena occurring during wear of metal surfaces in contact in relative movement have proposed various systems for classifying types of wear, in relation to the processes that take place during the friction of solid surfaces, observed in practice about the appearance and the degree of deterioration. German Standard DIN 50320 has a model that can be used to characterize different types of wear depending on the factors that determine the initiation and development of the wear process. Correspondingly to this general presentation, wear processes are essentially influenced by the following set of parameters:

- the set of request conditions, composed of the type of motion or motion kinematics (slip, roll or run, crash or strike, flow), the evolution of the movement in time (continuous, oscillating, intermittent), the characteristics of the request (load, speed, temperature, duration of request);
- the structure of the tribological system, specifying the components involved in the wear process (casing 1, spindle 2, lubricant 3, environment 4), properties of the elements (the properties of the material, the shape of the elements), tribological interactions between system elements (contact status, type of friction, wear mechanisms).

In the case of friction wear of solids, practice shows that any movement or relative movement of two bodies in contact is accompanied by strong forces or couples determined by the physical nature of the contact areas located on the two bodies. These resistances have received the general name of "friction". In rest, they have a variable magnification up to a certain limit, after which the relieving motion of the bodies is brought into contact. In a first approximation, the limit value of the resistances is proportional to the normal reaction in the contact area considered. After starting the relative movement of the two bodies, the value of the resistors can be considered, also in a first approximation constant and equal to the maximum value in the resting state. These states of experimental nature have as a first physical explanation that the contact areas of the two bodies in contact are harsh and deformable rather than stiff and rigid. So friction is a physical phenomenon that can be represented by a system of forces that

oppose the relative movement or relative movement of two bodies in contact. This results in sliding friction and rolling friction of solid bodies leading to material wear, loss of material or even damage to technical systems.

When studying sliding friction, let consider two bodies in contact  $C_1$  and  $C_2$ . The reaction force in the contact point has normal and tangential components. If the tangential component exceeds a certain limit, there is a relative movement between the two bodies and the friction then bears the name of the dynamic slip friction. The tangential component in this case bears the name of the dynamic friction force (STAS 1814-83), and its effect is to slow the motion of one of the bodies relative to the other. At the contact on an area (surface) reaction  $R$  of the area is inclined with an angle  $\varphi$  to the normal at the surface: component  $T = R |\sin \varphi|$  of the reaction balance the  $F$  component of the resultant external forces (active) applied to the body, being equal and directly opposite to it. This is the adhesion friction and its upper limit (equal to the lowest value  $\bar{F}$  for which the body  $C_1$  opposes the movement of the body  $C_2$ ) is equal to the dynamic slip rub at the beginning of the slip. Angle  $\varphi$  is called friction angle. Its value when the body  $C_1$  is on the point of slipping on the contact surface (equilibrium at the limit) is called the friction limit angle (for metals  $\varphi < 10^\circ$ ).

The cone having the peak in the contact point considered as a normal axis at this point, and the tip at the top  $\varphi$  is called a friction cone. Friction is a complex physical-mechanical phenomenon and the laws are established experimentally for each couple of bodies in contact, Coulomb's laws, experimentally established at the end of the eighteenth century, can be summed up as follows:

- a. maximum friction force is directly proportional to the normal  $N$  reaction modulus; the proportionality coefficient bears the name of the coefficient of friction;
- b. static slip coefficient (adhesion coefficient)  $\mu_0$ ;  $\varphi_0$  is determined using the relation:

$$\mu_0 \leq \frac{|\bar{T}|}{|\bar{N}|} \quad (1)$$

- c. dynamic slip coefficient  $\mu$  is determined using the formula:

$$\mu = \frac{|\bar{T}|}{|\bar{N}|} \quad (2)$$

where  $\bar{T}$  is the frictional force, and  $\bar{N}$  is the normal force.

- d. maximum sliding friction force does not depend on the size of the surfaces in contact;
- e. maximum slippage force depends on the nature of the bodies in contact;
- f. slippage friction force is independent of the relative sliding speed of the two bodies in contact.

Given the above, there can be made some critical remarks on Coulomb's laws, as follows:

- a. the proportionality of the friction force with the normal reaction is true only for not too high values of  $\bar{N}$ ; for higher  $\bar{N}$  values the friction increases faster than with the first power;
- b. the coefficient of friction is dependent on speed. The friction force generally decreases as the speed increases. An experimental formula for calculating the coefficient of slip friction is:

$$\mu = (a + bv)e^{-cv} + d \quad (3)$$

where  $a$ ,  $b$ ,  $c$ , and  $d$  are constants, which are determined experimentally,  $v$  is the slip rate and is based on natural logarithms;

- c. coefficient of friction depends on the quality of the surfaces in contact with the two bodies. This conclusion is valid only up to a certain level of quality of surfaces; if they are very finely processed there are forces of attraction between the molecules of the two bodies in contact and the coefficient of friction increases again;
- d. size of the surfaces in contact as well as the pressure between them does not have precise influences;
- e. value of the friction coefficient is lower as the temperature of the contact area is higher; the explanation is that the asperities of the surfaces in contact become softer, thus opposing a lower resistance;
- f. surfaces that stay for a long time in contact with each other travel relatively more weight than if they are not left in contact for a long time. This phenomenon is explained by the interpenetration asperities in contact and the physic-chemical changes of the surface superficial layers in contact. An experimental equation showing this addiction is given by:

$$\mu = \mu_{\infty} e^{-nt} (\mu_{\infty} - \mu_0) \quad (4)$$

where  $t$  is the pressing time,  $\mu_0$  the static slippage coefficient at  $t = 0$ ,  $\mu_{\infty}$  the dynamic slippage coefficient at  $t = \infty$  (asymmetric value) and  $n$  is a constant to be determined experimentally;

- g. the coefficient of slippage friction (static and dynamic) depends very much on the conditions in which the experiment took place;
- h. in the case of point contact between the two bodies to move in different directions passing through the point of contact there are different coefficients of sliding friction; this case is called anisotropic sliding friction, characteristic of anisotropic bodies.

The coefficient of slippage friction reaches its extreme values in the two directions  $\mu_1$  and  $\mu_2$  and referred to as the main directions of the considered point friction and resultant support of the friction force in the contact point does not coincide with the movement of the point holder. Thus appear the tensor character of the slip friction coefficient in the anisotropic friction occurs.

## 2. METHODOLOGY

The authors propose in this paper an electro-hydraulic testing stand, having the diagram presented in Fig. 1.

The electro-hydraulic testing stand will be equipped with an electric drive used to vary rotational speed from 3000 to 30 000 rpm, a mechanical support used to fix the handles of two electric motors, an electric speed changer, an electric distributor and a support table for tested samples of materials to be studied. On the testing stand there will be also mounted hydraulic motor used for generating the rotation movement of the tested samples and one linear hydraulic motor (cylinder) in order to obtain a linear movement for the samples' support table. The mechanical support for the samples themselves has the possibility to move in vertical plane having attached a few additional weights used to provide a certain value for the pressing force on each sample.

Operation of the stand is considered to be simple and it is described in the following. After making the test samples according to the validation standards, measurements are taken and their weighing is carried out. The type of cutters to be used for determinations shall be determined, weighted and photographed at a macro level at a scale of 100: 1, and then mounted in the handles and inserted into the mandrels of the handles. Measured and weighed samples are mounted on the support table where the sample clamping chucks are provided to ensure the

rotation movement. After that, there is performed an adjustment of the force of the cutters on the specimens and place the appropriate notches on the mandrels of the handles.

Afterwards, time is set for the test, in this way it is determined the speed at which the cutters will work. The next step is to set the samples' speed and displacement speed and travel of the support table of samples.

After the test time has elapsed, measurements of the dimensions and weighing of both the samples and the cutters will be carried out. At the same time, the chips resulting from the samples will be collected and the size of these will be determined, this being influenced by the speed of the drills and the travel of the samples table.

The experimental results will be noted in a table, as presented in Table 1.

Table 1. Experimental results

Test no.	Drill type	Sample material	Test time [min]	Drill speed [rpm]	Sample speed [rpm]	Table speed [ $\text{ms}^{-1}$ ]	Pressing force [N]	Chip size [aspect]
1	Super-Tech (Co-Cr)	Heraenium CE*	15	30000	2	$10^{-3}$	$3 \cdot 10^{-4}$	superfine
	Super-Tech (Co-Cr)	Gialloy PA**	15	30000	2	$10^{-3}$	$3 \cdot 10^{-4}$	extrafine
	Super-Tech (Co-Cr)	Wirobond ***	15	30000	2	$10^{-3}$	$3 \cdot 10^{-4}$	fine
2	MILLI-MICRON (Co-Cr)	Heraenium CE*	15	30000	2	$10^{-3}$	$3 \cdot 10^{-4}$	superfine
	MILLI-MICRON (Co-Cr)	Gialloy PA**	15	30000	2	$10^{-3}$	$3 \cdot 10^{-4}$	extrafine
	MILLI-MICRON (Co-Cr)	Wirobond ***	15	30000	2	$10^{-3}$	$3 \cdot 10^{-4}$	fine
3	Tittano (Ti)	Heraenium CE*	15	30000	2	$10^{-3}$	$3 \cdot 10^{-4}$	superfine
	Tittano (Ti)	Gialloy PA**	15	30000	2	$10^{-3}$	$3 \cdot 10^{-4}$	extrafine
	Tittano (Ti)	Wirobond ***	15	30000	2	$10^{-3}$	$3 \cdot 10^{-4}$	fine

\*Co 63,5%, Cr 27,8%,W 10% Mo 6,6 %, Si 1%, Mn 0,6%

Aliaj Cr-Co indicat pentru realizarea protezelor scheletizate. • Densitate 8,0 g/cm<sup>3</sup> • Duritate 380 HV10 • Interval de topire: 1330°C-1380°C • Temperatură de turnare 1530 °C

\*\*Cr 30,1%, Co 61,5%, Mo 5,5 %, Si 1,0%, C 0,6%

Aliaj Cr-Co indicat pentru realizarea protezelor scheletizate. • Duritate 460HV10 • Densitate 8,25 g/cm<sup>3</sup> • Interval de topire: 1320oC-1380oC

\*\*\*Co 63.3%, Cr 24,8%, Mo 5.1% W 5,3%

Aliaj Cr-Co indicat pentru realizarea coronei si punti metalo-ceramice.Duritate 310 HV010 Interval De topire 1370-1420 C

Based on the results in the sample table above, there will be determined the mechanical wear degree of the samples and of the drills, during testing, taking into account the rotational speed, the translational speed and the pressing force.

### 3. CONCLUSIONS

- The testing stand that the authors propose in this paper is relatively simple and can be constructed using devices and equipment available on the current market. In some cases, some small modifications are needed, that are going to be performed on specialized electro-mechanical workshops.
- Using the stand, it can easily be determined several mechanical properties of tested materials.
- It was intended to obtain a testing stand that is easy to use and do not need highly trained personnel to operate.

### References

- [1] Croitoru, Gh., Rusu, I., Carbon nanotube/cement composites, International Scientific Conference ULGALMAT, 2009.
- [2] Țuculina, M., Lucrări practice de odontoterapie, Ed. Medicală Universitară, Craiova, 2009.
- [3] Mitar, P., Alumina powder properties obtained by neutralization process of sodium aluminate, International Scientific Conference ULGALMAT, 2009.
- [4] Potecașu, O., The assessing of mechanical characteristic of the steels, International Scientific Conference ULGALMAT, 2009.
- [5] Sărăcin, I., Mecanica și rezistența materialelor, Ed. AIUS, Craiova, 2007.

# AIR QUALITY MONITORING FOR BAKERY UNITS

Simion Gabriela Cristina<sup>1</sup>, Duțu Mihaela Florentina  
University Politehnica of Bucharest / Romania

## ABSTRACT

This paper assess the effect of exposure to flour dust on respiratory symptoms and lung function of bakeries workers. Workers protection and a good quality of air is realized if there are good systems of ventilation and vacuum cleaner.

## 1. INTRODUCTION

The bakery industry occupies an important place in the production of romanian consumer goods, primarily because bread is a basic food that is consumed daily.

Pollution is the contamination of the environment with materials that interfere with human health, the quality of life or the natural function of ecosystems. Pollutants from the working environment may be gaseous or particulate solids or liquids in suspension, generically called aerosol.

The food industry and especially the milling and bakery industries pollute air with dust resulting from the grinding of the cereals and flour manipulation and the odorous gases resulting from the fermentation of the products of vegetable origin. A bread factory, pollutes air with dust, VOC - ethanol, acetaldehyde, esters, acids.

## 2. EXPOSURE TO FLOUR DUST AND WORKERS PROTECTION

In food industrial environments, the name of powder is the most widely used. Suspended powders in the industrial environment generally differ in size and effects on the human body in sedimentary and inhalable particles. Sedimentary powders are particulate sizes and densities that favor their deposition. Suspended powders are dust that remain in the air for a long time and are dispersed systems with a solid dispersion phase and gaseous dispersion medium. [10] These types of polydisperse systems in physics are called aerosols. Airborne dust is generally considered to be aerosolized, with diameters between 0.001 and 100 $\mu$ m and a mass between 9 and 10 g / m<sup>3</sup> of gas. One of most dangerous factor for health , in bakery industry is exposure to flour dust( particulates with diameters 1  $\mu$ m to 80  $\mu$ m).It is known to cause allergic rhinitis, occupation asthmas . Flour and grain dust acts as an irritant, it may provoke nasal and eye symptoms and it is the second most cited agents associated with occupational asthma [1].SCOEL (Scientific Committee on Occupational Exposure Level) concluded that exposures [dust]  $\leq$  1 mg / m<sup>3</sup> of inhalable flour powder would protect most workers.

Wheat flour is a complex organic dust with a large diversity of antigenic or allergic components [3]. The antigens involved can be wheat flour proteins, flour parasites, silica, fungi, insects or technical additives such as enzymes [4]. Multiple allergens exist in the protein fraction of wheat flour that are responsible for respiratory dysfunctions and baker's asthma[5]. Wheat flour consists of water soluble albumins, salt-soluble globulins, gliadins and glutens. Albumins and globulins appear to be the most important proteins contributing to immediate hypersensitivity reactions to wheat proteins Flour dust is a hazardous substance; it

---

<sup>1</sup>Spl.Independentei, no.313, sect.6, Bucharest, 0214029637, gacsimion@gmail.com

is a respiratory sensitizer and is known to cause allergic rhinitis and occupational asthma among bakers and millers. Asthma arising from workplace exposure to cereal flour (bakers' asthma) is one of the commonest types of occupational asthma [5,6]. It is also an irritant and may give rise to short term respiratory, nasal and eye symptoms or it may provoke an asthmatic attack in individuals with pre-existing disease and also lead to chronic bronchitis. In addition, flour and / or grain mill workers have been reported to exhibit a variety of clinical manifestations including wheezing, febrile reactions, grain fever, lung fibrosis, allergic alveolitis, impairment of lung function and chronic obstructive pulmonary disease. In occupational respiratory disease, spirometry is one of the most important diagnostic tools. Measurement of dynamic lung functions is more important than of static lung volumes. Lung function tests are beneficial in the early recognition of pulmonary dysfunctions even if the workers may be normal clinically.

A study for exposure to flour dust in bakeries is made function of bakery size or on workers categorized by job grouping.

Table 1: Inhalable dust exposure for workers with different job[2]

Job category	Workers Number	Dust(mg/m <sup>3</sup> )		
		Median Value	Max Value	75th percentile
Baker/table/dough baker	108	3,6	47	7,1
Mixer/siever/weigher	59	5,2	30,6	9,7
Cleaner	6	4,4	14,3	10
Others	35	2,1	30,8	4,1

Table 2: Inhalable dust exposure for workers categorized by bakery size[2]

Bakery size (number of employes)	Number of bakeries	Dust(mg/m <sup>3</sup> )		
		Median Value	Max Value	75th percentile
Micro(1-9)	22	3	28,1	5,5
Small(10-49)	20	2,2	30,6	5,7
Medium(50-249)	6	5,2	47	10,4
Large(>250)	7	7,6	27,7	12

Bakery size is the major influencing factor on exposure level. Bakeries and individuals employ must have good working practices with correct use of local exhaust ventilation systems. Poor ventilation can be a major factor in the development of heart, lung, mental, as well as many threats to our health. The centralized evacuation mechanical system continuously evacuates the polluted air from rooms where much moisture is generated.

Thus, fresh air is passively introduced from the outside to the halls and rooms, thus creating a fresh, clean airflow across the entire location. The air circulates through the terminal units and the pipes hidden in the false ceiling to the central unit. The system is designed to be integrated into the construction to be hidden from view. The vast majority of systems in the market also have the 'boost' option to increase the ventilation process when necessary, for example, when the rhythm of the work is increased, when the furnace is used to the maximum.

The main features and advantages of a mechanical ventilation system are:

- Compact units that can be easily mounted and disguised

- Low power consumption
- High Energy Efficiency Levels (EC "Electronically Commutated")
- Low noise level
- Can be used with 204 x 60mm or 110 x 54mm tubing
- The central unit can be cleaned and repaired without disturbing the pipeline routes
- Sneaky grip.

The industrial dust aspirator (figure1) is a mobile plant for cleaning and air intake together with the impurities used under the pressure produced in the suction unit.[7] The suction air is cleaned in dusting systems and pushed out of the vacuum cleaner. The amounts of impurities to be removed are often large and differentiated from the point of view of the concentration and the functional composition.

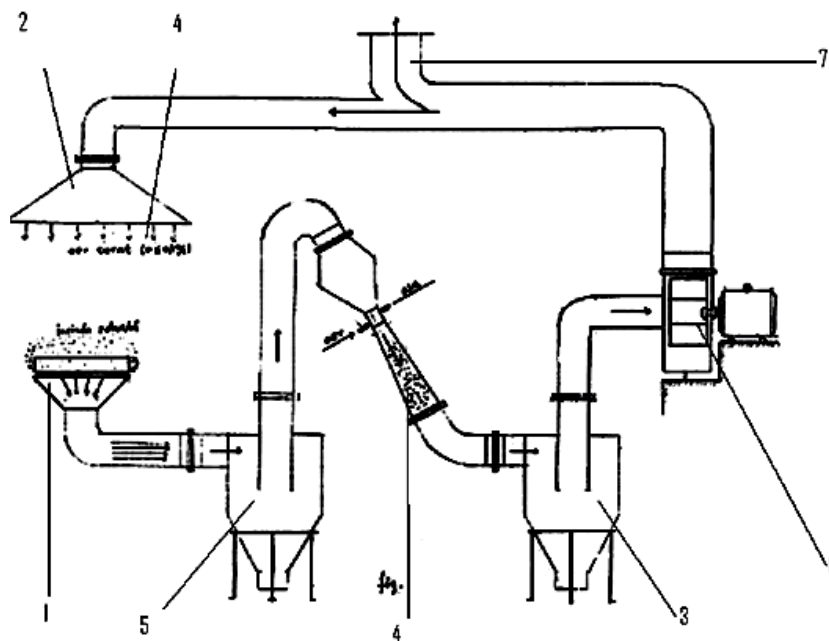

Figure 1: Vacuum cleaner for industrial dust

1 - polluted enclosure; 2 - suction hood; 3 - primary cyclone; 4 - humid enclosure; 5 - secondary cyclone; 6 - fan; 7 - discharge pipe outwards; 8 - discharge hood inside.

For the vacuum cleaner to work well, it must be characterized by sufficient size of under pressure and air flow , easy handling of the installation in full respect of labor protection and the possibility of dust-free emptying of preliminary separators and dust tanks.

### 3. CONCLUSIONS

Studies have shown that exposure to flour dust is associated with development of respiratory symptoms and varying degree of reduction in lung function. Flour dust is an asthmagen and is known to cause sensitization, allergic rhinitis and occupational asthma amongst bakers and millers. We consider indoor air pollution in the bakeries with regard to temperature and relative humidity and a vacuum cleaner is used for improving quality of air.



## References

- [1]. Ross DJ, Keynes HL, McDonald JC (1997) Surveillance of work related and occupational respiratory in UK, *Occup. Med.* 47:377-81.
- [2]. Elms J., Robinson E., Rahman S., Garrod A. Exposure to flour dust in UK: Current Use of Control Measures, *Occup. Med.* 49 No 1 pp 85-91 (2005).
- [3] E. Zuskin, B. Kanceljak, E.N. Schachter, J. Godnic-Cvar, J. Mustabegovic, A. Budak, Respiratory function and immunological status in cocoa and flour processing workers, *Am. J. Ind. Med.* 33 (1) (1998) 24–32.
- [4] M.N. Kolopp-Sarda, N. Massin, B. Gobert, et al, Humoral immune responses of workers occupationally exposed to wheat flour, *Am. J. Ind. Med.* 26 (1994) 671–679.
- [5] A.S. Tatham, P.R. Shewry, Allergens to wheat and related cereals, *Clin. Exp. Allergy* 38 (2008) 1712–1726. exposure, *Occup. Med.* 49 (1999) 237–241.
- [6] P. Maestrelli, P. Boschetto, L.M. Fabbri, C.E. Mapp, Mechanisms of occupational asthma, *J. Allergy Clin. Immunol.* 123 (2009) 531–542.
- [7] M.S. Dykewicz, Occupational asthma: current concepts in pathogenesis, diagnosis, and management, *J. Allergy Clin. Immunol.* 123 (2009) 519–528.

# NOISE MEASUREMENT AND DIRECTIONAL CURVE DETERMINATION FOR AN PORTABLE POWER GENERATOR

Cristian Sorică<sup>1)</sup>, Elena Sorică<sup>1)</sup>, Andreea Iulia Grigore<sup>1)</sup> Marius Remus Oprescu<sup>1)</sup>

<sup>1)</sup>National Institute of Research - Development for Machines and Installations Designed to Agriculture and Food Industry - INMA, Bucharest, Romania, [postelnicu.elena@yahoo.com](mailto:postelnicu.elena@yahoo.com)

**Keywords:** *acoustic pressure, acoustic power level, directional curve, portable power generator*

## ABSTRACT

Noise is a complex of different sounds and frequencies and different intensity overlapping randomly. A low level of acoustic pollution leads to the environmental and consumer health protection satisfaction level and thus increases the quality of marketed products. 2000/14/E Directive it requires manufacturers to apply to each equipment introduced on market the guaranteed value of the acoustic power.

In this regard, the paper consists of measuring the acoustic power level of an electric current generator as well as the measurement of the acoustic pressure level in order to highlight the noise propagation directions.

Also, in the paper will be specified choosing the method, number of the used microphones, calculating the average of the acoustic pressure, functioning conditions, and measurement uncertainty.

## 1. INTRODUCTION

2000/14/EC directive belongs to improving air quality category and is part of the chapter- "Air quality, targeting emissions management outside buildings". Air quality is an environment priority issue and any kind of is recorded in regulations.

2000/14/CE directive establishes provisions (noise limits, public information regarding to noises produced by equipment, conformity assessment procedures etc.) related to equipment sound emissions for using outside the buildings. The directive follows in a general manner the principles and concepts of the modules for different conformity assessment procedures stages and rules, applying EC con-formity marking [1].

The equipment subjected to the provisions and regulations of 2000/14/EC directive are set out in art. 12 and 13 of this Directive:

- equipment subjected to noise limitations;
- equipment not subjected to noise limitations, only marking of this level. [2]

Under the 2000/14/EC directive, a number of technical equipments are summarized, subjected to limitation or marking sound power level, which include portable power generators for domestic purposes to supply electricity at places where electricity grid does not exist or where a temporarily electricity cut off is present.

According to the directive, power generators with electric power  $<400$  kW are subjected to sound level limitations and electric power generators  $\geq 400$  kW are only subjected to noise marking. [1]

In order to determine the directional curves, the sound pressure level will be measured in 12 points equidistant in the horizontal plane, on a circle (at 30 degrees angles).

## 2. MATERIAL AND METHOD

*The sound pressure level* represents the pressure of the waves with which the sound moves in an environment and we can say that is what the human ear perceives as sound. The unit of sound pressure is (dB), the human ear perceiving values above 0 dB (audibility limit) and up to 120dB (the value at which sound produces physical pain). [10]

The sound power level of a noise source is determined using *acoustic pressure* ( $p$ ). This represents a fluctuating pressure due to the presence of sound presence overlapped on the static pressure and is expressed in Pascals (Pa).

*Sound pressure level* ( $L_p$ ) is ten times the logarithm to the base 10 of the ratio between the square of the measured sound pressure and the square of the reference sound pressure (20  $\mu$ Pa).

*Sound pressure level averaged over the measurement surface* is given by: [3]

$$\overline{L'_p} = 10 \lg \left( \frac{1}{N} \sum_{i=1}^N 10^{0.1 L'_{pi}} \right), [\text{dB}] \quad (1)$$

where  $N$  is the number of measuring points;

$L'_{pi}$  - sound pressure level measured in the  $i$  position of the microphone

*Sound pressure level averaged over the measurement surface and corrected is:*

$$\overline{L_{pf}} = \overline{L'_p} - k_1 - k_2 \quad (2)$$

where  $k_1$  - is the correction for background noise;

$k_2$  - the correction for the reflected sound (it applies to enclosed spaces).

*The sound power level is given by:*

$$L_w = \overline{L_{pf}} + 10 \lg \left( \frac{S}{S_0} \right), [\text{dB}] \quad (3)$$

where  $S$  is the measurement surface area;

$S_0 = 1 \text{ m}^2$ . [3], [7]

In view of determining the acoustic power level it is used a modern equipment that in fact measures the acoustic pressure on measuring surface, makes the necessary corrections and then calculates the acoustic power level by the above formula. [4]

The researches to determine the sound power level were performed on a Power Generator R-Power GE 2500 S (Fig. 1) with the power of 2.5 kW, subjected to limitation of noise because the power is less than 400 kW.



**Fig. 1** – Power Generator R-Power GE 2500 S

In table no. 1 are presented the measuring devices used:

**Table 1**

No.	Name of instrument or device	Measuring range	Measurement uncertainty/ Permissible error
1.	Measuring roulette	0÷8 m	$\pm 0,5 \cdot 10^{-4} \text{ mm}$
2.	Integrating Sound Level Meter type 2237	20÷20000 Hz	0,3 dB
3.	Anemometer Testovent 4000 type	0,4÷40m/s	measurement uncertainty 0,35m/s
4.	Thermohygrometer DH 50	humidity: 5÷95% temperature: - 20÷80°C	$\pm 0,1 \%$ measurement uncertainty 0,5°C

Figure 2 shows the *anemometer Testovent 4000 type* used to measure wind speed, while Figure 3 shows *thermohygrometer DH 50*, used for measuring air temperature and humidity:



**Fig. 2** - Anemometer Testovent 4000 type [8] **Fig. 3** – Digital thermohygrometer DH 50

The equipment used to determine the sound power level is a measurement and analysis system based on PC - "System Type 3569 C PULSE multi-analysis" produced by Bruel & Kjaer, which consists in 12 microphones with preamp, amplifier and signal conditioning module with 12 measuring channels, assisted by a notebook computer and software required for the acquisition, processing, interpretation and presentation of data in tabular form. [5] Also, includes a calibration module type 4231 which generates on the frequency of 1 kHz, a noise level of 94 dB or 114 dB. The calibration value of 114 dB is used when measurements are made in a noisy environment (noise level > 50 dB). [6]

Calibration of measuring channels is performed at the beginning of each set of measurements required to measure a noise source. In order to do that, one must first activate the calibration program, that will automatically sense the presence of the microphone calibrator connected to the PULSE system measurement channels. When the calibrator is detected, the required correction is performed to the amplification channel and then, the calibrator is searched on other microphones connected at the system and the procedure repeats again.

After the last measurement channel calibration, the calibration program is closed and the data acquisition program is opened, according to the number of measuring channels. After its execution, we need to run another program that takes the data from the previous one and processes them according to SR EN ISO 3744 which refers to the determination of sound power levels of noise sources using sound pressure.

In order to determine the sound power level, the following operations were performed, necessary for preparing the product for tests:

- measuring the noise source dimensions;
- calculating the surface area;

According to 2000/14/EC directive up to 12 microphones may be used to determine the sound power level using hemispherical measurement surface or up to 9 microphones for parallelepiped surface measurement. The number of the microphones may be reduced to six, but positions 2, 4, 6, 8, 10 and 12 are mandatory in all cases, as required by clause 7.4.2 of EN ISO 3744:2010. [2]

In this case we used six microphones (2, 4, 6, 8, 10, 12) positioned on a hemispherical measurement surface (Fig. 2) according to D 2000/14/EC directive. [7]

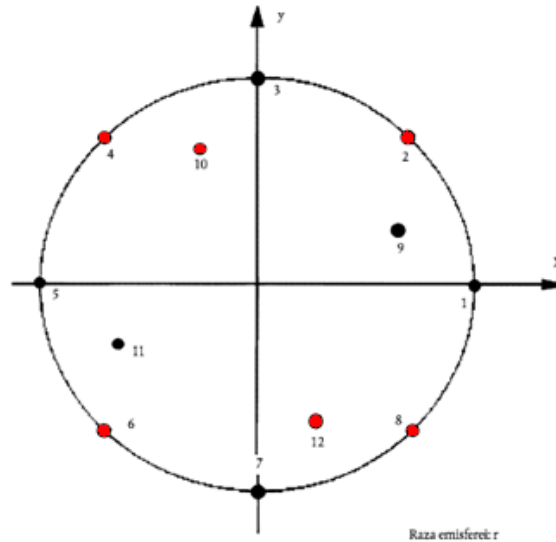

**Fig. 2** - Microphone positions for hemispherical measurement surface with 6 microphones [7]

In order to determine the *directional curves*, 3 sets of records will be performed in 12 measuring points simultaneously with the PULSE type 3560 system. (fig. 3).

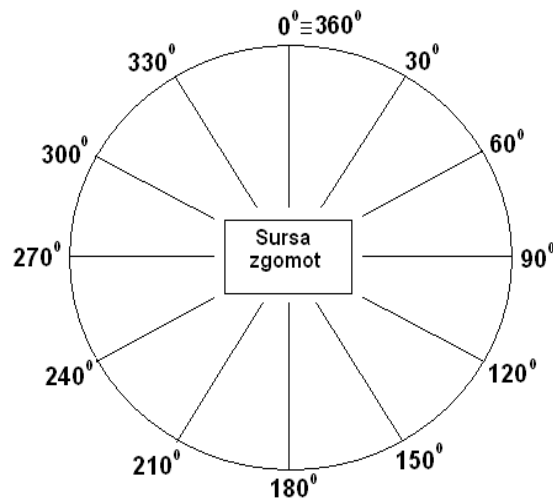

**Fig. 3** – Location of the measurement points

The purpose of the determination is to highlight the noise propagation directions by measuring the acoustic pressure in the 12 points placed equidistant in the horizontal plane on a circle (at 30 degrees angles) having in the center the noise source and radius “r” (chosen to cover the technical equipment inside the circle) arranged at the level “h” of the main noise source.

### 3. RESULTS

#### Weather conditions:

- temperature: 16,7°C;
- humidity: 52.6%;
- wind speed: 0.8 m/s

In table 2 are presented acoustic pressure level for every microphone and acoustic power level, in accordance with EN ISO 3744:2010:

**Table 2**

Sample	L <sub>p1</sub> [dB]	L <sub>p2</sub> [dB]	L <sub>p3</sub> [dB]	L <sub>p4</sub> [dB]	L <sub>p5</sub> [dB]	L <sub>p6</sub> [dB]	Average acoustic pressure level per sample [dB]	Acoustic power level L <sub>w</sub> [dB]	Average acoustic power level [dB]
Sample 1	80,3	78,6	78,4	80,7	80,1	81,4	80,05	94,1	<b>94,3</b>
Sample 2	80,3	78,7	78,3	80,8	80,2	81,5	80,11	94,1	
Sample 3	80,7	79	78,8	81	80,6	81,8	80,45	94,5	

L<sub>p1</sub>, L<sub>p2</sub>, L<sub>p3</sub>, L<sub>p4</sub>, L<sub>p5</sub> si L<sub>p6</sub> - represent the determined sound pressure level in each of the 6 measurement points in Fig. 2.

L<sub>w</sub> – represents the sound power level that is calculated by the PULSE system using the formula (Eq. 3)

$$L_w = 94 \pm 0.38 \text{ dB};$$

The assigned uncertainty is the expanded uncertainty obtained by multiplying the standard uncertainty with the expansion factor  $k = 2$  and was estimated according to GUM.[9]

Table 3 presents the sound pressure level measured simultaneously in the 12 points at the distance  $d=1\text{m}$  and height  $h=0.2\text{m}$ :

**Tabelul nr. 3**

Measuring angle [degrees]		0°	30°	60°	90°	120°	150°	180°	210°	240°	270°	300°	330°
Background noise [dB (A)]		<b>47.28</b>											
Sound Pressure level [dB (A)]	Sample 1	87.7	88.8	87.8	88.5	88.2	87.4	86.5	86.1	87.9	89.5	88.3	87.7
	Sample 2	87.8	89	88.1	88.8	88.8	87.8	86.7	86.4	88.5	90.1	88.4	87.7
	Sample 3	87.9	89.1	88.3	89.1	88.9	88.2	86.8	86.5	88.8	90	88.5	87.8
Average of the measured values		87.8	88.9	88.1	88.8	88.6	87.8	86.7	86.3	88.4	89.9	88.4	87.3

Based on the results obtained above, figure 4 shows the directivity curve of the Power Generator R-Power GE 2500 S, at a distance of 1 m from the main noise source:

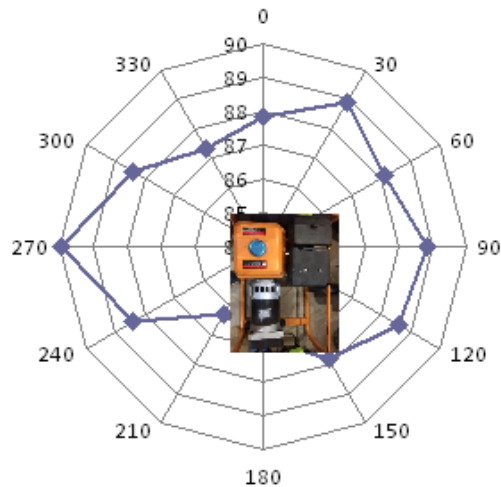

**Fig. 4** Determination of the directivity curve of the Power Generator R-Power GE 2500 S

## CONCLUSIONS

According to the 2000/14/EC Directive, the power generators with electric power <400 kW are subjected to sound level limitations and the power generators with electric power  $\geq 400$  kW are only subjected to noise marking.

The noise level emitted by the R-Power GE 2500 S Generator, which was subjected to the test, as set out in Directive 2000/14 / EC, is 94 dB, falls within the required limits and may be labeled accordingly.

Although the directivity curve does not have a special meaning for the end-user, it can still be very useful for the maker of such equipment, providing relevant information to improve the product throughout the production cycle to permanently improve its quality and functionality.

## References

- [1] Directive 2000/14/EC of the European Parliament and of the Council of 8 May 2000 on the approximation of the laws of the Member States relating to the noise emission in the environment by equipment for use outdoors, Official Journal. L 162 (2000) 0001-0078;
- [2] V. Vladuț, S. Biriș, S. Bungescu, At. Atanasov, D. Gafițianu, *Analysis of the methods and regulations in force, harmonized with EU legislation regarding the noise emission of equipment with outdoor operation*, INMATEH. I (2006) 143-152;
- [3] SR EN ISO 3744:2011 - Acoustics. Determination of the acoustic power and energy levels for noise sources, using acoustic pressure. Technical methods of closed conditions of those of an empty field above a reflecting plane;
- [4] M. Ganga, S. Bajenaru, V. Vladut, S. Bungescu, Bikić S., Measurement equipment for the acoustic power level and the evaluation of the uncertainty of the measurement, INMATEH. I (2007) 20-25;
- [5] \*\*\* PULSE Multi-analyzer System Type 3560 – technical documentation;
- [6]. \*\*\* Sound Level Calibrator type 4231 – technical documentation;
- [7] Postelnicu E., Vladut V., Sorica C., Cardei P. and Grigore I. - *Analysis of the sound power level emitted by portable electric generators (outdoor powered equipment) depending on location and measuring surface*, Applied Mechanics and Materials, Vol. 430 (2013), pp 266-275, ISBN 978-3-03785-877-6;
- [8] Technical documentation - Anemometer Testovent 4000 type;
- [9] SR GUIDE ISO/CEI 98-3:2010 - The measuring uncertainty. Part 3: Guide for expression of uncertainty in measurement (GUM: 1995);
- [10] Munteanu R. T. - *Sunetul în sistemele de ventilație și calculul nivelului de zgomot*, Buletinul AGIR nr. 1/2011 ianuarie-martie.

# EFFECTS OF WHEAT SEEDS CHARACTERISTICS ON ROLLER MILLING PROCESS – a review

Mădălina-Elena ȘTEFAN<sup>1</sup>, Gheorghe VOICU, Gabriel-Alexandru CONSTANTIN, Mariana MUNTEANU, Mariana IONESCU

*University Politehnica of Bucharest, Faculty of Biotechnical Systems Engineering*

## ABSTRACT

Factors affecting the wheat flour milling process in a roller mill are: the design and operation of the roller mill (rolls speed, roll gap, roll disposition, differential, flutes profile), wheat variety and wheat physical and mechanical characteristics (shape and size of the seeds, mass, volume, moisture content, porosity, density, bulk density, resistance to crushing, hardness). The effects of wheat seeds characteristics are manifested by the particle size distribution as well as the compositional distribution of the grist (large particle are very rich in the coating, while the small particles are only endosperm). Knowing the factors that influence the milling process in the roller mills (operation of grinding rolls) allows the choice of the most suitable technological process and the most efficient working regime resulting in high productivity, high quality grist products and as well as significant savings in energy consumption.

Key words: characteristics, roller mill, wheat seeds, wheat flour, milling.

## 1. INTRODUCTION

The milling process aims to break the seeds and separate the endosperm from the other structural parts, namely germ and bran. The main purpose of the grinding process for wheat seeds is to achieve a maximum yield of white flour. Studies on the physical and mechanical properties of wheat and grist products are carried out by numerous researchers in order to obtain high yields and significant savings in energy consumption.

In the roller mills the grinding of cereal seeds is accomplished by the action of the compression and friction forces of the material between the two rolls in rotation motion. The surface of the grinding rolls may be smooth or fluted. Grinding rolls with fluted surface are used to fragment the seed and to remove the endosperm, and the smooth surface rolls have the role of reducing the size of the endosperm particles and turning them into fine flour particles. Thus, in the grinding process, it must take into account the difference in the structure of the main components of wheat seed (bran and endosperm). The endosperm is friable and easily milled, while the bran is more plastic.

The physical and mechanical characteristics of wheat seeds (seed shape and size, volume, moisture, porosity, density, bulk density, resistance to deformation, hardness, etc.) directly influence the crushing process in roller mills to transform them into flour. Thus, the geometrical characteristics of the flutes and their mutual position for the two milling rolls, the diameter and the speed of the rolls, are also influenced by the physical properties of the grinding material and thus also of the seeds, [1].

The wheat flour quality depends on the physical, chemical and mechanical characteristics of the wheat seeds in relation to the processing technologies and the constructional characteristics of the machinery.

<sup>1</sup>Splaiul Independentei, 313, District 6, Bucharest, Romania, 0726043472, stefanelenamadalina@gmail.com



The value of the working capacity and the extraction coefficient of the flour are determined by the grinding characteristics of the wheat seeds, which in turn are influenced by the physical and mechanical characteristics of the endosperm, [2].

## **2. PHYSICAL CHARACTERISTICS**

Shape, size, volumes, density, specific surface, humidity of seeds are important physical properties in analysis the behavior of grain during grinding process, including in roller mills, [3]. Knowing the main dimensions of the seeds, the shape and the mass of each wheat seed is important in the conditioning process (separation on the sieves; correct choice of the shapes and sizes of the separating machinery holes) and in calculating of the power required for the grinding, [4,5,6,7,8]. The seeds that are large in size contain a higher percentage of endosperm, so a higher extraction coefficient is obtained. During the grinding process with the roller mill, the working parameters of the rolls must be adjusted according to the seed size, [9]. When the seeds to be grinded are of very wide size, the small seeds passes through the milling rolls (the first pair of milling rolls) without being crushed or only partially crushed, thus requiring a further grinding process. If the seeds size do not varies widely (there is uniformity), then the seeds are ground uniformly, resulting in a flour extinction coefficient greater, [9,10].

The porosity of the seeds is mostly influenced by their shape and size. When the seeds have a uniform size, their porosity is higher than when the seeds do not have a uniform size. Seeds of small size occupies the spaces between the seeds of larger size, resulting the lower the porosity, [11].

The volume and density of each seed influences how the flutes of grinding rolls attack the seed in the grinding process and the number of shear points during grinding, [1]. The difference in density between grains and impurities allows the cleaning of the grains in the conditioning process and the specific mass difference between the anatomical components of the grains (endosperm, bran, germ) allows the cleaning in the technological processes of processing.

Higher density wheat seeds contain a higher percentage of endosperm, compared to smaller and less dense seeds. Therefore, from the higher weight seeds results a larger quantity of flour, as opposed to lower seeds weight, [12].

The influence of the geometrical sizes, volume and mass of the seeds is manifested mainly on the working process of the grinding rolls of the mill, thus, on the degree of grinding of the seeds, and the size distribution of the grinded material, [13].

The bulk density of a granular mixture is the mass of the material relative to the total volume it occupies in its natural state. This property is considered one of the basic qualitative indexes using in determining extraction flour, [14,15]. Wheat flour yield is closely related to the bulk density.

The moisture content of wheat seeds is one of their most important qualities, having a special role in the processing process, [16]. The moisture content of the wheat seeds is differentially distributed between the endosperm and the bran, which greatly influences the grinding process. Wheat seeds with low moisture content (12.5% - 12.8%) having a low elastic characteristic on dynamic loads, are fragile and easily to broke, requiring low energy consumption for crushing, [17]. At moisture contents ranging from 17-18%, the seeds behave like the elastic bodies, the particle diameter is larger, the flattening phenomenon occurs, the endosperm does not break [17,18,19]. The excessive wetting of the wheat seeds decreases the working capacity of the machines on the technological flow of the milling unit, because the seeds soften and the wet endosperm adheres to work surfaces. On the other hand, insufficient

wetting also negatively influences the milling process, as it causes the crushing of the bran and the appearance of an inseparable mixture of flour, [15,19].

It is known that the main mechanisms of fracture (grinding) of the material in the grinding process, in roller mills, are those crushing (compressive) and shear.

Figures 1 and 2 are shown the behavior of wheat seeds with low moisture content and, respectively, with high moisture content, subjected to compression and shear stresses.

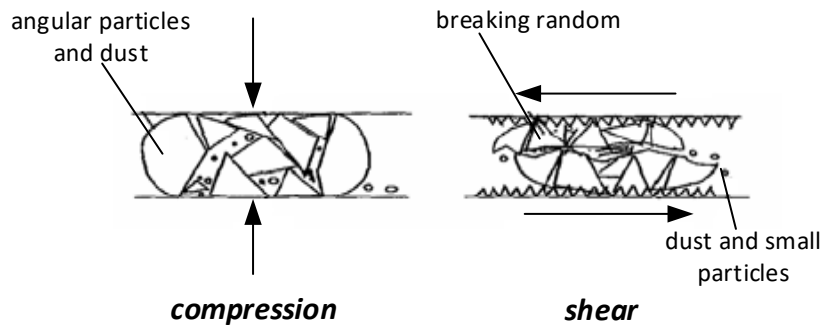

Figure 1: Grinding of wheat seeds with low moisture content (dry), [20]

When a wheat seed has a low moisture content, it is fragile, and when the grinding forces are applied, it is broken into coarse particles of polyhedral form, fines and very fine particles. If the application of force continues, the seeds begin to deform elastically, then the forces produce some plastic deformations before they crack or break. This is caused by the crack propagation at the application points, which are normally the contact points, [20].

Applying forces to seeds with higher moisture content results in a wide range of nearby particle sizes, few fine particles, and even flat aggregates (figure 2).

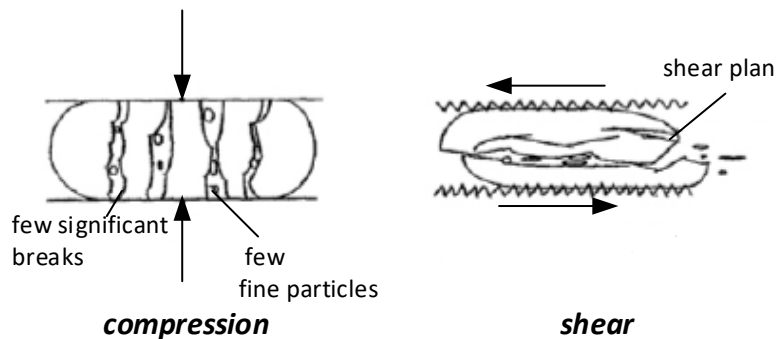

Figure 2: Grinding of wheat seeds with higher moisture content (wet), [20]

A wet wheat seed is relatively soft, and at the moment of applying a force it deforms, to a certain extent, elastic. Even if the applied force increases, a seed is able to maintain the plastic deformation, before breaking, more than a dry one, [20]. The application of shear tends to break the wet seeds along of different fracture planes, [20].

Knowing the value of the friction coefficient of cereals on different materials (metal, plastic, glass, rubber, wood, etc.) is of particular importance in the process of moving them on different surfaces, both in the transport and in the separation process, as well and to characterize bulk flow and storage properties [11]. The value of the coefficient of friction depends on the nature of the materials of the two bodies, the state of the surfaces, the contact pressure between them, [21,22].

The texture of wheat seed is an important factor in the process of grinding, in roller mills. Depending on the texture, wheat varieties are classified into two categories, namely: durum wheat and soft wheat. Between durum wheat varieties and soft wheat varieties are significant

differences regarding the conduct of grinding process. [7]. Hard texture is a genetic feature given by the compactness of the endosperm and the presence of a strong bond between proteins and starch, [23].

### 3. MECHANICAL CHARACTERISTICS

The values of the mechanical properties of wheat seeds (regardless of the variety) are necessary in estimating the behaviour of the grinding, the estimation of the energy consumed for deformation and crushing, and the estimation of the power of the machinery in the cereal mills.

Hardness is defined as a mechanical property of the seed grain to resist deformations or breakage, by the action of external forces and tensions. The crushing resistance of wheat seeds increases with increasing moisture content and glassiness, requiring a more intensive grinding process and implicitly higher energy consumption, [11,15]. The hardness occurs in the behavior of the seeds during the grinding process, influencing the force required to break the wheat, the way the seeds fragment, the size of the particles resulting from the breakage, and also the yield of the flour extraction, [12,23,24,25,26,27,28,29].

An example of fissures propagation in the case of durum wheat seeds was given by A.T.J. Gonzalez in the paper [23] and is shown in the figure 3.

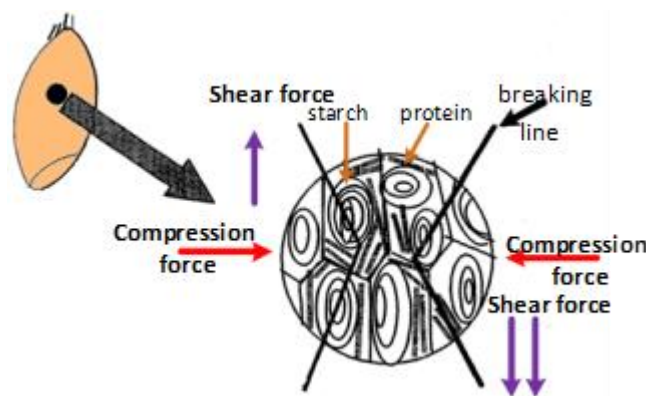

Figure 3: The way of breaking (fracture) the endosperm of a durum wheat seed during the grinding process, [23]

An important difference between soft wheat and durum wheat seeds is the limitations of endosperm fragmentation. In the case of durum wheat seeds, the endosperm is broken along the aleuronic layer (starch granules), resulting in a higher amount of flour, [23,25,30]. The endosperm of the durum wheat seed may be removed (easier) and more efficiently from the surface of the bran particles when the cutting forces applied by the milling rolls are directed along the boundaries between the cell walls of the endosperm. When they reach the skin layer, some forces are diverted along the interface of the aleuronic layer - the endosperm, it is thus facilitate separation of the bran particles, [25,30].

In the case of soft wheat variety, the process of grinding in roller mills presents real difficulties. In this case, much of the aleuronic layer remains attached to the endosperm, which is more difficult to remove from the surface of the bran. The cutting forces that have reached the endosperm are not redirected to the bran. This is described in the diagram of the action of the forces on the wheat endosperm during the grinding process, in figure 4, [25]. The largest arrow at the bottom of the diagram indicates the direction of shear force given by the differential velocity of the grinding rollers.

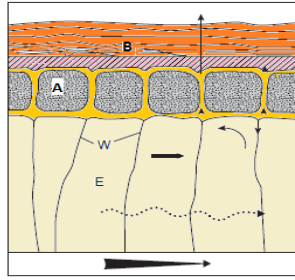

Figure 4: The action of forces on the endosperm cells of a wheat seed during the grinding process, [25]

A - the aleuronic layer; B - the bran layer; W - endosperm cell walls; E – endosperm

In the case of durum wheat, cell contents behave as a unit, and therefore the cell is totally broken off the aleuronic layer. In the case of soft wheat, the shear force passes through the contents of the cell, as indicated by the dotted arrow, [25]. Subsequent grinding with smooth surface rolls of grain particles resulting from soft wheat seeds is not as easy as when made from hard wheat seeds because of their flattening tendency, losing their granular character before their grinding is complete, [23,25,30]. After grinding, the particles of flour derived from soft wheat varieties are lightweight and have a smaller size-distribution, while durum wheat seeds break in the particle size within very wide limits, [12].

Another important factor influencing the grinding process is the physical condition of the seeds subjected to external forces and treatments during technological processes of harvesting, transportation, storage and conditioning [31,32]. Grain seeds are frequently affected by the operation of agricultural machinery during harvesting and transport. They are also damaged during post-harvest processing due to internal stresses induced by high humidity slopes occurring during the process of wetting and drying. Broken seeds are characterized by reduced mechanical strength and an easier crushing tendency during post-harvesting than seed without such damage. A consequence of these phenomena is the decrease in seed quality, [32].

#### 4. CONCLUSIONS

For the grinding process to be carried out with maximum efficiency, it is necessary to know precisely the characteristics of the products subject to grinding (the properties of the raw materials, the required quality conditions, the properties related to the texture of grinded products) and their influence on the grinding process.

The theoretical and experimental results on the physical and mechanical characteristics of the milling products from the technological flow of a wheat mill (porosity, bulk density, density, natural slope angle, granulometric analysis, hardness, etc.) are used to further choose the surface type of the milling rolls, correlation with the technological characteristics of the equipment on the technological flow (flute angle, flute position, roll speed, distance between milling rolls) and the characteristics of the screen surfaces of the frame plane sieves.

#### References

- [1] Fang Q., Hanna M., Haque E., Spillman C., *Neural network modelling of energy requirements for size reduction of wheat*, Transactions of the ASAE 43(6), 2000, p.947-952. [2] Gash, R., Twele, J., *Wind Power Plants*, James & James, London, 2002.
- [2] Blazek J., Jirsa O., Hruskova M., *Prediction of wheat milling characteristics by near-infrared reflectance spectroscopy*, Czech Journal of Food Science, vol.23, nr. 4, 2005, p. 145-151.
- [3] Song A., Chung D.S., Apillman C.K., Eckhoff S.R., *Physical properties of various fractions in commercial corn samples*. American Association of Cereal Chemists, vo.67(4), 1990, p.322-326.

- [4] Dżiki D., *Mechanical properties of single kernel of wheat in relation to debraning ratio and moisture content*, Acta agrophysica, 4(2), 2004, p.283-290.
- [5] Fang Q., Haque E., Spilman C.K., Reddy P.V., Steel J.L., *Energy requirements for size reduction of wheat using a roller mill*, Transaction of the ASAE, Vol.41(6), 1998, p.1713-1720.
- [6] Kheiralipour K., Karim M., Tabatabaefar A., Naderi M., Khoubakht G., Heidarbeigi K., *Moisture-depend physical properties of wheat (Triticum aestivum L.)*, Journal of Agricultural Technology, 4(1), 2008, p. 53-64.
- [7] Martin J.M., Meyer F.D., Morris C.F., Giroux M.J., *Pilot Scale Milling Characteristics of Transgenic Isolines of a Hard Wheat Over-Expressing Puroindolines*, Crop Science, vo.7, no. 2, 2007, p. 497-504.
- [8] Wilhelm L.R., Suter D.A., Brusewitz G.H., *Food & Process Engineering Technology*, Amer Society of Agricultural, 2005.
- [9] Dżiki D., Laskowski J., *Influence of kernel size on grinding process of wheat at respective grinding stages*, Polish Journal of Food and Nutrition Sciences, Vol. 13/54, Nr.1, 2004, pg. 29-33.
- [10] Byung-Sam Y., Wade B.B., Conrad P.L., *Value of Increasing Kernel Uniformity*, Western Agricultural Economics Association Annual Meetings, Logan, Utah, 2001.
- [11] Mohsenin N.N., *Physical properties of plant and animal materials, vol I (Structure, physical characteristics and mechanical properties)*, Gordon and Breach Science publishers, N.Y., 1970.
- [12] Alka Sh., *Wheat grain structure, quality and milling*, Post Graduate Diploma in Bakery Science and Technology.
- [13] Voicu Gh., Tudosie E-M., Paraschiv G., Voicu P., Ipate G., *Testing certain distribution laws regarding some physical characteristics of grinded wheat seed mixture inside milling units and the connection between them*, Proceedings of the 39. International Symposium on Agricultural Engineering, Actual Tasks on Agricultural Engineering. ISI – Index to Scientific & Technical Proceedings, Opatija, Croatia 2011, p.427-435.
- [14] Costin I., *Cartea morarului*, Editura Tehnică, București, 1988.
- [15] Panainte M., Moşneguţu E., Savin C., Nedeff V., *Echipamente de proces în industria alimentară. Măruntirea produselor agroalimentare*, Editura Meronia, 2005.
- [16] Thierer L.V., *Determinarea calităţii produselor agricole vegetale (Tehnica analizelor de laborator, stabilirea perisabilităţilor şi a valorii produselor)*, Editura Ceres Bucureşti, 1971.
- [17] Brătucu Gh., *Influenţa automatizării echipamentelor de condiţionat asupra procesului de măcinat grâu*, INMATEH, vol.27, nr.1, 2009, p. 110-116.
- [18] Lupu M., Rus F., *The influence of humidity of grain grinding process*, Proceeding of the International Conference BIOATLAS 2010 Transilvania University of Brasov, p. 60-64.
- [19] Voicu Gh., Ştefan E.M., Constantin G.Al. - *Milling of different moisture content wheat in mills with fluted rolls*, Buletinul Universitatii Petrol-Gaze din Ploiesti, Vol. LXXV, No.1, p. 35-42, ISSN 1224-8495, 2013.
- [20] Clarke B., Rottger A., *Small mills in Africa. Selection, installation and operation of equipment*, Food and Agriculture Organization of the United Nations, Roma 2006.
- [21] Voicu Gh., Tudosie E-M., Căsândroiu T., Biriş S-S., *Some aspects of physical properties of seeds and wheat products obtained from a roller mill*, Buletinul Institutului Politehnic din Iaşi, Universitatea Tehnică "Gheorghe Asachi" din Iaşi, Tomul LVI (LX), Fasc.4B, Iaşi 2010, pg.477-488, ISSN 1843-5246.
- [22] Voicu Gh., David M.F., Biriş S-Ş., Tudosie E-M., *Some physico-mechanical characteristics of the wheat grist in the breakage phase during milling process*, Bulletin UASVM Agriculture, Cluj, 66(2), 2009, p.524-531.
- [23] Jimenz G.A.T., *Milling process of durum wheat*, CIHEAM – Options Mediterraneennes.
- [24] Afkari Sayyah A.H., Minaei S., *Behavior of Wheat Kernels under Quasi-Static Loading and its Relation to Grain Hardness*, J.Agric. Sci. Technol., Vol.6, 2004, p.11-19.
- [25] Colin W., Harold C., Charles E.W., *Encyclopedia of Grain Science*, Elsevier Academic Press, 2004.
- [26] Dexter J.E., Doust M.A., Raciti C.N., Lombardo G.M., *Effect of durum wheat (Triticum turgidum L. var. durum) semolina extraction rate on semolina refinement, strength indicators and pasta properties*, Canadian Journal of Plant Science, 84, 2004, p.1001-1013.
- [27] Fang C., Campbell G.M., *Effect of measurement method and moisture content on wheat kernel density measurement*, Institution of Chemical Engineers Trans. Ichem, vo.78, Part.C, 2000, p.179-186.
- [28] Greffeuille V., Abecassis J., Rousset M., Oury F-X., Faye A., Bar L'Helgouac'h, Lullien-Pellerin V., *Grain Characterization and milling behaviour of near-isogenic lines differing by hardness*, Theor Appl Genet, 114, 2006, p.1-12.
- [29] Pomeranz Y., Martin C.R., Rousser R., Brabec D., Lai F.S., *Wheat Hardness Determined by a Single Kernel Compression Instrument with semiautomated Feeder*, Cereal Chem. vo.65(2), p.86-94.
- [30] Bailey C.H., *The relation of certain physical characteristics of the wheat kernel to milling quality*, The Journal of Agricultural Science, vol. 7, 1916, p.432-442.
- [31] Wozniak W., *Mechanical properties of wheat grain in relation to internal cracks*, Int. Agrophysics, 15, 2001, p.59-64.
- [32] Wozniak W., *The effect of two types of moisture treatment of wheat grain on endosperm damage*, Int. Agrophysics, 9, 1995, p.165-170.

# **SORT VARIATION PROCESS OF POWER FLOW IN A CONICAL SIEVE OSCILLATING**

Dorel Stoica<sup>1</sup>, Gheorghe Voicu<sup>1</sup>, Iulian-Claudiu Duțu<sup>1</sup>, Mihaela Florentina Duțu<sup>1</sup>

<sup>1</sup> University Politehnica Bucharest, Biotechnical Faculty of Engineering, Splaiul Independentei, 313, District 6, Bucharest, Romania, dorelstc@yahoo.com

## **ABSTRACT**

The objective of this paper is to present the influence of material feed flow on the separation process for a conical sieve with vertical axis and oscillating circular motion. Intensity separating curves of seeds of rape through circular aperture of sieve were traced by regression analysis of the quantities of material separated at different distances of the central axis of the sieve, using Lorentz distribution law. Coefficients of the regression equation and correlation coefficient of the distribution function with experimental data shows a high correlation between them. Material motion on sieve and separation process, generally, was assessed by peak position of the distribution curve, depending on the feed flow of material.

Key words: conical sieve, degree of sorting, oscillation frequency, regression analysis, power flow.

## **1. INTRODUCTION**

Removing the hazardous impurities from seed mass deposited and reducing or preventing of damage caused by impurities on the quality of seed crops lead to increase of the storage period and reduce of storage losses. In paper [1], was analyzed the influence of impurities on microbial activity and storage quality, at a temperature of 30°C and 80-90% relative humidity, in conditions of storage simulated. The results showed that the remaining impurities in the wheat seeds had a negative effect on the quality of their storage. Microbial activity took place faster and storage quality of wheat suffered. Therefore, impurities must be separated as much as possible before storing wheat, in order to reduce negative effects on grain quality during storage.

On the sieve of equipments for cleaning and sorting of seed crops, seeds are separated due to the state of sifting imprinted by oscillation movement of sieves and, eventually of a current of air that passes through the material layer on the sieve, from bottom to top. Material separation is a complex process influenced by many factors, such as: physical properties of components subjected to separation, separation surface geometry, kinematics and functional parameters of the sieve [2].

Shape and geometric characteristics of the sieve are chosen depending on the particle size of the material which must be separated. Feed mode and thickness of material on the sieve must be ensured by a uniform feed flow, at a flow too high being risk that in refusing of sieve to find and under-sized particles which must be sifted and did not meet the conditions of separation (to get into contact with the sieve and to have the time necessary for involvement in passing by apertures). Also, the length of the path traveled by the particles on the sieve is one factor that influences directly proportional the quality of separation.

Inclination angle of sieves and material particle shape subjected to sifting is also factors that indicate (shows) the effectiveness of sifting, [3,4].

Geometrical dimensions of particles and their distribution, as well as ratio between average particle size and characteristic size of sieve apertures influence the separation process, as follows: for values of average particle size  $d$  smaller than  $0.7a$  ( $a$  – diameter of sieve apertures or the small side of apertures elongated), particles easily pass through apertures, and for values  $d$  higher than  $1.5a$ , particles pass rapidly over the sieve and do not impede particles passing through small size apertures. For dimensions of particles  $d$ , ranging between  $0.7a$  –  $1.5a$ , they have a tendency to clog the apertures of sieve, in this case being need to have apertures with the dimension  $a$  higher with 10–15%, for an adequate separation [4,5].

Product temperature should be as close to ambient temperature or below, because it influences inversely proportional the separation capacity, in this regard the products are cooled for separation [4,5]. Electrical conductivity and static electricity influence negatively the sieving capacity of sieves [4,5]. Speed of displacement and character of motion on sieve material directly influences the material separation process, which is given by kinematics regime of screening block. In case of stationary sieves, displacement of particles occurs due inclination of sieve and only small impurities can be separated, without being able to make an adequate separation after the width or thickness of the particles [4,5].

Description of seeds separation on sieves with oscillatory motion was made by various authors in two different ways.

Some take the stochastic description of the separation process, through mathematical models which results on base of correlation with the results obtained in experiments of some functions or distribution laws existing in mathematical statistics [6]. Stochastic models can describe both the separation intensity of the material on sieve length, as well as cumulative separation of material at various distances from the feed end of the sieve along its length [6].

The second way of describing the separation process on sieve, is deterministic model that takes into account the main parameters that characterize the separation process, the mathematical model is determined by applying the theory of dimensional analysis, based on experimental research results for determining of dimensionless similarity criteria values and the coefficients of the mathematical model.

The paper presents the influence of material feed flow on the material motion and of separation process for a sieve with vertical conical outer work surface, having horizontal oscillating motion, for a preset oscillation frequency and four values of sieve oscillation amplitude.

## 2. METHODOLOGY

Experimental stand, presented in detail in papers [7,8] is composed of a conical sieve suspended with the separation surface of sheet with apertures perforated at  $\phi 4.2$  mm, with an inclination to the horizontal of  $8^\circ$ , actuated in oscillatory motion by an eccentric mechanism disposed tangentially at a distance  $d$  (variable), from the center of sieve. Sieve is suspended at the top and bottom using three metal cables with diameter 1.5 mm disposed circular at  $120^\circ$ .

Experiments were performed with rape seeds with dimensions between  $\phi 1.25$ – $2.5$  mm (in percentage of over 95%) and moisture content of 8.05%. In the seed mixture subject to separation were introduced straw particles with sizes between 3-4 mm in a percentage of approximately 3% [7,8].

Sieve oscillation amplitude was measured on the horizontal in the connecting point of sieve with arm 6, for maximum opening of connecting rod of actuator mechanism, [7,8].

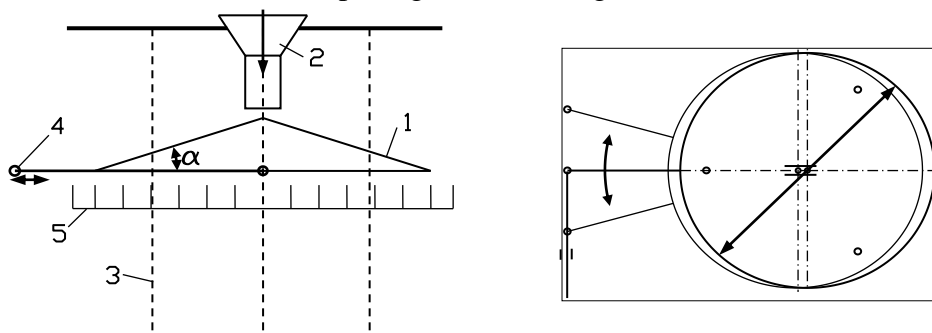

Fig.1. Scheme of suspended conical sieve used in experiments (views at  $90^\circ$ )

1. conical sieve with apertures  $\phi 4.2$  mm; 2. feed funnel adjustable for height; 3. steel elastic wire cables; 4. actuator mechanism with oscillating coulisse; 5. collecting box with concentric compartments; 6. connecting lever (arm) with the actuator mechanism connecting rod

Actuation system with eccentric allowed the modification of oscillation frequency in three steps (250, 520 and 790 min<sup>-1</sup>) and of oscillations amplitude in four steps. Diameter at basis of sieve cone was  $\phi 430$  mm, and the specific number of circular apertures on the surface of separation was 2.25 apertures/cm<sup>2</sup> (active surface of sieve around 31%), aperture diameter of sieve feed funnel  $\phi 25$  mm. Simplified scheme of the experimental installation is shown in Figure 1.

To express the influence of feed flow over separation process on conical sieve, seeds separated by sieve apertures were collected in a box with several concentric compartments for collecting. The mass of seeds collected in each compartment was reported at the initial mass of the sample (which was 0.500 kg), the results being presented in percentage compared to it. Feed flow was calculated reporting the mass of seeds of the sample at the drain time of the material from the funnel, which could be adjusted through the distance between the exhaust outlet and sieve. It should be noted that during the experimental measurements, it was found that straw impurities from mass of seeds were separated completely beyond the bottom of the sieve, at all tests performed, so that the process of separation is shown through the distribution of separate material along the length of basic cone radius of the sieve. Experimental results are presented in Table 1.

Were drawn, comparative (on the same chart), distribution curves of frequency separation of on the generatrix of sieve for three values of feed flow used in experiments, in condition in which the other parameters of the working regime (oscillation amplitude A and oscillation frequency F) were maintained constant. Based on experimental data, separation curves were drawn through nonlinear regression analysis using Lorentz law expressed by equation 1:

$$p_x(\%) = y_o + \frac{2A}{\pi} \frac{w}{4(x - x_c)^2 + w^2} \quad (1)$$

where:  $p_x(\%)$  represents the percentage weight of material separated on an interval of length (radius) of sieve. According to mathematical statistics in equation (1) „ $y_o$ , A” represents the regression coefficients that depend on the parameters of the operating mode, „ $x_c$ ” is the radius of sieve corresponding to the maximum percentage of seeds separated (or average from Lorentz distribution function), and „w” represents the dispersion from the position of maximum. These coefficients depend on the parameters of working regime of the sieve and is determined from regression analysis together with correlation coefficient R<sup>2</sup>.

The data summarized in Table 1 were processed and synthetic ordered by the values of feed flow and after oscillation amplitude at one of the three oscillation frequencies used in experiments (F=520 min<sup>-1</sup>).

Table 1. Variation of the quantity of material collected under the sieve (%), for oscillation frequency F=520 min<sup>-1</sup> and four sieve oscillation amplitudes at three material feed flows

Nr. crt.	F <sub>2</sub> = 520 osc/min, M <sub>p</sub> = 500g		Intervalul de sită de pe care se colectează semințe (m)								
	Amplitudinea oscilațiilor	Debitul de alimentare	Semințe separate	0	0,04	0,07	0,1	0,13	0,16	0,205	Peste sită
1	A <sub>1</sub> = 3,58 mm	Q <sub>1</sub> = 0,02 kg/s	g	0	113	120	140	125	2	0	0
			%	0	22,6	24	28	25	0,4	0	0
2		Q <sub>2</sub> = 0,033kg/s	g	0	104	131	108	99	56	2	0
			%	0	20,8	26,2	21,6	19,8	11,2	0,40	0
3		Q <sub>3</sub> = 0,042 kg/s	g	0	104	131	108	99	56	2	0
			%	0	20,8	26,2	21,6	19,8	11,2	0,40	0
4	A <sub>2</sub> = 3,74mm	Q <sub>1</sub> = 0,02 kg/s	g	0	201	215	84	0	0	0	0
			%	0	40,2	43	16,8	0	0	0	0
5		Q <sub>2</sub> = 0,033kg/s	g	0	133	157	88	55	30	17	20
			%	0	26,6	31,4	17,6	11	6	3,40	4



6		Q <sub>3</sub> = 0,042 kg/s	g	0	114	141	90	70	39	21	25
			%	0	22,8	28,2	18	14	7,80	4,20	5
7		Q <sub>1</sub> = 0,02 kg/s	g	0	195	210	94	1	0	0	0
			%	0	39	42	18,8	0,2	0	0	0
8	A* = 3,91 mm	Q <sub>2</sub> = 0,033kg/s	g	0	136	162	91	57	25	13	16
			%	0	27,2	32,4	18,2	11,4	5	2,6	3,2
9		Q <sub>3</sub> = 0,042 kg/s	g	0	115	150	88	65	36	20	26
			%	0	23	30	17,6	13	7,2	4	5,2
10		Q <sub>1</sub> = 0,02 kg/s	g	0	187	208	102	3	0	0	0
			%	0	28	36,6	19	12	4	0,4	0
11	A <sub>3</sub> = 4,10 mm	Q <sub>2</sub> = 0,033kg/s	g	0	140	183	95	60	20	2	0
			%	0	28,	36,6	19	12	4	0,40	0
12		Q <sub>3</sub> = 0,042 kg/s	g	0	115	155	90	59	34	19	28
			%	0	23	31	18	11,8	6,8	3,8	5,6

Based on the percentages of material collected under the sieve at different distances from the vertical axis of oscillation were drawn the charts shown in Figure 2, for the four amplitudes.

Each of the four charts shows three curves of distribution of material on the sieve collecting radius, representing the variation of the percentage of seeds separated depending on feed flow preset and used in experiments.

This separation curves were drawn by regression analysis of experimental data with Lorentz distribution function (eq 1), the allure of these curves is approximately the same, but with differences more or less significant depending on the working regime parameters used in experiments, respectively with feed flow.

Regression equation coefficient values (eq. 1, A<sub>o</sub>, x<sub>c</sub>, w), and the correlation coefficient values  $\chi^2$  and R<sup>2</sup> for the four amplitudes of oscillation at each of the three feed flows are shown in Table 2.

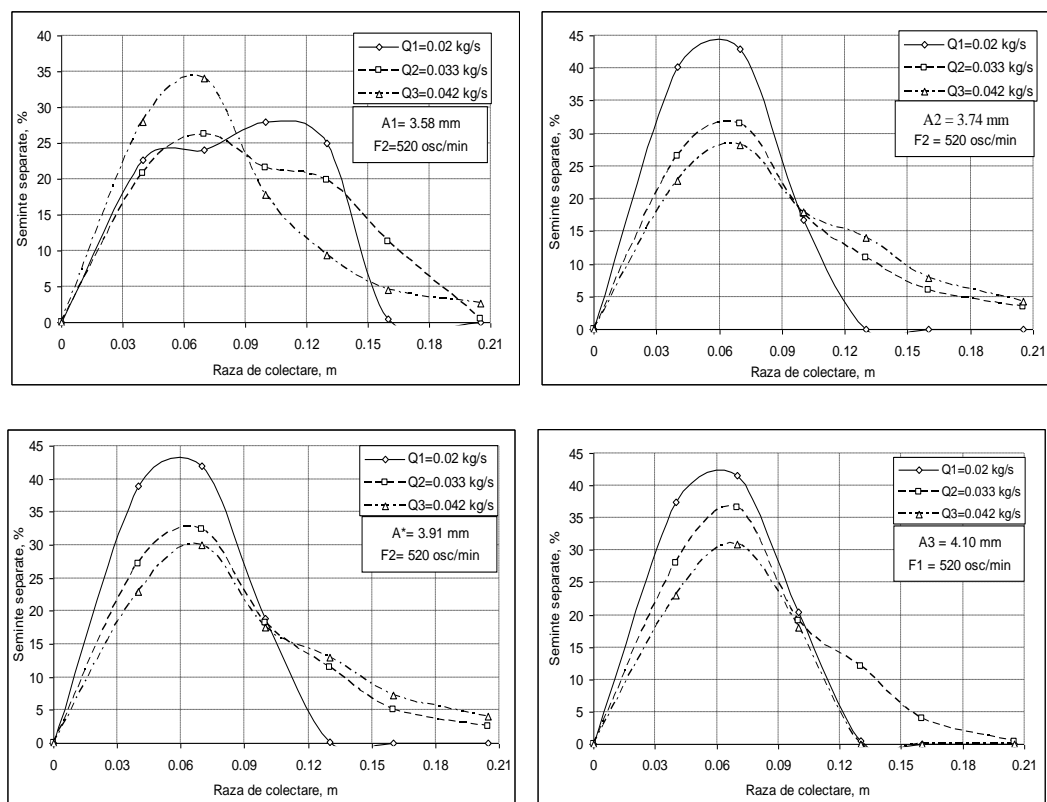

Fig.2. Feed flow influence on the process of separation of seeds on generatrix of conical sieve, at the frequency of oscillation  $F = 520 \text{ min}^{-1}$  and four amplitudes of oscillation

Analyzing the data in Tables 1 and 2 and the charts in Figure 2, it is found that the position of maximum separation curves for the three feed flows,  $Q_1 = 0.020$  kg/s,  $Q_2 = 0.033$  kg/s,  $Q_3 = 0.042$  kg/s, changes at each of the four amplitudes of oscillation.

Thus, if position point at the maximum separation curve is at 0.078 m by central vertical axis of oscillation of sieve for the amplitude of oscillation  $A_1 = 3.58$  mm, and flow  $Q_1$ , for increasing flow of material ( $Q_2, Q_3$ ), this point approaches the vertical axis of the sieve, influenced values, we suppose, and of sieve aperture sizes. It notes, however, a slight increase of material dispersion on the sieve, represented by  $w$  coefficient values in Table 2, for flow  $Q_1$ .

Table 2. Coefficients of the regression equation (eq. 1)  $A_0, x_c, w$  and correlation coefficients  $\chi^2$  and  $R^2$  with experimental data for three material feed flows, at the frequency of oscillation  $F = 520 \text{ min}^{-1}$  and four sieve oscillation amplitudes

No. sample	Lorentz function		$A_0$	$x_c$	$w$	$\chi^2$	$R^2$
	Working regime						
1	$A_1 = 3.58$ mm	$Q_1 = 0.020$ kg/s	43.281	0.078	0.029	24.569	0.960
2		$Q_2 = 0.033$ kg/s	38.624	0.066	0.032	10.231	0.971
3		$Q_3 = 0.042$ kg/s	34.784	0.066	0.033	18.749	0.928
4	$A_2 = 3.74$ mm	$Q_1 = 0.020$ kg/s	42.485	0.069	0.030	13.578	0.978
5		$Q_2 = 0.033$ kg/s	33.076	0.068	0.037	20.901	0.914
6		$Q_3 = 0.042$ kg/s	27.244	0.074	0.042	26.058	0.834
7	$A_* = 3.91$ mm	$Q_1 = 0.020$ kg/s	42.540	0.067	0.030	9.344	0.980
8		$Q_2 = 0.033$ kg/s	28.112	0.074	0.044	31.851	0.815
9		$Q_3 = 0.042$ kg/s	25.737	0.077	0.045	23.861	0.833
10	$A_3 = 4.10$ mm	$Q_1 = 0.020$ kg/s	42.835	0.066	0.030	8.336	0.982
11		$Q_2 = 0.033$ kg/s	25.814	0.080	0.049	30.284	0.787
12		$Q_3 = 0.042$ kg/s	23.728	0.082	0.049	20.659	0.832

If the amplitude of oscillation increases to  $A_2 = 3.74$  mm or  $A_* = 3.91$  mm and then at  $A_4 = 4.10$  mm for higher flows feed, respectively  $Q_2 = 0.033$  kg/s or  $Q_3 = 0.042$  kg/s, it appears that the material dispersion on sieve also increases.

For the amplitude of oscillation  $A_2 = 3.74$  mm, if at feed flow  $Q_1$  and  $Q_2$  separation curve at the maximum position does not change significantly, at feed flow  $Q_3 = 0.042$  kg/s, maximum separation curve moves to the edge of sieve at  $x_c = 0.074$  m as against 0.069 m, how is at feed flow  $Q_1$ .

Under the same conditions by increasing material dispersion on the surface of sieve, percentages of material separated at the point of maximum of the separation curve decreases with the increase of feed flow (see fig.2,b).

From the analysis of separation curves from figure 2, c, at the same frequency of oscillation  $F = 520 \text{ min}^{-1}$ , but at a slightly higher oscillation amplitude,  $A_* = 3.91$  mm, the material dispersion on the collecting radius of sieve increases with increasing of feed flow, percentages of material separated at the point of maximum decrease slightly, but maximum of separation curve moves significantly from the vertical axis of the sieve to the edge of its.

Thus, if at feed flow  $Q_1 = 0.02$  kg/s, position of maximum of separation curve is at  $x_c = 0.067$  m from the axis of oscillation of sieve, at feed flow  $Q_2 = 0.033$  kg/s maximum of separation curve moves from 0.074 m, to  $x_c = 0.077$ m for feed flow  $Q_3 = 0.042$  kg/s, where it can be assumed that the sieve can work at a much higher load of material at this oscillation amplitude for review oscillation frequency ( $F = 520 \text{ min}^{-1}$ ).

The same phenomenon can be observed from the analysis of separation curves from figure 2, d for oscillation amplitude  $A_4 = 4.10$  mm.

We note that the position of maximum of separation curve in relation to collecting radius of sieve, moves from oscillation axis to the edge of sieve with the increase of feed flow from 0.066 m (for  $Q_1 = 0.02$  kg/s) to  $x_c = 0.082$  m (for  $Q_3 = 0.042$  kg/s). It is to be noted that, (as well as the amplitude  $A_3$ ) percentages of material separated at higher feed flows decrease significantly with increasing of material dispersion separated on generatrix of sieve.

### 3. CONCLUSIONS

A vertical conical sieve with circular apertures and oscillating motion on the horizontal was used to analyze the process of sifting and separation of rape seeds through apertures, for three different feed flows and four oscillation amplitudes of sieve.

From the data presented in this paper, it was found that the position of maximum of distribution curve of separation changes with modification of feed flow and with oscillation amplitude of sieve. At low feed flows ( $Q_1=0.02$  kg/s), maximum of separation curve approaches the axis of oscillation of sieve with the increase of amplitude oscillation, while for higher feed flows, this point moves away from the axis of oscillation at increasing of amplitude oscillation.

Separation curves were drawn by regression analysis of experimental data with Gaussian distribution function, allure of these curves being approximately the same, but with differences more or less significant depending on the working regime parameters used in the experiments, respectively with feed flow.

We can say that at small feed flows ( $Q_1 = 0.02$  kg/s,  $Q_2 = 0.033$  kg/s) and low oscillation frequencies (as the one we presented previously,  $F = 520$  min<sup>-1</sup>) in experimental conditions performed in this paper, losses of material over the outer edge of the sieve are minimal (in table 2 these are equal with zero for flow  $Q_1$  and  $Q_2$ ).

The data presented in this paper can provide a reference base for specialists (designers and users of equipments) in the processing field of seeds crops and, in particular, those in the cleaning and conditioning of them before storage and industrial processing.

### References

1. Căsandriou, T.; Voicu Gh.; Maican E.; A Mathematical model for the seed losses prediction on the cleaning system sieves of the harvesting combines, Modelling and optimization in the machines building field MOCM – 14, vol.2, Romanian Technical Sciences Academy, University of Bacău, 2008.
2. Elfverson, C.; Regné, S.; Comparative precision of grain sieving and pneumatic classification on a single kernel level, Applied Engineering in Agriculture, VOL. 16(5): 537-541.
3. Căsandriou, T.; Voicu Gh.; Curba de separare a materialului pe lungimea sitei superioare la sistemul de curățire al combinelor de cereale, București, 1992.
4. Stoica, D.; Stanciu, G.; Influence the degree of sorting the separation process a conical sieve: Digest Journal of Nanomaterials and Biostructures , ISSN 1842 - 3582 , Vol. 8, No. 2, April - June 2013, pp. 513 – 518.
5. Stoca, D.; Voicu, Gh.; Ungureanu, N.; Voicu, P.; Carp-Ciocardia, C.D.; Influence of oscillations amplitude of sieve on the screening process for a conical sieve with oscillatory circular motion, Journal of Engineering studies and research, Bacău, 2011, pp 83-89.
6. Voicu, Gh.; Căsandriou, T.; Țuțuianu, G.D.; Aspects regarding the powering by vibration generators with rotation masses of the classifying plane sieves blocks, Modelling and optimization in the machines building field MOCM-9, vol.1, Technical Sciences Academy of Romania, 2003, pp.111-116.
7. Târcolea, C.; Căsandriou, T.; Voicu, G.; Stochastic models for simulating seed separation process on sieves, Proceedings of the 36th International Symposium "Actual tasks on agricultural engineering", Opatija, Croatian, 2008, pp.293-306.
8. Letošnev, N.M.; Mașini agricole (traducere din lb. rusă), Editura Tehnică, București, 1963.
9. Stoica, D.; Contribuții la studiul fenomenelor vibratorii privind utilajele din domeniul prelucrării produselor agricole, teză de doctorat, Bucuresti, 2011.
10. Stoica, D., Rusănescu C.O., Research on the Influence of Vibration Frequency on A Conical Sieve Suspended – Metalurgia International, vol.XVIII (2013), nr.3, ISSN 1582 – 2214, pp 84-86.
11. Stoica D., Rusănescu C.O., Research on Variation of Displacements, Velocities and Accelerations at a Site Selector Blocks (Fanner) Grain - Magazine of Hydraulics, Pneumatics, Tribology, Ecology, Sensorics, Mechatronics, "HIDRAULICA" (No. 3/2013), ISSN 1453 – 7303, p 38-42.
12. Stoica, D., Voicu, Gh., Rusănescu, C.O., Influence of vibration amplitude oscillations on the conical sieve suspended, Bulletin of University of Agricultural Sciences and Veterinary Medicine Cluj-Napoca. Agriculture, volum 69, nr 1 , 2012/12/11.
13. Rusănescu, C.O., Rusănescu, M.T., Iordănescu, Fl., Anghelina, V., Mathematical relations between alloying elements and technological deformability indexes, Journal of optoelectronics and advanced materials, Vol. 15, No. 7-8, 2013, p. 718-723.

# CHANGES IN BULK DENSITY AS INDICATOR OF SOIL COMPACTION

Nicoleta UNGUREANU<sup>1</sup>, Valentin VLĂDUȚ<sup>2</sup>, Sorin-Ștefan BIRIȘ<sup>1</sup>, Bianca-Ștefania ZĂBAVĂ<sup>1</sup>, Mirela DINCĂ<sup>1</sup>

<sup>1</sup>Politehnica University of Bucharest, Faculty of Biotechnical Systems Engineering, Romania;

<sup>2</sup>INMA Bucharest, Romania

## ABSTRACT

Soil compaction consists in the increase of bulk density, respectively the decrease of porosity due to natural causes, such as: particle size variability, raindrops impact, soil wetting, internal soil water tensions, seasonal cycles, or artificial causes: agricultural machinery traffic and animal trampling. In compacted soils, high mechanical resistance limits the absorption of water and nutrients by the plants and reduces the development of roots. Hence, both agricultural production and food safety, and the welfare of farmers are affected not only due to reduced yields but also due to the costs to reduce soil compaction. This paper presents the results of experimental research conducted on a plot of white clover, aiming to determine one of the most important indicators of compaction, namely the bulk density of soil at depths between 0-45 cm, in increments of 5 cm and to determine the degree of soil compactness.

## 1. INTRODUCTION

Soil compaction is a form of soil degradation, described by the packing effect of a mechanical force on the soil, resulting in the decrease of the volume occupied by pores and increase of the density and strength of the soil mass. Furthermore, the number of large pores decreases, which slows the rate of infiltration and drainage from the compacted layer. This occurs because large pores are the most effective in transporting water when the soil is saturated [4].

Within agriculture, compaction of soil is induced by trampling of animals and by the repeated traffic of heavy machinery and this affects nearly all soil functions. All farming operations, starting with seedbed preparation, fertilizer and chemical applications, harvesting and transport increase the risk of artificial compaction of the agricultural soil. Nowadays, the risk of soil compaction increased and it has significant negative effects both on the environment and agriculture.

The driving force behind the compaction problem is the efforts of farming to remain economically viable in a society where salaries are generally high. Reduction of the workforce involved in farming operation requires larger and more efficient machinery. In the developed and industrialized countries, modern agriculture is characterized by an intense mechanization that allows for production of food at affordable prices. The pressures on the soil system are increased by frequent traffic and/or heavy machinery [10].

Common indicators of soil compaction are bulk density and penetration resistance [5, 7, 8]. Bulk density determines the degree of loosening or compaction of the soil (Table 1).

The term compactness is sometimes used for the resulting density state of the soil following compaction. Since soil bulk density is the mass of dry soil per unit volume, then the relationship between soil compaction and its capacity to store and transport water or air is obvious. For this

---

<sup>1</sup>Splaiul Independenței 313, sector 6, Bucharest, 0724086492, nicoletaung@yahoo.com

reason the dry soil bulk density is the most frequently used parameter to characterize the state of soil compactness. However, in swelling/shrinking soils the bulk density should be determined at standardized moisture contents, to prevent problems caused by water content variations [5].

Table 1: Classes of bulk density [11]

Type	Bulk density [kg/m <sup>3</sup> ] for mineral soils with texture:					
	Sandy	Sandy- loam	Loamy- sand	Loamy	Loamy- clay	Clayey
Extremely low (very loose soil)	< 1.28	< 1.21	< 1.18	< 1.13	< 1.05	< 0.94
Very low (moderate loose soil)	1.28 – 1.40	1.21 – 1.34	1.18 – 1.31	1.13 – 1.25	1.05 – 1.18	0.94 – 1.07
Low (weak loose soil)	1.41 – 1.53	1.35 – 1.47	1.32 – 1.45	1.26 – 1.39	1.19 – 1.31	1.08 – 1.20
Average (low compacted soil)	1.54 – 1.66	1.48 – 1.61	1.46 – 1.58	1.40 – 1.53	1.32 – 1.45	1.21 – 1.34
High (moderate compacted soil)	1.67 – 1.79	1.62 – 1.75	1.59 – 1.72	1.54 – 1.66	1.46 – 1.58	1.35 – 1.47
Very high (strong compacted soil)	1.79	> 1.75	> 1.72	> 1.66	> 1.58	> 1.47

According to [10], strictly speaking, the indicators would rather reflect compactness than compaction, which by definition is a process and not a state. Quantification of the soil density indicator can be done by sampling of undisturbed soil samples or by indirect methodologies (e.g., gamma-ray (density) and penetration resistance measurements).

Bulk density characterizes each type of soil, depending on its textural class. Soil resistance also depends on its moisture, texture and bulk density. The higher the bulk density of a soil type, the greater will be the resistance it opposes to the agricultural works. In soils with high bulk density, there are affected processes such as: water infiltration, the activity of soil microorganisms, porosity, and availability of nutrients necessary for plants, root penetration into the soil, hence processes that in turn will affect soil productivity and farmers welfare.



Figure 1: Agronomic effects of soil compaction: restricted root elongation and visible compacted areas with poor plant emergence [12]

Soil bulk density refers to the density of the soil as a whole, including solid particles as well as pores. It is determined on oven-dry undisturbed samples. The value of soil bulk density range between 1000 kg/m<sup>3</sup> to 2650 kg/m<sup>3</sup>. A compacted soil achieves bulk density in excess of 2300 kg/m<sup>3</sup>. Most mineral soils have bulk densities between 1100-1600 kg/m<sup>3</sup> [6].

To make results more comparable between soils, the bulk density can be expressed relative to a reference value, i.e. the bulk density obtained in a standardized procedure, such as a Proctor test or a uniaxial compression test [1]. Typically, soil density increases with depth because

lower soil layers are more compact, with lower content of organic matter, and in these layers the penetration resistance encountered by plant roots is higher, unlike in the upper layers with higher porosity.

It is generally accepted that nearly 80% of the compaction caused by wheeled traffic occurs on the first pass. This is the basis for suggesting the same track be used for repeated passes (controlled traffic) [4]. However, this response to traffic is related to the initial level of soil compaction and the distribution in deep layers [3].

Crop yields are reduced when soil compaction decreases crop emergence, crop growth, and nutrient uptake. Some researchers estimate soil compaction can reduce yield as much as 60%. In Romanian soils, Canarache et al. found that for each 100 kg/m<sup>3</sup> increase in bulk density, a decrease in maize grain yields was 18% less than yields on a non-compacted plot. These authors showed that changes in soil physical properties, as well as the yield of maize grain, were shown to be related to the number of tractor passes. Most of the changes were recorded between 0 and 8–10 passes, while with more than 15–20 passes changes became negligible [2].

Although there have been numerous research in the field of soil compaction and its effects on agricultural crops, it is difficult to estimate the economic impact of this phenomenon, as agricultural soils differ by their type, crop rotation and climatic conditions. Constant measurement of the indicators of soil compaction, such as penetration resistance and bulk density, allows making recommendations to the farmers with regard to the technologies and agricultural equipment to use in order to reduce the risk of soil compaction. Besides, the rooting depth, and the depth until which the compaction takes place or the depth of the hardpan layer can be established.

Rooting depth influences the ability of plants to access water and nutrients. Literature studies on the root depth distribution of white clover are limited, but have found up to 70 % of the total root mass occurs in the topsoil at 10–15 cm [9]. However, in compacted soils, white clover roots can expand down to 50 cm deep as they find their way in cracks and fissures [13].

The tests undertaken in this study aimed to determine the bulk density of soil on two plots of white clover, in order to evaluate the depth at which compaction, which could impede root growth and penetration, is found.

## 2. METHODOLOGY AND RESULTS

In the first set of tests, carried out on a plot of white clover, soil samples to determine the bulk density were taken in three points, in increments of 5 cm, to a depth of 45 cm, and in each of these points, soil moisture was measured using the FieldScout TDR 300 capacitive portable moisture analyzer.

Determination of bulk density was performed according to the methodology described in STAS 12836-90, "Tractors and Agricultural Machinery. Methods for determining the conditions for field testing" and the related standard STAS 7184 / 9-79, "Soils. Determination of density and bulk density".

The experimental data on the bulk density of the soil tested at three moisture contents, as well as the values obtained through mediation are presented in Table 2. Also, it was determined the degree of compactness of agricultural soil at each depth, for which we propose the following calculation formula:

$$GC = \left( \frac{\rho_{a\max} - \rho_{aef}}{\rho_{a\max}} \right)_0 - \left( \frac{\rho_{a\max} - \rho_{aef}}{\rho_{a\max}} \right)_z [\%] \quad (1)$$

where:  $\rho_{a\max}$  is maximum bulk density [kg/m<sup>3</sup>];  $\rho_{aef0}$  is effective bulk density at soil surface [kg/m<sup>3</sup>];  $\rho_{aefz}$  is effective bulk density at depth  $z$  in the soil [kg/m<sup>3</sup>].

Table 2: Bulk densities measured on the clover plot and the degree of compactness

Soil depth [cm]	Soil moisture [%]			Average moisture [%]	Degree of compactness [%]
	29	37.7	36	34.23	
	Bulk density [kg/m <sup>3</sup> ]			Average bulk density [kg/m <sup>3</sup> ]	
0	1020	1090	1064	1058	-
5	1127	1138	1200	1155	5.61
10	1240	1210	1286	1245	10.81
15	1318	1300	1378	1332	15.84
20	1380	1386	1439	1402	19.89
25	1512	1437	1570	1506	12.89
30	1572	1514	1600	1562	29.15
35	1628	1580	1640	1616	32.27
40	1683	1676	1683	1680	35.97
45	1721	1738	1730	1729	38.8

Based on the measured data, the curves of bulk density variation with the depth of the agricultural soil were graphically plotted. Figure 2 highlights the increase in bulk density of clover plot with increasing soil depth and soil moisture.

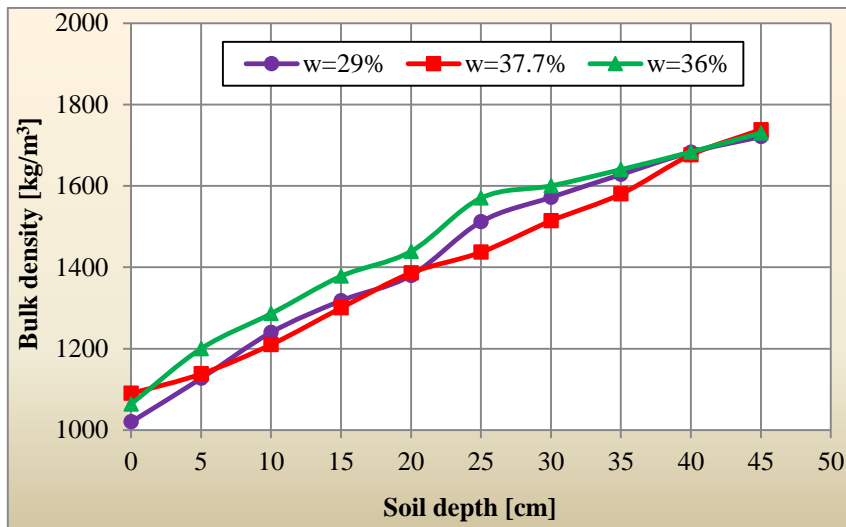

Figure 2: Variation of bulk density with soil depth at different moisture content

The second set of tests aimed to determine soil bulk density prior to the passage of 40 kN New Holland tractor (control sample), and after one pass, respectively after two passes on another plot. The degree compactness was calculated (Eq. 1) under these conditions. The results are given in Table 3 and the variation of bulk density with soil depth after each passage is graphically represented in Figure 3. It can be seen that, relative to the experimentally obtained values on the control field, the most significant increase in bulk density occurred after the first pass, and the bulk density values obtained after the second passage had a slower increase compared to the values obtained after the first pass. This confirms the data from the literature, according to which the most pronounced compaction occurs after the first pass of the agricultural machine on the soil compared to the compaction due to subsequent passages.

Table 3: Bulk densities and degree of compactness after repeated passes of the tractor

Soil depth [cm]	Number of tractor passes			After 2 <sup>nd</sup> passes	
	0	1	2	Average bulk density [kg/m <sup>3</sup> ]	Degree of compactness [%]
	Bulk density [kg/m <sup>3</sup> ]				
0	1130	1230	1276	1212	-
5	1183	1280	1340	1267	3.26
10	1200	1300	1364	1288	4.51
15	1320	1348	1392	1353	8.37
20	1340	1396	1438	1391	10,63
25	1362	1428	1458	1416	12.12
30	1396	1446	1518	1453	14.32
35	1480	1586	1640	1568	21.15
40	1549	1660	1673	1627	24.65
45	1600	1700	1750	1683	27.98

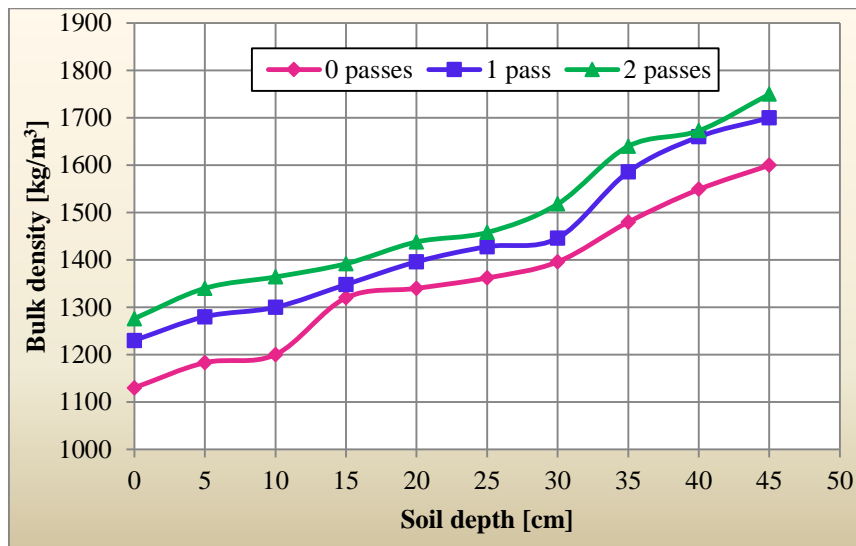

Figure 3: Variation of bulk density with soil depth at different number of passes

Although in Figures 2 and 3 the tendency is linearly increasing for bulk density on a depth of 0-45 cm, there is an area where the variation is random or presents a slightly sinusoidal variation, which may lead to the conclusion that the soil does not completely homogeneous in terms of moisture, structure and texture, but it is very likely that these variations are due to the existence of stiffness barriers of consistency.

Also it can be seen that in the first set of experiments, at 20-25 cm deep there is a jump of the bulk density values, which again can lead to the conclusion that there is a denser layer of soil in this area resulting from soil processing by agricultural work on the depth 0-20 (0-25) cm and leading to the appearance of the hardpan.

It is possible that, at a depth of 20-25 cm, the composition of the soil, i.e. its stratification, will change from loamy-clay to clayey-loam. Hardpan presence also influences the distribution of stresses in the soil. In uniform soil, stresses will propagate deeper into the subsoil, causing compaction of these soil layers. In the case of stratified soil, the presence of hardpan resulting from soil works at the same depth each year is beneficial for limiting the propagation of stresses to greater depths, so it will limit depth compaction.



### 3. CONCLUSIONS

Bulk density is one of the most important indicators of soil compaction. This parameter has linear increasing variation with soil depth.

Tests revealed that in the topsoil (between 0-20 cm), bulk density has relatively small values, but they grow beyond this depth. The increase of bulk density on the 20-25 cm depth indicates the presence of hardpan, which can restrict root growth above this layer, altering root architecture and their ability to uptake water and nutrients.

Regarding the influence of the number of passes of the tractor on the clover plot, the most obvious increase of bulk density was recorded after the first pass.

The degree of soil compaction increases with depth. On the clover plot the highest compaction values were obtained, between 5.61% (at 5 cm depth) and 38.8% (at a depth of 45 cm). After the second pass of the tractor, the degree of compaction varied between 3.26% (at 5 cm depth) and 27.98% (at a depth of 45 cm).

### ACKNOWLEDGEMENT

This work has been funded by University Politehnica of Bucharest, through the “Excellence Research Grants” Program, UPB–GEX2017, Ctr. No. 61/25.09.2017, internal number IS 25.17.03/2017 (COMPSOL)”.

### References

- [1] Arvidsson J., Hakansson I., *Response of different crops to soil compaction—Short-term effects in Swedish field experiments*, Soil & Tillage Research, vol. 138, pp. 56–63, 2014.
- [2] Botta G.F., Rivero D., Tourn M., Bellora Melcon F., Pozzolo O., Nardon G., Balbuena R., Tolon-Becerra A., Rosatto H., Stadler S., *Soil compaction produced by tractor with radial and cross-ply tyres in two tillage regimes*, Soil & Tillage Research, vol. 101, pp. 44-51, 2008.
- [3] Botta G. F., Tolon Becerra A., Bellora Tourn F., *Effect of the number of tractor passes on soil rut depth and compaction in two tillage regimes*, Soil & Tillage Research, vol. 103, 2009, pp. 381-386.
- [4] Guclu Yavuzcan H., Vatandas M., Gurhan R., *Soil strength as affected by tillage system and wheel traffic in wheat -corn rotation in central Anatolia*, Journal of Terramechanics, vol. 39, pp. 23–34, 2002.
- [5] Hamza M.A., Anderson W.K., *Soil compaction in cropping systems. A review of the nature, causes and possible solutions*, Soil & Tillage Research, vol. 82, pp. 121-145, 2005.
- [6] Lestariningsih I. D., Hairiah Widiyanto K., *Assessing soil compaction with two different methods of soil bulk density measurement in oil palm plantation soil*, Procedia Environmental Sciences, vol. 17, pp. 172 – 178, 2013.
- [7] Leung Y-F., Meyer K., *Soil compaction as indicated by penetration resistance: a comparison of two types of penetrometers*, Technology for Resource Management, pp. 370-375, 2003.
- [8] Mari G.R., Changying J., *Influence of agricultural machinery traffic on soil compaction patterns, root development, and plant growth, overview*, American-Eurasian Journal Agriculture & Environment Science, vol. 3(1), pp. 49-62, 2008.
- [9] Nichols S.N., Crush J.R., Woodfield D.R., *Effects of inbreeding on nodal root system morphology and architecture of white clover (*Trifolium repens* L.)*, Euphytica, vol. 156, pp. 365–373, 2007.
- [10] Stolte J., Tesfai M., Øygarden L., Kværnø S., Keizer J., Verheijen F., Panagos P., Ballabio C., Hessel R., *JCR Technical Reports – Soil threats in Europe. Status, methods, drivers and effects on ecosystem services. A review report*, deliverable 2.1 of the RE CARE project, 2016.
- [11] Ungureanu N., *Contributions to the modelling of artificial compaction of agricultural soil*. Doctoral thesis, 2015. University Politehnica of Bucharest, Romania.
- [12] Ungureanu N., Vlăduț V., Dincă M., Zăbavă B.Șt., Vlăduț D.I., Bolintineanu Gh., *Artificial compaction given by penetration resistance in soils with different use*, Annals of the University of Craiova – Agriculture, Montanology, Cadastre Series. Vol. XLVII/2, pp. 438-446, 2017.
- [13] Vidrih T., *Soil compaction and growth of roots on grass/white clover pasture* (<http://www.fao.org/docrep/v2350e/v2350e0v.htm>).

# REUSE OF WASTEWATER FOR IRRIGATION, A SUSTAINABLE PRACTICE IN ARID AND SEMI-ARID REGIONS

Nicoleta UNGUREANU<sup>1</sup>, Valentin VLĂDUȚ<sup>2</sup>, Mirela DINCĂ<sup>1</sup>, Bianca-Ștefania ZĂBAVĂ<sup>1</sup>,  
Iulian VOICEA<sup>2</sup>, Mario CRISTEA<sup>3</sup>

<sup>1</sup>Politehnica University of Bucharest, Faculty of Biotechnical Systems Engineering, Romania;

<sup>2</sup>INMA Bucharest, Romania; SC Cantarprod SRL

## ABSTRACT

The problem of water resources is aggravating as a result of accelerated urbanization, population growth, industrial and agricultural development. In addition to these factors, climate changes represent a substantial risk because it affects considerably both water resources and crops. Globally, agriculture is the largest consumer of water, accounting for approximately 70% of all freshwater. Farmers in many arid and semiarid areas are forced to find solutions to irrigate their crops, so they often must use treated, untreated or undiluted wastewater which is cheaper than other water sources. Increasing water needs (for drinking, food and irrigation) make the use of effluents (treated wastewater) an effective solution to solve the problem of water scarcity, to save significant quantities of drinking water, to reduce the use of chemical fertilizers (nutrients in the wastewater can replace conventional fertilizers), thereby protecting the environment and improving crop yield.

## 1. INTRODUCTION

The volume of wastewater generated by domestic, industrial and commercial sources has increased with population, urbanization, improved living conditions, and economic development.

Droughts and water scarcity are major issues not only in dry lands, but also in world regions where freshwater is abundant [9]. Many regions around the world are already facing these problems, for example the southern states of the USA, North Africa, the Middle East and Australia, and half of the European countries are facing water stress with water scarcity [4]. It is estimated that more than 40% of the world's population is now experiencing water stress [7] and will face scarcity within the next 50 years, a serious incentive to achieve sustainable management options of the water resources [20].

Romania is relatively poor in water resources, with only 1870 m<sup>3</sup> of water /inhabitant /year, compared to the average of 4000 m<sup>3</sup> of water /inhabitant /year in Europe. In 2014, Romania's water demand was 7.21 billion m<sup>3</sup>/year. According to Eurostat, in 2013 the water exploitation index was 15.2%, which is below the 20% water stress threshold of the Member States. A significant part of Romania's agricultural area already shows the negative effects of the drought and of poorly functioning irrigation systems. The total irrigated area in Romania is 2.99 million hectares, out of which 85% uses water from the Danube. Between years 2011 and 2015, the irrigated soil surface in Romania represented less than 300000 ha (1%) of total arable land, consuming about 1 million m<sup>3</sup> water/ year [8].

Romania's accession to the European Union requires compliance with European requirements, and the reuse of wastewater effluents is in line with Objective 6 of the European Union's Sustainable Development Strategy. In Romania, reuse of irrigated water is not largely practiced (there is a low demand for the global use of treated wastewater), and different

---

<sup>1</sup>Splaiul Independenței 313, sector 6, Bucharest, 0724086492, nicoletaung@yahoo.com

wastewater treatment methods for reuse are only addressed at the experimental level. Although the Romanian legislation does not prohibit the use of irrigated waste water, the relatively low number of users connected to the irrigation system does not stimulate investment in new waste water treatment technologies in order to use them as irrigation water. However, in the long term, the interest in reuse of irrigated water could increase, as Romanian agriculture continues to be dependent on climatic factors.

As the domestic demand for clean water increases and drought conditions become frequent, it is essential to think about non-conventional water resources to satisfy the increased rates of demand for freshwater. The main (re)uses of treated wastewater are: irrigation (both agricultural and landscape), recharge of aquifers, seawater barriers, industrial applications, dual-distribution systems for toilet flushing, and other urban uses.

An increasingly common practice encouraged by governments worldwide is the on the recovery and reuse of treated wastewater for irrigation of vegetable and energy crops. Despite strong government support, treated wastewater use in irrigation has faced several constraints, chief among them being problems of social acceptance, agronomic considerations and sanitation, and restrictive regulations that have tended to limit its full potential for development [17]. Unlike clean water, wastewater flows do not vary with seasons, climatic conditions, or precipitation levels, thus allowing farmers to grow crops throughout the year.

The reuse of treated wastewater is a valid option, in some cases urged by the absence of viable alternatives and also due to costly wastewater treatment for discharge. Nevertheless, untreated streams are still commonly used in several developing countries lacking collection and sanitation services [18]. In order to safely reuse treated municipal wastewater for irrigation purposes, all environmental, chemical, geological, and public health parameters related to land use ecology should be considered [5].

Irrigation with raw, partially and treated wastewater is a widespread practice in many arid and semiarid zones and it has potential for both positive and negative environmental impacts. With proper planning and management, the use of treated wastewater in agriculture can be beneficial to the environment.

With respect to the positive impacts, irrigation with treated wastewater can reduce the use of natural water resources; wastewater reuse will also reduce the discharge of effluents into freshwater ecosystems [4]. As half of the global water bodies are seriously contaminated, wastewater treatment and reuse promote environmental security by alleviating the pollution of freshwater resources, while providing more water for irrigation [6]. In addition, wastewater contains high amounts of organic matter and nutrients (like nitrogen and phosphorous) which are beneficial for plants [2] and hence avoids fertilizer usage.

Some long-term negative impacts are: the content on heavy metals which are toxic to plants beyond a certain limit; increasing soil salinity due to high concentrations of soluble salts transported by the wastewater, causing soil sealing, solidification and sodium accumulation, which could cause increased electrical conductivity, run off and soil erosion [16]. Excessive soil salinity imposes hyper-osmotic, oxidative stress and ion toxicity, constituting a limiting factor for plant growth, development and productivity. On the other hand, soil solidification affects negatively the stability of soil aggregates and soil structure, leading to an increase of soil compaction, loss of soil permeability and reduction of hydraulic conductivity [4].

It seems that the microbial pathogens contained in the wastewater (bacteria, viruses, protozoa, and nematodes) can pose environmental and health risks, but these pathogens can be removed by physical and biochemical treatment processes.

Nevertheless, the direct and indirect uses of untreated wastewater in irrigation especially in arid and semi-arid countries are increasing due to increasing global water scarcity, inappropriate wastewater treatment and disposal and escalating fertilizer costs [13].

## 2. METHODOLOGY

It is estimated that presently 70% of world water use including the water diverted from rivers and pumped from underground is used for agricultural irrigation, so that the reuse of treated municipal wastewater for agricultural and landscape irrigation reduces the amount of water that needs to be extracted from natural water sources as well as reducing discharge of wastewater to the environment [12].

The traditional irrigation not only causes huge waste of water resources, but is unable to meet the irrigation requirements, as agricultural crops have various varieties, and different requirements for irrigation water volumes, locations, and irrigating methods [21].

The earliest documented sewage treatment units applying wastewater for agricultural use were constructed in the 16<sup>th</sup> and 17<sup>th</sup> centuries in Germany and Scotland [3]. In developed countries, irrigation with treated wastewater is already a sustainable practice. In many developing countries, wastewater treatment is still limited, as investments in treatment facilities have not kept pace with persistent increase in population and the consequent increase in wastewater volume. Thus, much of the wastewater generated is not treated, and much of the untreated wastewater is used for irrigation by small-scale farmers with little ability to optimize the volume or quality of the wastewater they receive [15]. The productive use of wastewater has increased, as millions of small-scale farmers in urban and peri-urban areas of developing countries depend on wastewater or wastewater polluted water sources to irrigate high-value edible crops for urban markets, often as they have no alternative sources of irrigation water [14].

Usually, municipal wastewater and/or farm wastewater, untreated, diluted or treated is used for the irrigation of vegetable crops and energy crops. At least 10% of the global population consumes foods produced by irrigation with wastewater and over 20 million hectares (10% of all irrigated land) are irrigated with untreated, partly treated/diluted or treated wastewater around the world (Fig. 1). It also has been reported that over 200 million farmers in approximately 44 countries are reusing over 15 million m<sup>3</sup>/day of reclaimed water for irrigation purposes [7].

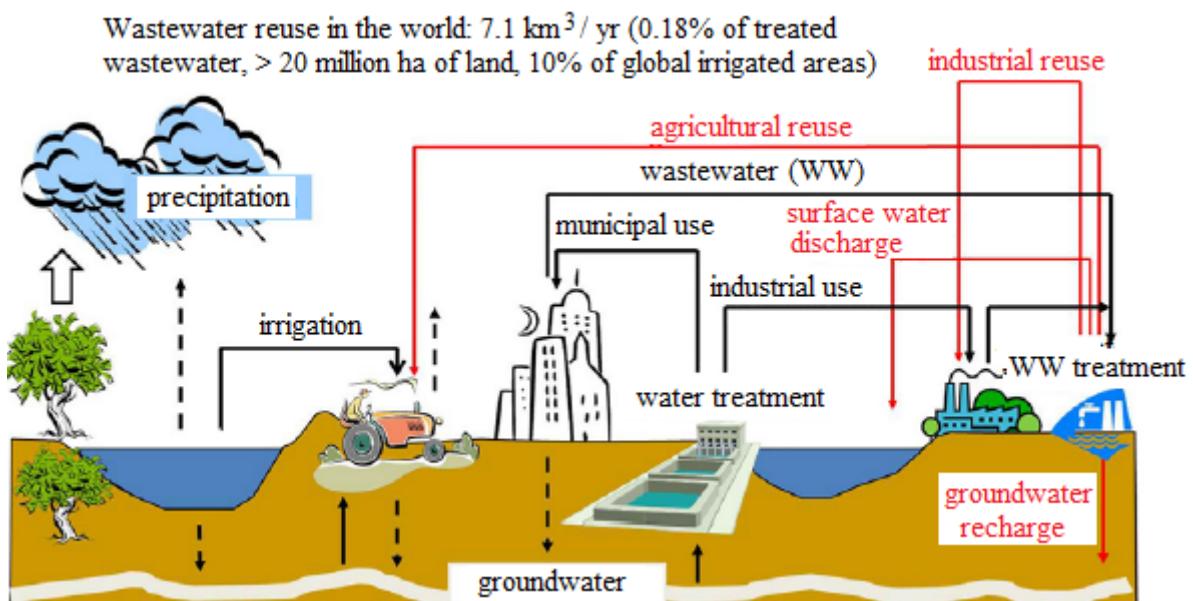

Figure 1: Wastewater reuse and the hydrologic cycle [22]

Conventionally, the rational utilization of wastewater in rural areas, together with the protection of the environment, can be made after at least partial purification, ideally complete (primary and secondary treatment). Choosing of the treatment method is influenced not only by the polluting load of wastewater, the technological possibilities and costs of water treatment, but also by the particularities of agricultural crop to be irrigated.

In developed countries, the reuse of municipal wastewater is normally based on the upgrade of existing wastewater treatment plants (WWTP) with the introduction of tertiary treatments. Several pilot studies and full scale installations have shown that a number of different technologies are suitable for producing reclaimed municipal effluents complying with the standards for reuse [18]. The quality of treated wastewater depends to a great extent on the quality of the municipal water supply, nature of the wastes added during use and the degree of treatment the wastewater has received [12]. Also, high quality effluent requires water treatment shift from less developed methods toward advance methods that imply higher costs.

The wastewater treatment plants (WWTP) are designed to decrease the environmental impacts of municipal and industrial discharges. In addition to the mandatory primary and secondary treatments, in the last decades the WWTP completed their facilities with advanced (tertiary) treatment, facilitating the wastewater recycling and reuse. Figure 2 presents the types and levels of wastewater treatment processes that are currently applied in most regions of the world [19].

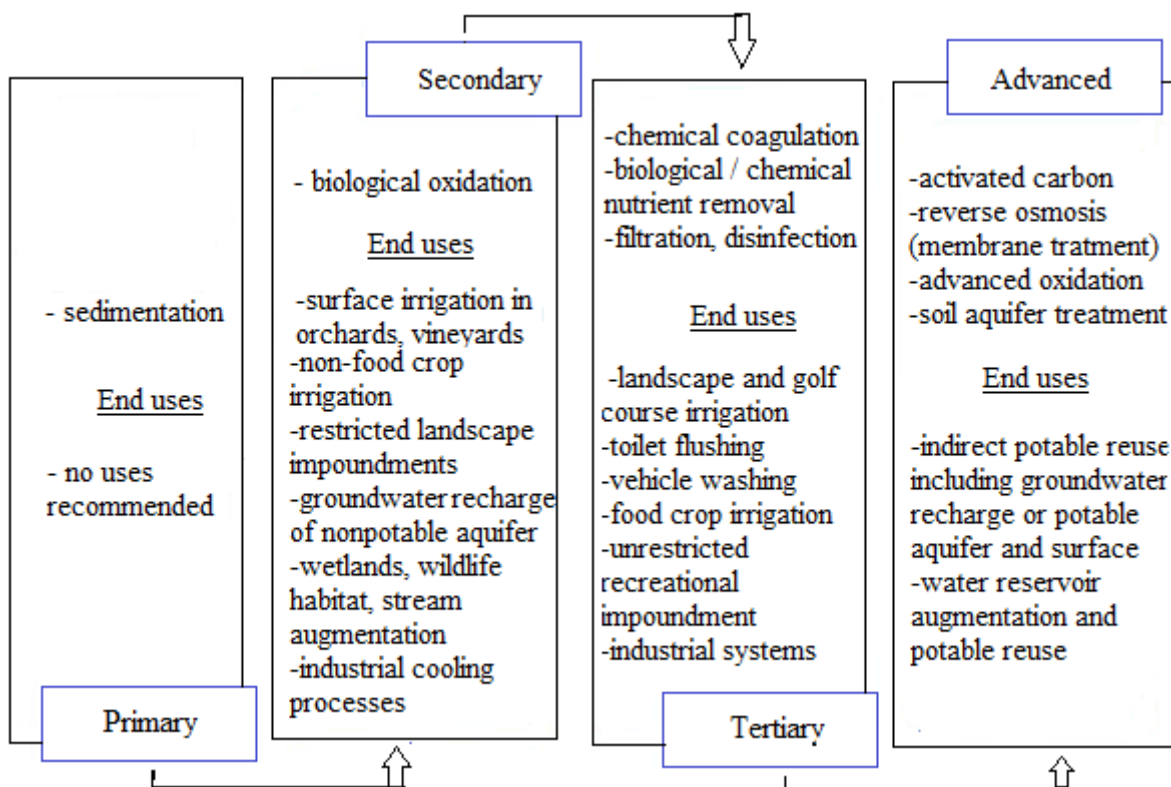

Figure 2: Types and levels of wastewater treatment processes [19]

However, there cannot be a single design solution for a WWTP that produces quality effluent for irrigation, as there are wide differences between locations, not only in climate and physical environment, but also in social acceptance, economic and technical opportunities and perceptions related to the use of treated and untreated wastewater [5].

In agriculture, special attention must be paid to ensure the safe use of wastewater to irrigate vegetable crops, mainly because of the potential chemical and microbiological contamination.

In most literature studies, the suitability of treated municipal wastewaters for irrigation is mainly based on salinity and pathogen removal. Only few studies make a complete evaluation of the suitability of produced effluent for irrigation taking all four main parameters into account, and include constructed wetlands and integrated systems, which include successive treatment steps using MBR, gravel filter, granulated ferric hydroxide absorber for heavy metals and UV [11].

The reuse of tertiary wastewater is encouraged as a general principle, although the actual laws do not differentiate the wastewater according to the risk associated with the different types of reuse [1]. The irrigated energy crops are a typical case of a relatively low level of chemical and microbiological contamination risk because they do not require the same water quality than food crops.

The reuse of treated industrial wastewater in irrigation is rarely adopted, due to the potential hazard of non-biodegradable compounds that may be present in these streams, depending on their origin. However, treated agro-industrial effluents may be considered for reuse, due to relatively steady composition (depending on the industrial processes) and more limited microbiological contamination with respect to municipal sewage [18]. Recovery and reuse of agro-industrial effluents is especially relevant in Southern European countries, where the economy is strongly based on irrigated agriculture.

Salinity, pathogens, nutrients and heavy metals are the main parameters considered important for the quality of irrigation water. Irrigation of with low quality water, especially drip and subsurface irrigation, can potentially lead to contamination of groundwater when irrigation water contains high numbers of faecal microorganisms and pathogens, enteric viruses, and protozoa parasites [10].

Suitable irrigation methods can effectively mitigate negative environmental effects. Depending on the irrigation method used, flood irrigation can seriously pollute an entire field. For spray irrigation, wastewater at least meets secondary treatment standards of disinfection to reduce aerosol and health risks. Drip irrigation constitutes the most environmental friendly approach. Underground drip irrigation can mitigate environmental risks and can decrease nitrate leaching rates (reached 70%) [22].

### **3. CONCLUSIONS**

As a result of rapid population growth and industrialization with increased water demand, domestic and industrial wastewater amounts have increased considerably. In the same time, worldwide, due to climate change, the areas affected by drought and water scarcity are increasing daily with a concerning rate.

Wastewater, as a substitute for freshwater, contributes to agricultural irrigation to address the global water deficit. This nutrient-rich wastewater is viewed as a valuable resource to urban farmers seeking a consistently available source of irrigation water.

There is a considerable interest in the long-term effects of treated wastewater on crops intended for human consumption. Health and environmental aspects are very sensitive issues and important prerequisites, since wastewater effluent must not be used and/or accepted to replace conventional or possibly other non-conventional water sources for irrigation, unless it is adequately treated and safely applied.

### **ACKNOWLEDGEMENT**

This work has been funded by the Ministry of National Education and Research, through the UEFISCDI, within the project entitled „*Innovative technologies for crop irrigation in arid, semi-arid and sub-dry climate*“, contract no. 27 PCCDI / 2018.

## References

- [1] Alcalde-Sanz, L., Gawlik, B., *Water Reuse in Europe, relevant guidelines, needs for and barriers to innovation*, JRC Science and policy reports. EUR –Scientific and Technical Research series 2014.
- [2] Al-Hamaiedeh, H., Bino, M., *Effect of treated grey water reuse in irrigation on soil and plants*, *Desalination*, vol. 256 (1–3), pp. 115–119, 2010.
- [3] Almuktar, S.A.A.A.N., Abed, S.N., Scholz, M., *Recycling of domestic wastewater treated by vertical-flow wetlands for irrigation of two consecutive Capsicum annum generations*, *Ecological Environment*, vol. 107, pp. 82–98, 2017.
- [4] Becerra-Castro, C., Lopes, A.R., Vaz-Moreira, I., Silva, E.I., Manaia, C.M., Nunes, O.C., *Wastewater reuse in irrigation: a microbiological perspective on implications in soil fertility and human and environmental health*, *Environment International*, vol. 75, pp. 117–135, 2015.
- [5] Cakmak, B., Apaydin, H., *Review. Advances in the management of the wastewater in Turkey: natural treatments or constructed wetlands*, *Spanish Journal of Agricultural Research*, vol. 8(1), pp. 188–201, 2010.
- [6] Corcoran, E., Nellemann, C., Baker, E., Bos, R., Osborn, D., Savelli, H., *Sick Water? the Central Role of Wastewater Management in Sustainable Development. A Rapid Response Assessment*, United Nations Environment Programme, UN-HABITAT, GRID-Arendal, Norway 2010.
- [7] Elgallal, M., Fletcher, L., Evans, B., *Assessment of potential risks associated with chemicals in wastewater used for irrigation in arid and semiarid zones: a review*, *Agricultural Water Management*, vol. 177, pp. 419–431, 2016.
- [8] EU-level instruments on water reuse. Final report to support the Commission’s Impact Assessment. Luxembourg: Publications Office of the European Union, 2016.
- [9] FAO, *Coping with water scarcity. An action framework for agriculture and food security*, FAO Water Reports. Food and Agriculture Organization of the United Nations (FAO), Rome 2012.
- [10] Lonigro, A., Rubino, P., Lacasella, V., Montemurro, N., *Faecal pollution on vegetables and soil drip irrigated with treated municipal wastewaters*, *Agricultural Water Management*, vol. 174, pp. 66–73, 2016.
- [11] Norton-Brandao, D., Scherrenberg, S.M., van Lier, J.B., *Reclamation of used urban waters for irrigation purposes – a review of treatment technologies*, *J. Environ. Manage.*, vol. 122, pp. 85–98, 2013.
- [12] Pedrero, F., Kalavrouziotis, I., Alarcon, J.J., Koukoulakis, P., Asano, T., *Use of treated municipal wastewater in irrigated agriculture – review of some practices in Spain and Greece*, *Agricultural Water Management*, vol. 97, pp. 1233–1241, 2010.
- [13] Qadir, M., Wichelns, D., Raschid-Sally, L., Minhas, P.S., Drechsel, P., Bahri, A., McKornick, P., *Agricultural use of marginal quality water - opportunities and challenges*. In: D. Molden (Ed.), *Water for Food, Water and life: A Comprehensive Assessment of Water Management in Agriculture*, Earthscan, London, 2007.
- [14] Qadir, M., Wichelns, D., Raschid-Sally, L., McCornick, P.G., Drechsel, P., Bahri, A., Minhas, P.S., *The challenges of wastewater irrigation in developing countries*, *Agricultural Water Management*, vol. 97, pp. 561–568, 2010.
- [15] Sato, T., Qadir, M., Yamamoto, S., Endo, T., Zahoor, A., *Global, regional, and country level need for data on wastewater generation, treatment, and use*, *Agric. Water. Manag.*, vol. 130, pp. 1–13, 2013.
- [16] Shakir, E., Zahraw, Z., Al-Obaidy, A.H.M.J., *Environmental and health risks associated with reuse of wastewater for irrigation*, *Egyptian Journal of Petroleum*, vol. 26, pp. 95–102, 2017.
- [17] Shetty S, *Treated wastewater use in Tunisia: lessons learned and the road ahead*, International Water Management Institute (IWMI), India 2004.
- [18] Vergine, P., Saleron, C., Libutti, A., Beneduce, L., Gatta, G., Berardi, G., Pollice, A., *Closing the water cycle in the agro-industrial sector by reusing treated wastewater for irrigation*, *Journal of Cleaner Production*, vol. 164, pp. 587–596, 2017.
- [19] Vo, P.T., Ngo, H.H., Guo, W., Zhou, J.L., Nguyen, P.D., Listowski, A., Wang, X.C., *A mini-review on the impacts of climate change on wastewater reclamation and reuse*, *Sci. Total Environ.*, vol. 494, pp. 9–17, 2014.
- [20] WHO, *Guidelines for the Safe Use of Wastewater, Excreta and Greywater*, vol. 2. World Health Organization (WHO), France 2006.
- [21] Xu, M., Bai, X., Pei, L., Pan, H., *A research on application of water treatment technology for reclaimed water irrigation*, *International Journal of Hydrogen Energy*, vol. 41, pp. 15930–15937, 2016.
- [22] Zhang, Y., Shen, Y., *Wastewater irrigation: past, present, and future*, Wiley Periodicals, Inc, WIREs Water, pp. 1–6, 2017.

# STUDY CONCERNING TECHNOLOGIES FOR OBTAINING OIL FROM GRAPE SEEDS

Ph.D. Stud. Eng. Carmen Vasilachi, Prof.Ph.D.Eng. Sorin-Stefan Biriş  
University "Politehnica" Bucharest, Faculty of Biotechnical Systems Engineering/Romania  
Tel: 0760746566; E-mail: [carmen.vasilachi@gmail.com](mailto:carmen.vasilachi@gmail.com)

## ABSTRACT

A large volume of winery wastes remain unexploited every year on an international level, even though the grape production is considered to be one of the most important agro-economic activities worldwide. Taking into consideration the rapid growth of technology of the past few years, it is easier nowadays to extract raw materials from the waste that resulted out of the technological processes of obtaining wine.

The purpose of this study is to raise awareness and to encourage the reduction of the waste impact, waste that is produced in the winery through mechanical and chemical extraction technologies in order to obtain grape seed oil. It is also common knowledge that due to its high vitamin E content, grape oil is widely used in cosmetic and pharmaceutical products because of its beneficial effects on the skin and hair.

## 1. INTRODUCTION

Grape seed oil has a large scale applicability, being used in numerous fields starting with cosmetics and ending all the way up to cooking. Grapes seeds contain approximately 14 to 20% oil. The grape seed oil is abundant in linoleic acid (approximately 65 to 72%), oleic acid (approximately 12 to 23%), palmitic acid (approximately 4 to 11%), stearic acid (approximately 8,5 to 15%). The linoleic acid which can be found in grape seed oil plays an important role as it cannot be synthesized by the body itself and this is why products which contain it have a very significant nutritional value. As corresponding recommendations throughout the following type of seed oils linoleic acid can be found in: sunflower oil, soybean oil, safflower oil-safflower oil (a plant which is a family member of sunflower plant family) seed oil, corn oil and oil from poppy seeds. The oleic acid is also an important contributor to the nutritional value of the oil as it affects the oxidative stability of oils [1,2,3].

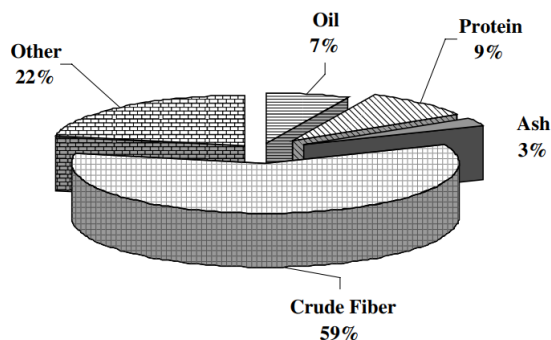

Figure 1: Approximate composition of a grape seeds [5]



Current studies show that the amount of seeds present in grapes can vary between one and four units. Also according to Matthäus (2008), in 100 kg of wet residue produced by industry there is close to 10 till 12 kg of seeds that can be obtained. The lipid content of the grape seed is around 7 to 20%. In addition to this, there are also close to 35% fibre content, 9 to 11% protein content, 3% minerals content and a remaining of 7% water content [4]. The minor compounds concentration is variable and is dependent on the technological processing which are to be performed and many other environmental cultivation conditions.

Beneficial effects that result out of the seed extracts[4]:

- the modulation of the antioxidant enzymes expression;
- protection against oxidative damage that occurs inside the brain cells of rats;
- reducing atherosclerosis in hamster subjects;
- anti-inflammatory effects.

The grape seed has a considerable amount of phenolic compounds (around 60 to 70% of the total minority compounds found in the grape seed's oils), amount which can be found in smaller percentages in other parts of the fruit, such as in it's peels (approximately 28 to 35%), and also even lower amounts can be found in the pulp (approximately 10%) [4].

The processing routes and the derived products obtained from grape seeds are detailed in the below presented Fig.2. As an example the grape seed oil is being used as an ingredient in the cosmetics industry for treating damaged and stressed tissues, for the possession of regenerative properties and restructuring qualities which allow a better control for an advanced skin moisturization and protection [9].

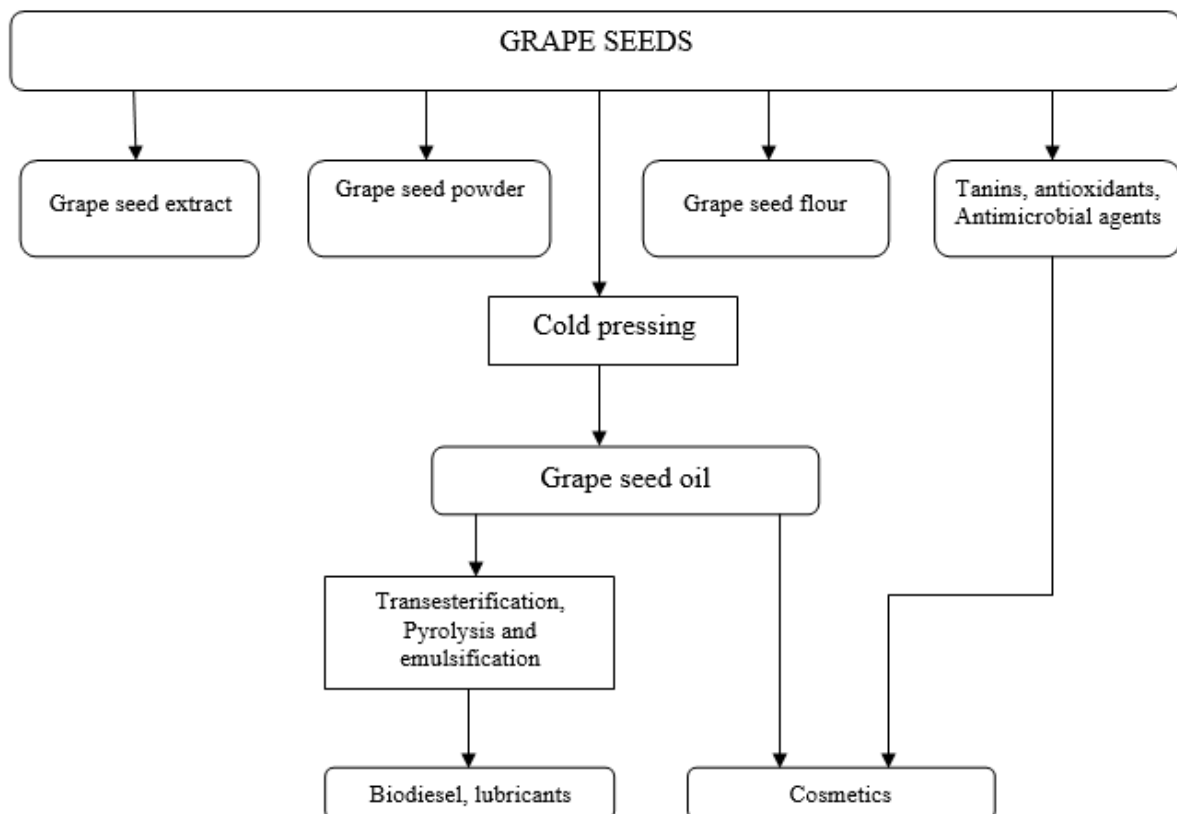

Figure 2: Processing routes and the derived products obtained from grape seeds

The chosen method for oil extraction depends on the nature of raw material. The traditional way used for extracting grape seed oil is through the cold pressing method in which the whole seeds are put in discontinuous hydraulic presses or they are milled and heated in a screw press. It is an important matter that the seed's moisture percentage won't exceed 10% [3]. The cold pressing extraction method is a mild process that facilitates obtaining a good quality of oil.

After recent developments alternative methods are being suggested to obtain grape seed oil, without the presence of organic solvents, like hot water extraction, supercritical fluid extraction (SFE), supercritical CO<sub>2</sub> extraction, pressurized liquid extraction (PLE) and ultrasound assisted extraction.

## 2. METHODOLOGY

There are two different ways of obtaining grape seed oil that are presented in these studies and these are as follows: the cold pressing method and the extraction with supercritical carbon dioxide. Several other methods can be used to obtain grape seed oil, as they can be seen presented in Figure 3 [11].

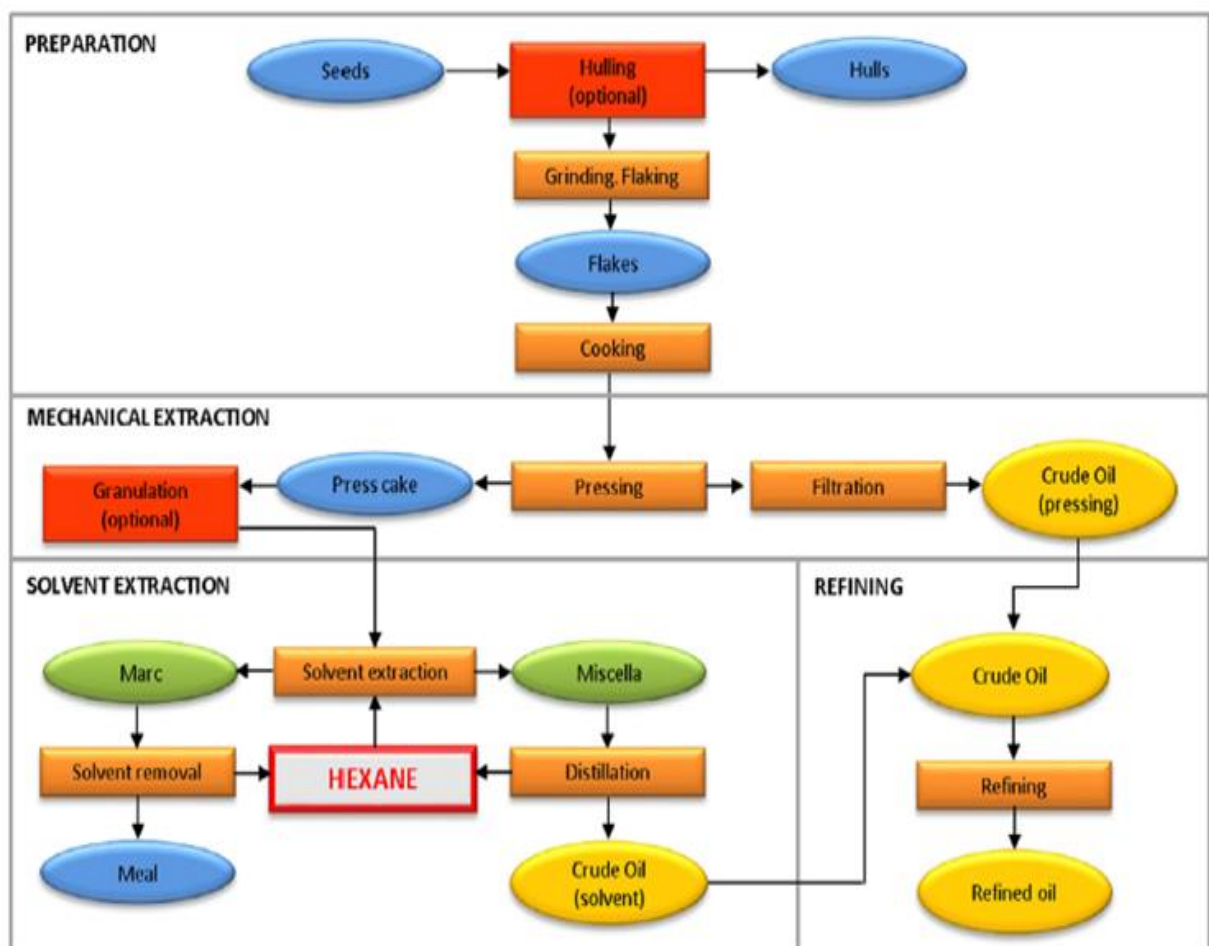

Figure 3: Processing procedures for grape seed oil extraction

Expression or cold pressing is the oldest extraction method known to be used in such circumstances and is known to be used almost exclusively for the production of oil. This method

refers to any physical process during which the grape seed oil glands located in the peel and cuticles are broken in order for the oil to be released and extracted. This process results in the production of a watery emulsion, which is subsequently centrifuged or filtrated in order to separate out the grape seed oil from the remaining waste[10].

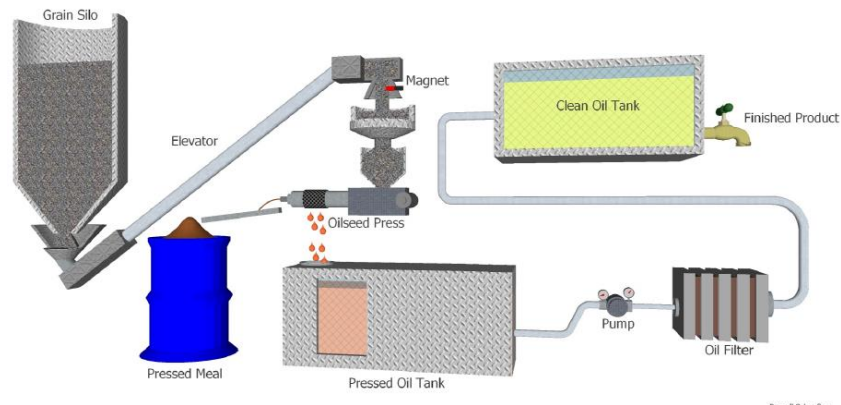

Figure 4: Small scale oilseed pressing process[6]

From the funnel which contains the high and low switches, the seed is fed into the hopper of the expeller press (Figure 4). The press is a crucial part of the system, as it is the functioning part which does the extraction of the oil from the seed. An expeller press is composed of several functional components. Starting with the hopper, the seed is fed into the barrel, into which a screw turns slowly. The screw pushes the seed forward, where it is then crushed, squeezing the oil back into the barrel, into where it drips through a series of small holes and where it is collected. The crushed seed is then compacted and extruded through and out the press head, where it is also stored. The extruded pulp also known as the meal, has multiple sets of uses. The meal is commonly used as feed for livestock, as it is high in protein. It can also be used by turning it into pellets and using them as a source of fuel for stoves. The pellets which composed of meal burn at high temperature and provide heating for homes and other buildings, or it can be used under other circumstances as a fuel source. The meal can also be converted and used as an organic fertilizer. The expeller press does not remove the entire oil from the meal; thus the amount which is extracted depends on the press's various settings possibilities. The expeller presses usually have adjustable tip diameters and a variable speed drive.



Figure 5: Grape speed oil press Komet D85-1G

The Komet Vegetable Oil (Figure 5) expellers feature a special cold pressing system with a single conveying screw instead of individual compression screws, to squeeze the oils out of the grape seeds. The oil presses operate on a gentle mechanical press principle, which does not involve mixing and tearing of the seeds. A further advantage of this system is that virtually all of the oil bearing seeds, nuts and kernels can be pressed with the standard equipment of the press without cumbersome adjustment of screws and oil outlet holes. Another advantage of this

system is that the press cake (remains) extrudes out of the oil press in the shape of pellets that are easy to store and handle [12].

The utilization of the supercritical technology to extract oil seems economically justified when obtaining an added-value final product such as how the grape seed oil could be enriched in poly-unsaturated fatty acids. Actually, the case is that the supercritical extraction process could be coupled to a partial fractionation of the extracted matter based on the different solubility of the oil constituents.

For extracting oil from grape seeds with the help of the supercritical carbon dioxide method the seeds need to be washed and oven-dried at 55°C for 4 to 6 h. After all of that is completed then they need to be grinded using a mill and then sieved using a sieve screens that has the gap diameter between 10 and 100 mesh. The grinded seeds samples of particle sizes are ranging between 0.15 to 2.0 mm.[8].

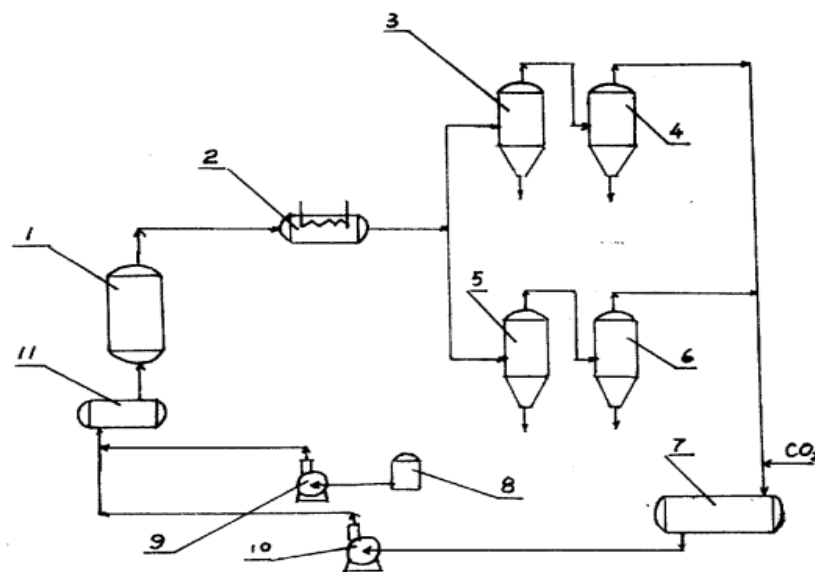

Figure 5: Supercritical carbon dioxide oil extraction process from grape seeds [9]

Embodiments of the invention are as follows: (see Figure 5). The technical process of oil extraction is made up of two steps: a first step, grape seed extract. Wash dried and pulverized to a particle size of 20 to 40 mesh grape seed enter the cartridge into the extraction vessel 1 to open the high-pressure pump 10 and draw in fresh CO<sub>2</sub> enters into the condenser 7 through the high pressure pump 10 after the preheater 11 and into the to the extraction vessel 1, the control pressure within the extraction vessel 1 has to be set to  $27 \pm 2$  Mpa, the temperature 60 °C, for about 2 to 4 hours of extraction, the condenser temperature was 7 °C, the extract stream through the heater 2 is heated to 65 °C, into two series grapesed oil is then collected within the separator (3,4), then stream 7 through the condenser is circulated.

Step Two: anthocyanin original re-extracted oligomers. Modifier actuated pump 9 after 2 to 4 hours of extraction, the modifying agent in the modifying agent tank 8, i.e. acetone: water in the proportion of 70:30 as a modifier also enters the preheater 11, through the control of grape seed extract than the oil stream with a modifying agent was 4 to 22-25Mpa of pressure, a temperature of 60 °C, after the extraction the process of injection through the heater into another set of two separators in series after 2 (5,6 ) in order to start separating the procyanidin oligomers[13].

### 3. CONCLUSIONS

Our preliminary study indicates and sustain that the extraction with supercritical carbon dioxide technique may certainly be used to enhance oil extraction in comparison with pressing.

The advantage of the extraction through supercritical carbon dioxide is that the process is simple and reliable, grape seed oil has a purity of 97% or more yield of 15%, the purity of procyanidin oligomers are up to more than 95%, the yield is up to 14%.

Also, both methods could be used together for a good extraction and yield.

### References

- [1] Jaromír Lachman, Alena Hejtmankova, Jan Taborský, Zora Kotíková, Vladimír Pivec , Radomíra Stralkova, Alena Vollmannova, Tatiana Bojnanska, Martin Dedina, *Evaluation of oil content and fatty acid composition in the seed of grapevine varieties*, LWT - Food Science and Technology, 2015
- [2] JAKOBOVIĆ, Stela JOKIĆ, Snježana JAKOBOVIĆ, Darko KIŠ, *Utilization of winery by-products into high added value products – grape seed oil and defatted meal*, Polytechnic in Pozega, Croatia, 2016
- [3] Evangelia I. Sotiropoulou. V. Varelas, M. Liouni, E. T. Nerantzis, *GRAPE SEED OIL: FROM A WINERY WASTE TO A VALUE ADDED COSMETIC PRODUCT-A REVIEW*, Laboratory of Industrial Chemistry, Dept. of Chemistry, University of Athens, Greece 2015
- [4] Fernanda Branco SHINAGAWA, Fernanda Carvalho de SANTANA, Lucillia Rabelo Oliveira TORRES, Jorge MANCINI-FILHO, *Grape seed oil: a potential functional food?*, Universidade de São Paulo – USP, São Paulo, SP, Brazil, 2015
- [5] Tobar P., Moure A., Soto C., Chamy R., Zuniga M.E.: Winery solid residue revalorization into oil and antioxidant with nutraceutical properties by an enzyme assisted process. *Water Science and Technology*. 51, 47-52, 2005.
- [6] Douglas Schaufler, *Small-scale Oilseed Processing Guide*, University of Vermont, 2013.
- [7] Duba, K. S, Fiori, L.: Supercritical CO<sub>2</sub> extraction of grape seed oil: Effect of process parameters on the extraction kinetics. *The Journal of Supercritical Fluids*. 98, 33-43 (2015).
- [8] Jirawat Eiamwat, Paramee Pengpreecha, Benjaporn Tiensong, Sorada Walapa, Kulapatr Wachirasiri, and Sukit Kampruengdet, *EXTRACTION OF OIL FROM GRAPE SEEDS WITH SUPERCRITICAL CARBON DIOXIDE*, Food technology department, Thailand Institute of Scientific and Technological Research, Thailand 2013
- [9] Nerantzis, E., Tataridis, P., *Integrated Enology- Utilization of winery by-products into high added value products*, e-Journal of Science & Technology (e-JST), No. 3, 2006.
- [10] Victor R. Preedy, *Essential oil in food preservation, flavor and safety*, Department of Nutrition and Dietetics, London, UK, 2016.
- [11] Anne-Gaëlle Sicaire, Maryline Abert Vian, Frédéric Fine, Patrick Carré, Sylvain Tostain, Farid Chemat, *Ultrasound induced green solvent extraction of oil from oleaginous seeds*, Université d'Avignon et des Pays de Vaucluse, INRA, UMR408, GREEN Extraction Team, 84000 Avignon, France, 2016
- [12] <http://www.oekotec.ibg-monforts.de/index.php/en/oil-presses/oil-press-d85-1g>
- [13] *Supercritical carbon dioxide extraction process of grape seed oil and cyanine oligomer*, patents CN1241623A

# RURAL POLICIES IN ROMANIA PRIOR AND AFTER EUROPE 2020

Oana Vlăduț<sup>1</sup>, Petruța Mihai<sup>2</sup>, Mihaela-Florentina Duțu<sup>3</sup>, Iulian-Claudiu Duțu<sup>4</sup>, Daniel-Ion Vlăduț<sup>5</sup>  
University Politehnica of Bucharest

## ABSTRACT

Romania's accession to the European Union in 2007 also involved the adaptation of our country's policies in all areas to the requirements of the European community. Considering the importance of the natural environment, with all its components, policies in this area have become priorities for institutions working in the environmental field. The rural environment has been given special attention, so the paper aims at briefly presenting the evolution of rural policies, from Romania's accession to the European Union, as well as in the perspective of the years to come.

## 1. INTRODUCTION

The Romanian rural space benefits from a significant potential for development, yet still not capitalized on, as it is not paid the due attention to, while considering that almost 50% of the Romanian population lives in the rural areas and these areas take up to circa 90% of the total surface area of the country. The analysis of the implementation of the rural development measures is rather essential, as well as the examination of their effects upon the development of the rural space.

Romania has a valuable potential of development, but still poorly used. At the regional level, a balanced distribution of the territory among the 6 regions can be noticed (14.33% NW, 14.30% Center, 15.46% NE, 15% SE, 14.45% S-Muntenia, 12.25% SW-Oltenia, 13.44% W), while Bucharest-Ilfov only takes 0.76% of the territory. In terms of geographical areas (mountains, hills and fields), the territory is distributed in relatively balanced percentages, with the rural areas having considerable resources for development.

The rural population is not evenly distributed, as it has a high percentage in certain regions (S-Muntenia – 58.6%, NE – 56.8% and SV Oltenia – 51.9%), excepting Bucharest-Ilfov. Such disparities have an impact upon the social and economic development of the areas and the life quality of the rural population.[4] This population witnesses a demographic decline, as it is continuously lowering in number and aging.

## 2. PAPER CONTAIN

The new philosophy of the rural space development is based on the concept of durable rural development, which involves the harmonious conjunction between the component of the agricultural and forestry component and the one pertinent of the non-agricultural rural economy, grounded on the following principles:

- harmonization between the rural economy and the environment;
- durable development programs need to include a medium and long time horizons;
- greening of the rural space by maintaining the natural environment as untouched as possible;

---

<sup>1</sup> Splaiul Independentei nr.313, sector 6, Bucharest and oanavlادت2016@gmail.com

<sup>2</sup> Splaiul Independentei nr.313, sector 6, Bucharest and mihaipetruta@yahoo.com

<sup>3</sup> Splaiul Independentei nr.313, sector 6, Bucharest and dutumihaelaflorentina@gmail.com

<sup>4</sup> Splaiul Independentei nr.313, sector 6, Bucharest and iulian\_claudiu.dutu@upb.ro

<sup>5</sup> Splaiul Independentei nr.313, sector 6, Bucharest and v\_vladuta@yahoo.com

- anthropized environment should be the closest possible to the natural environment;
- use of the local natural resources in the rural economic activity, with a priority of the renewable resources;
- diversification by pluriactivity of the agricultural economy structure, through extension of the agro-food, of the non-agricultural economies and services.

The strategy of rural development of Romania for the following years is aligned with the context of reform and development that the EU intends to comply with, as per Europe 2020 strategy, which is the advancement strategy of the European Union for 2010-2020.

The National Rural Development Program (NRDP) for 2014-2020 contributes to a smart development by supporting the partnership among the research area, agricultural workers and other actors of the rural economy, and also by assistance of the professional training, acquisition of competences and information dissemination.[2]

NRDP also considers a durable development that is focused on the lowering of the carbon emission caps and on aid provided to the environment-friendly agricultural practices. Last but not least, the assistance given to the investments in the rural infrastructure and economy leads to less poverty and creating employment in the rural areas, thus contributing to an evolution favorable to inclusion.

The agricultural sector and the rural economy generally have a sizable growth potential, still underutilized.

The business development at a small scale is an important source of employment and, implicitly, of earnings. Among the active SMEs of a non-agricultural nature, a low number shows in the rural sector, which confirms their low percentage in conducting such activities (industry, services and rural tourism). The analysis of the SMEs in the rural sector proves their poor ability to create employment for population.

In spite of the fact that the micro-enterprises operating non-agricultural activities in the rural sector were also sustained through NRDP 2007-2013, the density of the SMEs is much lower than nationwide.[1] In regards to the tourism infrastructure, the accommodation capacity has recorded an increase, mainly for the agro-tourism boarding houses, thanks to the assistance provided by the European Agricultural Fund for Rural Development.

Nevertheless, the rural tourism has not reached a satisfactory level in terms of quality of the infrastructure of support and services, mainly recreation, since the access of the SMEs to financing is rather precarious. As for territoriality, the enterprises in the rural and agricultural sectors find it difficult to access the financial services, due to the high financing fees. Although there were financial mechanisms, eg guarantee funds, some beneficiaries who signed financing agreements in NRDP 2007 – 2013 were not able to access credits for investments, since there was not a loan type adjusted to the agricultural context.

The main difficulties in carrying out the projects for the basic infrastructure, mainly integrated, were: a high level of complexity (including the inadequate understanding of the concept of integrated project), the long duration of the execution, the lack of clear regulations, along with the impossibility of the beneficiaries to support the investment until its final stages. The investments required obtaining a large number of permits issued by different authorities, which slowed down the implementation. The basic services do not respond to the needs of the rural population, and the deficit of the conditions for the development of the rural space from a social perspective has a negative effect upon the economic evolution of such areas in Romania.

The reduction in the number of shops for services and of the handmade cooperative units has triggered a severe cutback of the social economy in the rural sector.

The early childhood and preschool education (kindergartens) are facing a major deficit in terms of infrastructure. The cultural identity of the Romanian village is an essential source of local development, described by a varied cultural, tangible and intangible heritage. In the rural area, the access of the inhabitants in villages and communes to culture is rather limited, in

comparison with the urban area. The cultural heritage in the rural regions shows a high level of deterioration, which calls for investments required for its reclaim. The monastery sites are an integrant part of the cultural heritage in Romania. Their purpose is in fact the preservation of the national identity and tradition through craft practices, culinary, agricultural customs and conservation of the architectural styles that are specific to the respective areas.

The 2020 digital agenda foresees a minimum level of 30 Mbps versus the expected 1-4 Mbps speed. At the end of first semester in 2014, 15.5% of the total of broadband connections in the rural area represents connections at higher speeds or equal with 30 Mbps.[5] For Romania, it is only 42% of the households that have internet connection and 23% accessing the broadband. This unsatisfactory rate of penetration in the rural regions derives from low income, lack of personal computers, poor DSL (Digital Subscriber Line) coverage conditions. The wireless internet is almost inexistent.

The natural environment in Romania is described by a good preservation state of the natural resources of soil and water, by a variety in the traditional landscape and a remarkable biological diversity. A part of the resources is subjected to certain pressure factors, with an impact upon the environment value and on their fruitful potential from a quantity and quality perspective. In terms of the biological diversity, Romania is the most important countries in the European Union, since it hosts the largest number of bio-geographical regions herein.

The fresh water resources of our country are few and unevenly distributed, thus placing Romania in the category of the countries with scarce water resources.[3] The national strategy and policy in the water management aims towards a durable water administration as in line with the EU directives, including the following specific objectives:

- improvement in the surface and underground waters through implementing the management plans of the current water catchment areas, in accordance with the Water Framework Directive of EU;
- implementation of the National Flood Risk Management Strategy and carrying out the specific measures, in line with the Flood Directive;
- drafting the Guidelines for Water Catchment Areas Development for the water use, in order to reduce the negative effects of the natural phenomena;
- implementation of the Plan of protection and rehabilitation of the Romanian Black Sea Shore, including the stipulations in the „Protection and rehabilitation of the coastal area” master plan;
- consolidating the cross-border and international partnership, in order to monitor the implementation degree of the international agreements and promotion of the joint project.

The disadvantaged areas hold a significant percentage in the total surface area of our country, since they have unfavorable environment characteristics as a result of certain biological and physical factors (climate, edaphic, landscape) that bring a limitation to the usual agricultural activity by obtaining low production, short vegetation period, increase in the production costs, etc.

By 2020, Romania must have 24% in the energy derived from renewable sources in agriculture, out of final gross energy consumption, where the biomass covers circa 50% of the potential of renewable sources in the country agriculture. The production and use of the energy coming from renewable sources in agriculture are low – 2.5% of the total production came from agriculture in 2011, compared to 9.8% in the EU. On the other hand, circa 69.1% in the renewable energy at the national level in 2011 resulted from the forestry sector, versus 48.3% in the EU 27.



### 3. CONCLUSIONS

The research in Common Agricultural Policy starting in 2007, the year when Romania acceded to the European Union, has proven a continuity in its evolving implementation in agriculture and rural development, as the desired objectives and the measures taken to reach them are explicitly presented, as well as the necessary financial sources.

Between 2007 and 2013, Romania allotted to the farmers an average of 90 €/ha in the form of financial aid, by means of the single surface payment plan, thus placing itself on the antepenultimate place in the hierarchy of the new member states, with the last two places taken by Latvia and Estonia.

What is important for the support and development of the environment-friendly agricultural practices in constrained areas has been the financial aid for the farmers as direct payments within the National Rural Development Program 2007 – 2013 (Axis II, Measures 211, 212, 214) and NRDP 2014 – 2020 (Measures 10, 11, 13, 15).

To increase the attraction level of the funds meant for the rural development, the responsible factors in Romania need to mainly focus on the cash management quality. The major causes with negative effects in the absorption process of funds for the rural development are the lack of transparency, diminished experience, insufficient information, excessive bureaucracy, poor project management, frequent and last-moment changes in the guidelines of the measures, delays in signing the contracts, low possibility of providing the advance payment or covering the private contribution by the beneficiaries.

The measures taken to reduce poverty and to further the economic development in the rural area, including employment increase, should find a solution in expanding the financing level for the non-agricultural activities.

The requirements stipulated by the banking institutions to access the funds (for example guarantees) are similar to any other company or SME and difficult to meet. The too low specialization of the refund services has been visible in the credit guarantee systems for agriculture, as it has not been used as planned and, implicitly, in the limited accessing level of the program and in the increased rate of terminated projects among the selected beneficiaries.

### References

- [1] The Academy of Romania, *Strategia de dezvoltare durabilă pe termen mediu și lung a agriculturii și spațiului rural din România*, Bucharest, 2008.
- [2] Ministry of Agriculture and Rural Development, *Strategia de dezvoltare rurală a României 2014-2020*, Bucharest, 2013.
- [3] Németh Attila, *Analiza potențialului de dezvoltare rurală a Regiunilor Vest și Centru prin intermediul Politicii Agricole Comune*, PhD thesis, Cluj-Napoca, 2016.
- [4] <http://www.fonduri-ue.ro/pndr-2014>.
- [5] <http://www.fonduri-ue.ro/por-2014>.

# **SYSTEM FOR THE EXTRACTION OF BIOACTIVE COMPOUNDS FROM PLANTS WITH BIO-INSECTICIDE ACTION IN ORGANIC FARMING**

PhD. Eng. Voicea Iulian<sup>1)</sup>, PhD. Stud. Eng. Găgeanu Iuliana<sup>1)</sup>, PhD. Stud. Eng. Cujbescu Dan<sup>1)</sup>, PhD. Stud. Eng. Persu Cătălin<sup>1)</sup>, Eng. Bălan Vică<sup>2)</sup>, Eng. Săvoiu Lucian<sup>3)</sup>

<sup>1)</sup>INMA Bucharest, <sup>2)</sup>Mido Rom Electronic SRL, <sup>3)</sup>Agricola Medicinale 2000

## **ABSTRACT**

Organic agriculture promotes sustainable, diversified and balanced production systems, in the view of preventing crop and environment pollution.. The discovery of these new compounds is possible by studying various plant extracts obtained through extraction processes from the variety of plants available on the earth's surface. Within the paper, for obtaining compounds with bio-insecticide action, an extraction experimental model – EXTBIO was developed, operating on the principle of extracting bioactive substances under the action of variable hydrostatic pressure in the extraction chamber, controlling solvent temperature. For an optimal control of the extraction process, a micro-PLC with graphic interface is used, through which the working parameters can be programmed. Hydrostatic pressure in the extraction chamber is obtained through the means of a pneumatic cylinder fed with compressed air from a compressor integrated in the equipment.

## **1. INTRODUCTION**

Organic agriculture can be defined as a production system that avoids or widely excludes the use of synthetically composed fertilizers, growth regulator and additives in animal nutrition. Organic agriculture systems are based on crop rotation, on the use of crop residues, animal dejections, manure, organic waste from outside the farm, [1]. Organic agriculture has a positive contribution in a variety of fields, contributing to the preservation of soil structure, earthworms, microorganisms, insects, to soil and environment protection. The number and diversity of organisations within the organic movement reflecting internationally, both in terms of number as well as in terms of opinions that differ in an obvious manner, are renowned in IFOAM (International Federation of Organic Agriculture Movement). IFOAM establishes the base standards that will be adopted by national organizations and monitors these national standards for allowing participation in international trade. The idea situated at the basis of organic agriculture arose in the year 1920, and after it evolved considerably and continues to evolve as new scientific researches become available, but still retains the fundamental philosophical perspective to work with natural systems and to respect the environment supporting us all, [2]. The organic movement announces a change in agriculture that appears simultaneously in any developed agricultural nation in the world. Organic agriculture is far from being a return to the past, wanting to be an agriculture for the future.

---

<sup>1</sup> 6, Ion Ionescu de la Brad Blvd, e-mail: [voicea\\_iulian@yahoo.com](mailto:voicea_iulian@yahoo.com)

Insects react to smell, vapours, gases, smoke, heat, oils, soap, etc., and organic insecticides take into consideration all these aspects. For example, strong smell of garlic, tobacco, rhubarb and other plants has a repellent effect on insects. Hot peppers, alcohol, salt and other substances can burn or destroy pests. Oils suffocate certain insects, and soap or detergents added to mixtures have the role of making the substances of the solution to stick to leaves and stalks, [3].

Along with the highly increasing organic demands worldwide, were elaborated technologies for the submerged cultivation of microorganisms and technologies for extracting bioactive substances with biofertilization role. Out of the bio-mixtures used for soil fertilization, we name *Azotobacterin* containing bacteria in the genus *Azotobacter chroococcum* stimulating cellulolytic development. *Fosfobacterin* is a bio-mixture containing *Bacillus megaterium var phosphoaticus* bacteria and exerts a stimulating action on bacteria fixing nitrogen.

The success of using the microbial mixtures in stimulating plant growth and protection depends on the form of the mixture, which is achieved in the following manners:

- powders– mixture of microbial biomass with addition of substances (talc, kaolin, bentonite, etc.);
- humidifying powders – suspensions with water;
- Granular mixtures – biomass-soaked granules granule;
- Water plant solutions and extracts, hydro alcoholic extracts, [4].

In the field of microbial fertilizers and extracts with bioactive substances with biofertilization role, a major problem is constituted by the handling of plant microorganisms / extracts used in the agricultural field, their manner of transportation, preservation and use.

The participation of biofertilizers in the energy balance of agricultural crops has gained special importance, both due to their effect on the increase of agricultural production, as well as on the ecological effect they have on the atmosphere. The use of bio-mixtures for agricultural purposes, made on the basis of plant extracts with bioactive substances acting as biofertilizers by extraction from different medicinal, aromatic, cultivated or perennial plants, is an important orientation in the current agriculture due to the advantages they present, namely, [5]:

- Reducing pollution in the aquatic and terrestrial environment,
- Avoiding the emergence of pest populations resistant to phyto-sanitary treatments,
- Lack of secondary effects on humans and animals, etc.

Bio-mixtures / biofertilizers obtained based on bacteria / bioactive substances (extracts) actually have multiple action on crop plants, these complex actions are due to the specific biological character of products and is constituted in potential a useful resource, little acknowledged, and in consequence, little exploited right now.

Worldwide, the use of microbial mixtures / plant extract with biofertilization role for stimulating growth and crop plant protection, was made to a small extent, because some previous researches were finalized semi-industrially or industrially, [6].

Extracts obtained from medicinal plants can be classified by various criteria, as can be observed from table 1:

Table 1. Classification of extracts

No.	Classification criteria	Extract name
1.	By solvent nature	<ul style="list-style-type: none"> <li>• Water extract (by extracting active principles in water: macerates, infusions, decoctions)</li> </ul>

		<ul style="list-style-type: none"> <li>• Hydro alcoholic extract - tincture (extracts in various dilutions of ethylic alcohol)</li> <li>• Oil extract (obtained by extracting liposoluble principles in oil or other natural lipids)</li> <li>• Medicinal vinegars (macerated in vinegar) <ul style="list-style-type: none"> <li>▪ Medicinal wines (macerated in wine)</li> </ul> </li> </ul>
2.	By extraction method	<ul style="list-style-type: none"> <li>• Selective extract – obtained by eliminating compounds which do not make the object of selection (pure volatile oils – are obtained by entraining with water vapours: distillation, pharmaceutical products based on plants, obtained by neutralizing toxic substances)</li> <li>• Nonselective extracts (infusion, tinctures, macerates, decoctions, etc.)</li> <li>• Extract obtained by pressing or centrifugation (juice from leaves, fruits, vegetable)</li> </ul>
3.	By preparation method	<ul style="list-style-type: none"> <li>• Simple extract (obtained through a single operation)</li> <li>• Successive extract (obtained by repeating the same operation – homeopathic tinctures)</li> <li>• Multiple extract (obtained by applying multiple techniques for the raw material - macerate + infusion, infusion + decoction, etc.)</li> </ul>
4.	By the parts of the plant subjected to extraction	<ul style="list-style-type: none"> <li>• Partial extract (leaves, roots, aerial part)</li> <li>• Total extract (Whole plant)</li> </ul>
5.	By plant moisture	<ul style="list-style-type: none"> <li>• Extract obtained from the dried plant</li> <li>• Extract obtained from the fresh plant</li> </ul>

Solvent extraction is the most widely used type of extraction for bioactive compounds in plants. This separation technique involves the extraction of components from a solid or semi-solid sample in a suitable solvent. In the extraction operation, the choice of solvent is made depending on the nature of the substance to be extracted and on the nature of the feedstock, [7]. The actual solubilization of the bioactive compounds is achieved by treating the finely ground plants with water, saline solutions, hydro-alcoholic solutions, etc.

## 2. METHODOLOGY

Within INMA Bucharest was developed an **Experimental model for obtaining organic biofertilizers / bio-insecticides - EXTBIO**, which can be used in the purpose of obtaining plant bioactive extracts.

*The equipment for obtaining organic biofertilizers / bio-insecticides – EXTBIO* operates on the principle of extracting bioactive under the action of variable hydrostatic pressure in the extraction vessel, with solvent temperature control. In the purpose of achieving optimal control of the extraction process is used a microPLC with graphical interface, through the means of which is possible to program the working parameters. Hydrostatic pressure in the extraction chamber is obtained through the means of a pneumatic cylinder fed with compressed air coming from an compressor integrated in the equipment. All components are fitted of a frame formed by V shaped profiles.

The operational diagram of the equipment for obtaining organic biofertilizers / bio-insecticides – EXTBIO is presented in figure 1.

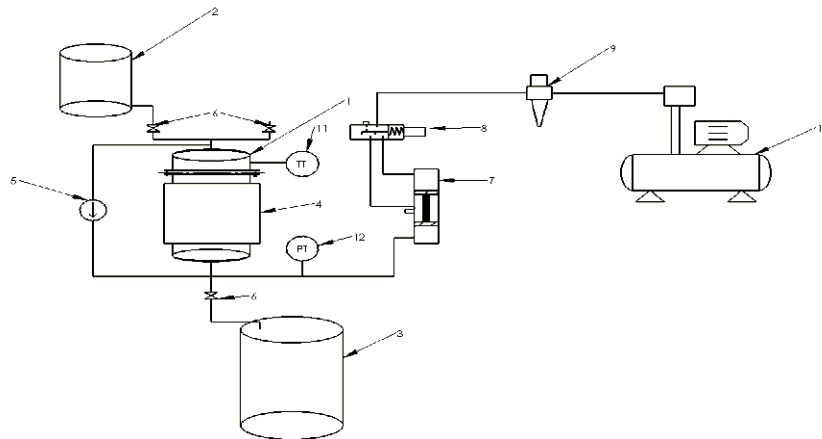

Figure 1. Principle diagram of the equipment for obtaining organic biofertilizers / bio-insecticides – EXTBIO (1-extraction vessel, 2-loading charging tank, 3 – final product unloading tank, 4-heating mantle with thermostat, 5-recirculation pump, 6-electro-valves, 7-double piston cylinder, 8- pneumatic distributor, 9-pressure regulator, 10 – compressor, 11 – Pt100 thermo-resistance, 12 – pressure transducer)

**The system for monitoring and controlling the extraction process** is formed by the following components: microPLC AL2 – 14 MR – D with extension for analogical outlets AL2-2DA, interface module RS232 AL2-GSM-CAB and signal adapter Pt100 AL2-PT-ADP, operation terminal GT1050 – QBBD with connection cable GT01-C10R4-8P, power source in commutation 24Vcc type PSU 50, bipolar safety C32, relay bloc Omron, metallic box, safety button, rail, metallic riglet, feeding cable  $\Phi$  1.5 mm – 20 ml, feeding cable 3x1.5 mm – 10 ml. the monitoring and control system receives information from the temperature sensor Pt100, the pressure sensor and graphic user interface represented by the operation terminal and transmits commands to the execution elements of the integrated extraction systems and the heating mantle.

The program installed in the PLC allows the control of the following components: compressor, heating mantle, recirculation pump, electro-valves, pneumatic distributor, pressure regulator. The reference values of working parameters can be set by the operator using the operation terminal.

The equipment has the following circuits in its componence:

1. pneumatic circuit: from the compressor to the pneumatic cylinder
2. hydraulic circuit: from the feeding tank to the extraction tank, to the emptying tank and to the hydraulic cylinder.
3. electric circuit: for powering compressor, PLC, operation terminal, pneumatic distributor, pressure regulator and the heating mantle.

In the microPLC equipped on the monitoring and control system of the EXTBIO experimental model was achieved a control software of the integrated extraction system setting the parameters for the following procedure (parameters), according to figures 2 and 3:

- ✚ extraction time: 5600 seconds;
- ✚ high extraction pressure: 8.7 bar;
- ✚ low extraction pressure: 1.25 bar;
- ✚ numbers of cycles at high pressure: 5 cycles;
- ✚ numbers of cycles as low pressures with quasi-dynamic variation between 0 and 1.25 bar: 5 cycles with 5 quasi-dynamic cycles each;

- ✚ high pressure cycle duration: 600 seconds;
- ✚ low pressure cycle duration: 520 seconds with a duration of a quasi-dynamic cycle of 40 seconds, 80 seconds pause before and after the high-pressure cycle and 40 seconds pause between low pressure quasi-dynamic cycles;
- ✚ extraction temperature: 37 °C;
- ✚ counter flow circulation of solvent throughout the high-pressure cycles;

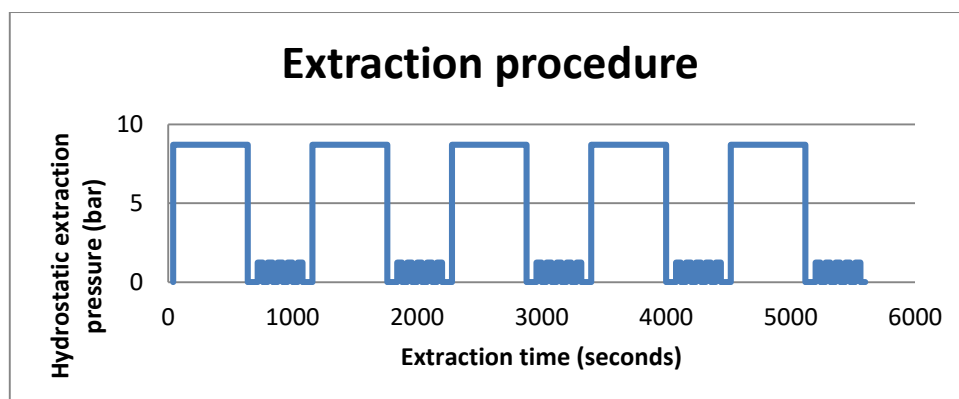

Figure 2. Representation of the extraction procedure

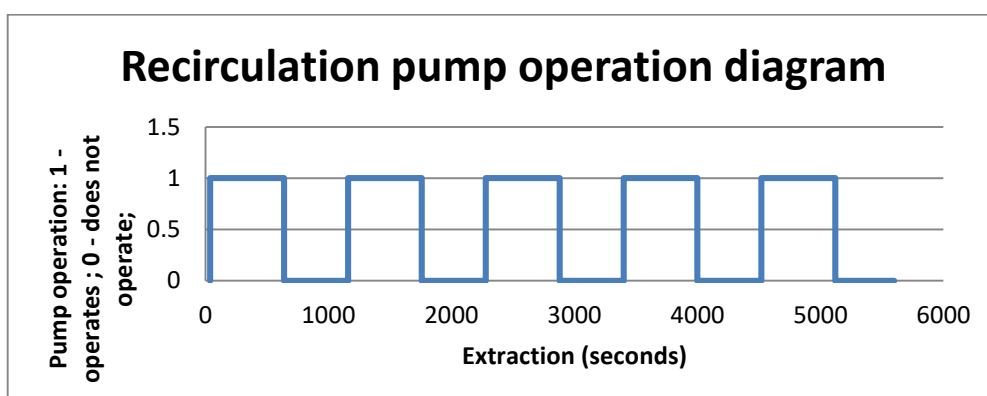

Figure 3. Representation of the operation diagram for the recirculation pump during the extraction procedure

For experiments, the following plants were used as raw material:

- ✚ horseradish (whole plants) for obtaining an extract with bioactive substances with foliar bio-insecticide role.
- ✚ Solvent used for experiments was distilled water obtained within the chemical laboratory of INMA Bucharest.

Following the experiments conducted using EXT BIO equipment, the following results were obtained for the exploitation parameters (table 2):

Table 2. Results

No.	Parameter determined	M.U.	Value
1.	Sample duration	s	5600
2.	Mass of chopped material subjected to extraction	kg	1

3.	State of the raw material subjected to extraction	-	<i>dry</i>
4.	Moisture of the sample subjected to extraction	%	10.75
5.	Degree of extracting active principles	%	34.45

### 3.CONCLUSIONS

According to the rules imposed by the legislation in the field, the use of fertilizers / insecticides without traces of chemical synthesis substances is absolutely mandatory in the practice of ecological / organic farming. Thus, the discovery of new substances and compounds with fertilizer / insecticide action represents a continuous challenge for the field of agricultural research in the 21<sup>st</sup> century. The discovery of these new chemical compounds is possible through the study of various plant extracts obtained from the variety of plants available on the earth's surface. Depending on their biochemical composition, these plant extracts can be used as substances with biofertilizer / bio-insecticide role with use in organic farming. Their quality is influenced by the fact that they are not dangerous for humans, plants, soil and the environment in general. They can be made from handy substances and therefore do not have very exorbitant prices. They can be used when infestation has occurred or can be preventively applied.

The degree of extracting active principles was calculated after the samples were kept inside the oven set at 105°C for 22 hours.

As organic pesticide, it is good to use singular horseradish extract or in combination with hot pepper, against pests and foliar diseases. They are applied against aphids, white muskets, caterpillars, Colorado beetle, etc.

Horseradish can also be as organic fungicide. It prevents blistering attack on tree leaves. It is used against mildew on various crop plants, by spraying repeatedly at several days.

**Acknowledgement:** This work was supported by a project PNCDI III and of Romanian National Authority for Scientific Research and Innovation, CNCS/CCCDI –UEFISCDI, project number **PN-III-P1-1.2-PCCDI-2017- 0566** (ctr. Nr. 9 PCCDI/2018- COMPLEX SYSTEM OF INTEGRAL VALUABILITY OF AGRICULTURAL SPECIES WITH ENERGY AND FOOD POTENTIAL, COMPONENT PROJECT 3 -Valuation of the energy potential of certain species of agricultural plants).

### References

- [1]. Arun KS., *Bio-fertilizers for sustainable agriculture*. Mechanism of P-solubilization, Agribios Publishers, Jodhpur, India, pp.196-197, 2007.
- [2]. Bhardwaj D., Mohammad W. A., Ranjan K., Narendra T., *Biofertilizers function as key player in sustainable agriculture by improving soil fertility, plant tolerance and crop productivity*, Microbial Cell Factories , pp 13-66, 2014.
- [3]. Mishra DJ, Rajvir S., Mishra U.K., Kumar S.S., *Role of bio-fertilizer in organic agriculture: a review*, Research Journal of Recent Sciences, Vol. 2(ISC-2012), pp.39-41, 2013.
- [4]. Romdhane M., Gourdon C., *Investigation in solid–liquid extraction: influence of ultrasound*. JOURNAL CHEMICAL. EngINEER, nr. 87, pp. 11–19, 2002.
- [5]. Samuil C., *Tehnologii de agricultură ecologică*, suport de curs, usamv Iași, pp. 35-58, 2007.
- [6]. Wang L., Weller C.L., *Recent advances in extraction of nutraceuticals from plants*. TRENDS FOOD SCI. TECHNOL. 2006, 17, pp. 300–312, 2006.
- [7]. Pruteanu A., Muscalu A., Voicea I., Ferdes M., *Current stage of experimental research on extraction of biologic active substances from medicinal and aromatic plants / Stadiul actual al cercetarilor experimentale privind extractia substantelor biologic active din plante medicinale si aromatice*, INTERNATIONAL SIMPOSIUM \_ISB-INMA TEH', pp.465-475, 2014.

# FLOTATION PROCESS IN WASTEWATER TREATMENT

PhD. Eng. Voicea Iulian<sup>1)</sup>, PhD. Eng. Moga Corina Ioana<sup>2)</sup>, PhD. Stud. Eng. Găgeanu Iuliana<sup>1)</sup>, PhD. Eng. Matache Mihai<sup>1)</sup>, PhD. Eng. Vlăduț Valentin<sup>1)</sup>,  
PhD. Eng. Covaliu Cristina<sup>3)</sup>, Cristea Mario<sup>4)</sup>

<sup>1)</sup>INMA Bucharest, <sup>2)</sup>DFR SYSTEMS, <sup>3)</sup>University Politehnica of Bucharest,  
<sup>4)</sup>SC Cantarpprod SRL  
E-mail: *voicea\_iulian@yahoo.com*

## ABSTRACT

Flotation is the process of entraining particles suspended in a liquid at its surface by means of gas bubbles adherent to these particles. Flotation as a technological process is applied in two versions depending on particle density. In the case of larger density particles, which settle rapidly, flotation is only possible with fine granulation (maximum diameter of 0.4 mm); for these materials is operated with large bubbles (having average diameters of 2 mm) to which the solid particles adhere. In the case of low-density particles floating on the surface or between layers, or which are very difficult to deposit, flotation can be carried out under more favourable conditions; the ascending force required to raise a particle to the surface is smaller, one or more fine bubbles are sufficient. The purpose of this procedure is to separate from the wastewater oils, grease or other substances lighter than water, which rise to the surface in tranquil areas and with a low horizontal speed.

## 1. INTRODUCTION

Flotation can be described as the process of separating solid suspensions by forming a particle-bubble conglomerate of a specific weight smaller than the specific weight of the water and which is raised to the surface of the water from where it is removed. Depending on the manner they are carried out, flotation processes are divided in:

- ✓ **Natural flotation** where the difference of specific weight is sufficient for removing suspensions;
- ✓ **Assisted flotation** where certain compounds that improve particle separation are added;
- ✓ **Provoked flotation** where the specific weight of particles is bigger than the specific weight of water and is necessary to introduce air for eliminating them.

Water oxygenation processes are encountered in wastewater treatment and epuration plants, in the food, fish and chemical industries. Oxygen dissolved in water is known as dissolved oxygen (fig. 1) and is conventionally measured in milligrams of oxygen / litre.

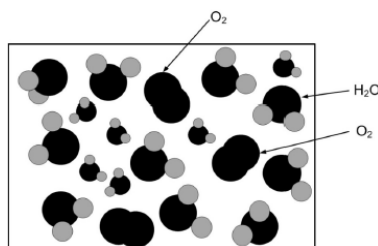

Figure1. Molecular structure of water dissolved oxygen

<sup>1</sup> Bucharest street Petre D.Ionescu, nr.51., tel: 0752161780, e-mail: *voicea\_iulian@yahoo.com*



Figure 1 shows that each molecule of water consists of an oxygen molecule to which two hydrogen molecules are bound (a black sphere coupled with two white spheres), and between the molecules of water there are oxygen molecules (black spheres) constituting the dissolved oxygen. The maximum quantity of air that can be dissolved (absorbed in water) depends on multiple physical-chemical factors:

- ✓ the pressure exerted on water;
- ✓ water temperature;
- ✓ water salinity (quantity of salt existing in the water);
- ✓ water clarity.

Factors leading to a decrease in the air dissolved in water are ii care:

- ✓ increased water temperature;
- ✓ low pressure on the water;
- ✓ water pollution with petrol, oil, detergents;
- ✓ presence of ice;
- ✓ water depth;

The quantity of oxygen absorbed in water varies depending on:

- ✓ atmospheric pressure;
- ✓ water temperature;
- ✓ different quantity in mineral salts;
- ✓ organic substances.

### **Physical and chemical treatment of urban effluents from variable population resorts**

It is known that the use of ordinary biological treatments on effluents does not allow satisfactory treatment in case of rapid population growth. Water treatment through flotation has the advantage of a reduced size of installations that require a substantially lower land area. This is all the more important as the cost of land in urban and tourist areas is higher. The physical-chemical treatment applied by flotation applied to household effluent reduces 95% of suspended matter, eliminates 95% phosphates, 80% detergents and has a deodorizing effect, [1,2,3,4]. Flotation also ensures the possibility of treating drinking water in tandem with the use of highly fine sand filters. The amount of generally lightweight materials suspended in surface water can be highly reduced, also allowing the removal of micropollutants such as detergents. The choice of sedimentation or flotation as a method of separating impurities from wastewater is based on technical and economic criteria. In the case of floatation, operating costs are higher than in the case of sedimentation due to the energy required to produce air bubbles. On the other hand, the investment costs are lower, the separation productivity is higher and the machines' size is lower, [5]. The volume of sludge produced by flotation is also 3-4 times lower than in the case of sedimentation, as the resulting sludge moisture can be reduced more quickly and easily. Flotation separation is effective for wastewater from the food industry, the pulp and paper industry, etc., but has not proven to be effective in treating sewage waters. This is why the costs are also increased due to the need for flocculation treatments prior to flotation. Separation by decantation has as drawbacks: increased moisture of the obtained sludge (98-99 %) and the occurrence of unpleasant odour due to putrefaction phenomena occurring in the wastewater, [6].

## **2. METHODOLOGY**

Removing fats from wastewater is a vital measure for biological treatment in aeration tanks. The presence of fats in the aeration tanks prevents (stops) the transfer of oxygen from air to water due to changes occurring at the interface between the two fluids. In addition, the recycling

of fats and oils extracted from flotation wastewater can be a profitable operation, taking into account the large quantities of oil discharged into the sewage.

In the case of flotation processes applied for the separation (concentration) of ores, it is necessary to add foaming agents in order to reduce the superficial tension and to facilitate the formation of a stable foam. Foaming agents are surfactants, polar or non-polar, which reduce surface tension due to the accumulation trend at the liquid-gas interface. Added substances are adsorbed to the surface of air bubbles by covering them with a very thin film that makes the bubbles flexible and stable, [7,8].

The basic conditions for separating solid impurities by flotation are: the adhesion of impurities particles to the air bubble and the displacement of the bubble - particle assembly at the surface of the liquid. The phenomenon of adhesion of particles to the surface of the bubbles is based on the degree of wetting of the solid particles.

Solid surfaces are only wetted by some liquids. Wetting depends both on the nature of the solid particle and on the nature of the liquid phase. The degree of wetting is measured by the angle of contact between the tangent to the solid-liquid, liquid-gas plane and solid-gas interface, measured to include the liquid phase.

The value of the wetting angle (junction or edge) is determined by the equilibrium of the three superficial tensions of the three interfaces encountered in the wetting perimeter:  $\sigma_{LS}$  (liquid-solid);  $\sigma_{SG}$  (solid-gas);  $\sigma_{LG}$  (liquid-gas). The first tends to decrease the liquid-solid contact surface, the second to increase it in order to reduce the solid-gas interface, and the third tends to decrease the fluid interface with the gas. For determining the conditions for the flotation process, examine the gas bubbles fixed on the solid particles in the liquid. At the solid / liquid interface (in the case of impurities in water) the molecular interactions are manifested, [7,9].

The forces of attraction between the liquid molecules and the solid impurity (or liquid – for example oil) are called adhesion forces. If the adhesion forces are greater than the cohesion forces between the molecules of the fluid subjected to clarification, then the liquid humidifies (wets) the solid surface. The particles are lyophile (hydrophilic in the case of water), [10,11].

In exchange, if the forces of cohesion are stronger, the particles are lyophobic (hydrophobic in the case of water), meaning that they are not wetted by the liquid. The measure of these behaviours is given by the wetting angle (contact or edge).

The wetting angle can be calculated from the equilibrium condition at the interface, given by the Young-Laplace relation (fig. 2).

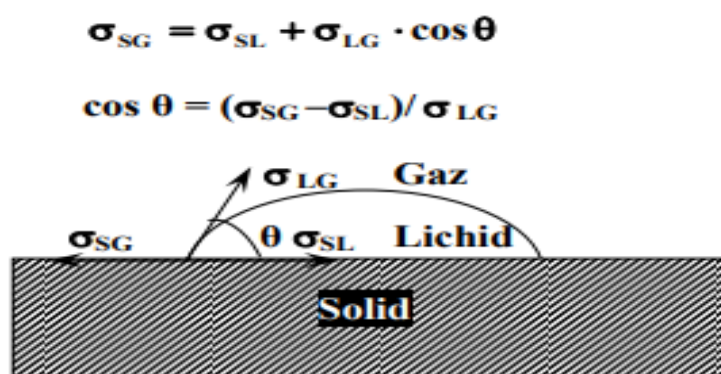

Figure 2: Action of superficial tensions at the solid – liquid – gas interface

The solid particle has a higher degree of wetting - it is lyophile (hydrophilic in water) - the smaller the angle  $\theta$  ( $0 < \theta < 90^\circ$ ) and becomes lyophobic (hydrophobic in the case of water) if the angle  $\theta$  is higher ( $90 < \theta$ ).

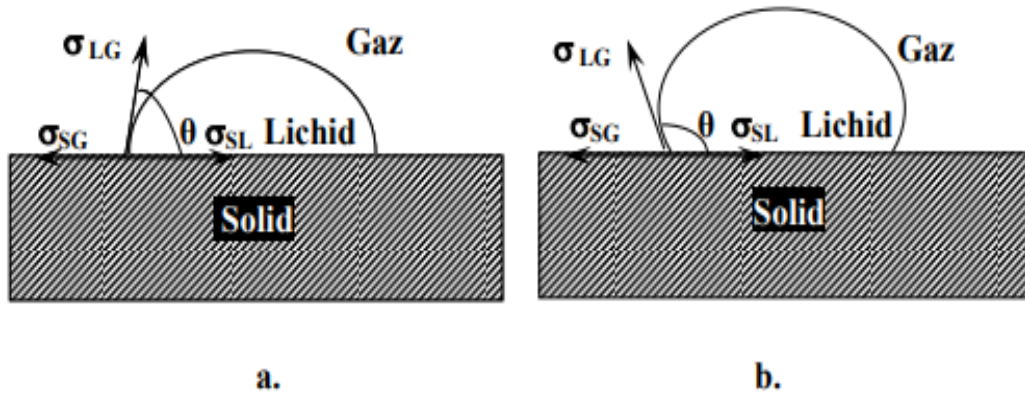

Figure 3: Wetting manner at solid-liquid interface: a. hydrophilic surface  $0 < \theta < 90^\circ$ ; b. hydrophobic surface  $\theta > 90^\circ$

It can be seen from the Young - Laplace relation that the contact angle  $\theta$  depends only on the interface conditions (liquid-gas, solid-liquid and solid-gas), being independent of the diameter of the gas bubble (air). The magnitude of the contact angle increases with the increase in the surface tension at the liquid (water) - bubble (air),  $\sigma_{LG}$  interface and / or the increase from the solid (particle) - gaseous (air) interface which implies a high hydrophobia for the surface of the solid particle.

The second flotation condition, by which the solid particle and the air bubbles rise and float to the surface, is given by the relation between the forces acting on the bubble-particle aggregate. On the bubble-particle aggregate acts an ascending force  $F_A$  (ascension), which causes the aggregate to rise to the surface, and the gravitational force  $G$ .

For the flotation to occur, the following condition needs to be complied with [7]:

$$F_A \geq G$$

$$F_A = g(\rho_L - \rho_G) \times V_G \geq g(\rho_S - \rho_L) \times V_S \quad (1)$$

where:

$\rho_L$  – liquid density (example water);  $\rho_S$  – solid particle density;  $\rho_G$  – density of the gas in the bubble (example air);  $V_G$  – volume of the gas bubble;

If we replace  $V_S = m_s / \rho_s$  in relation (1), it results:

$$V_G = \frac{m_s}{\rho_s} \times \frac{\rho_s - \rho_L}{\rho_L - \rho_G}$$

$$V_G = \frac{\pi d^3}{6} \quad (2)$$

$$d = \sqrt[3]{\frac{6}{\pi} \times \frac{m_s}{\rho_s} \frac{\rho_s - \rho_L}{\rho_L - \rho_G}}$$

In three-phase systems, the specific energy of adhesion of solid particles to the air bubble is given by the relation:

$$\lambda = \sigma_{LG} + \sigma_{SL} - \sigma_{SG} = \sigma_{LG}(1 - \cos \theta) = 2\sigma_{LG} \sin^2 \theta / 2 \quad (3)$$

Therefore, the flotation capacity of a solid material is determined by the adhesion energy and increases in proportion to the angle of contact and hydrophobicity. A larger contact angle

$\theta$  is characteristic for materials that cannot be wetted and can only be achieved by very fine bubble contact, which requires more energy. The conditions required for the bubble-particle aggregate to rise or float is that the ascent force of the bubble is superior to the weight of the granule and the viscous resistance force. Flotation therefore employs the ability of the immiscible solid or liquid particles to attach to the gaseous bubbles with the formation of aggregates with a lower net density in ratio to the density of the liquid.

For larger density particles - such as metal deposits, which sediment rapidly, flotation can only be applied to particles with a diameter of less than 0.2 mm. In this case, flotation agents are used to produce large carrier bubbles (about 2 mm).

Due to the high cost of foaming agents, the process only applies for the separation of valuable metal ores. For low-density particles that float or deposit very slowly (fibrous, fat or flocculated particles), flotation takes place under more favourable conditions. In this case, the gravitational force is smaller and therefore smaller bubbles are required. If these bubbles have a lower contact angle, their adhesion force is higher and therefore flotation can be achieved under conditions of maximum efficiency. The flocculated particles can be well separated by flotation because they can be easily captured by the air bubbles. Colloidal substances can be removed by artificial flotation only after a pre-flocculation. Artificial flotation can also remove fat emulsions because they adhere to the gas-liquid interface, [10,11, 12,14].

An important problem for flotation is the stability of the foam layer. If it has low stability, immediate removal is required, while a too great stability implies the need for additional treatments.

### 3. CONCLUSIONS

Flotation separation has the following advantages:

- ✚ is not sensitive to toxic agents;
- ✚ is efficient for separating specific pollutants: fats, hydrocarbons, detergents;
- ✚ ensures the deodorisation of waters treated;
- ✚ allows excellent concentration of the separated sludge;
- ✚ is applied in easy exploitation conditions;
- ✚ offers the possibility of being applied in various fields: treating industrial effluents, urban waters, treating drinking water;
- ✚ the sludge obtained is much drier and concentrated in solid matters than in the case of static decantation.
- ✚ the consumption of electric energy is relatively low, but slightly higher than in the case of separation by decantation. If the concentration of solid matter floated is smaller than 2 g/l, electric energy consumption is situated between 100-200 Wh/m<sup>3</sup>. For superior concentrations, consumptions rise up to 50-100 Wh/kg of solid matter extracted. For electro-flotation, consumption depends on the liquid's resistivity, therefore on salinity, which, for the same intensity, requires a tension as higher as resistivity is higher.

In air flotation, temperature influences the maximum air solubility, but at the same time, the dissolution kinetics increases with the temperature. Flotation allows, along with the elimination of insoluble compounds, including pre-flocculated colloidal particles, the partial elimination of dissolved pollutants. It is known that certain dissolved compounds are concentrated on the gas-liquid interface and that this phenomenon is related to superficial tension. This phenomenon used for foaming concentration allows physicochemical treatment by flotation with remarkable elimination yields. In order to increase flotation efficiency or to separate impurities that would not normally be eliminated by flotation, flotation reagents are added in the liquid medium: frothers, collectors or depressants.

## Acknowledgement

This work was supported by a grant of the Romanian National Authority for Scientific Research and Innovation, CNCS/CCCDI –UEFISCDI, project number PN-III-P2-2.1-PTE-2016-0183 (25/2016 – Improved flotation treatment technology for heavily loaded wastewaters) within PNCDI III and project ctr. nr..7PS. / 09.11.2017 -PLAN SECTORIAL MCI (INCDPM Buc.)- Valorization technologies for resulted sludge from wastewater treatment city stations and waste from landfill sites.

## References

- [1]. Li Y., Mei H., Fang H., *A review of treating oily wastewater*, Arabian Journal of Chemistry, Volume 10, Supplement 2, pp. 1913-1922, 2017.
- [2]. Amaral J., Filho A., Azevedo R., Etchepare J., *Removal of sulfate ions by dissolved air flotation (DAF) following precipitation and flocculation*, International Journal of Mineral Processing, Vol. 149, pp 1-8, 2016.
- [3]. Shahryar J., *6: Treatment of Oily Wastewater*, Book chapter Petroleum Waste Treatment and Pollution Control, pp. 185-267, 2017.
- [4]. Bendicho C., Lavilla I., *Sewage*. Reference Module in Chemistry, Molecular Sciences and Chemical Engineering, 2014.
- [5]. Qidian Z., Shujie L., Chunping Y., Fuming C., Songlin L., *Bioreactor consisting of pressurized aeration and dissolved air flotation for domestic wastewater treatment*. Separation and Purification Technology, Vol. 138, pp. 186-190, 2014.
- [6]. Jincal R., Jiongtian L., Chunjuan Z., Dengyue W., Xiaobing L. *Experimental investigation and modeling of flotation column for treatment of oily wastewater*, International Journal of Mining Science and Technology, Vol. 23, Issue 5, Pages 665-668, 2013.
- [7]. Racoviteanu G., *Teoria decantarii si filtrarii apei*, Editura MATRIX ROM, ISBN 973-685-541-4, pp.55-63, 2003.
- [8]. Ritesh P., Subrata K. M., Anugrah S., *Flotation technique: Its mechanisms and design parameters*, Chemical Engineering and Processing - Process Intensification, Vol. 127., Pages 249-270, 2018.
- [9]. Scholz M., Chapter 9 – *Flotation Systems*, Wetlands for Water Pollution Control (Second Edition), pp 55–59, 2016.
- [10]. Michał G., Andrzej P., Grzegorz B., *Wastewater treatment by means of advanced oxidation processes based on cavitation – A review*, Chemical Engineering Journal, Volume 338, pp.599-627, 2018.
- [11]. Mohammad H. D., Behrooz K., Mohammad S. R., *The effect of aeration on advanced coagulation, flotation and advanced oxidation processes for color removal from wastewater*, Journal of Molecular Liquids, Vol. 223, pp. 75-80, 2016.
- [12]. Universitatea Tehnică din Cluj-Napoca, *Procedee fizico-mecanice de separare a poluanților*, Note de Curs.
- [13]. Universitatea Politehnică București, Facultatea Energetică, *Flotația*, Referat. (<https://www.scribd.com/document/77807669/FLOTATIA>).
- [14]. Wojciech D., Radosław Ż., Paweł M., *Evaluation of energy consumption during aerobic sewage sludge treatment in dairy wastewater treatment plant*, Environmental Research Vol. 153, pp. 135-139, 2017.

# **“PLANT STRESS” – THE FIRST INDICATION THAT A LANDFILL GAS (LFG) MIGRATION IS TAKING PLACE NEAR THE MSW LANDFILL**

Gheorghe Voicu<sup>1</sup>, Dănilă Vieru<sup>1</sup>, Laura Toma<sup>1</sup>, Paula Tudor<sup>1</sup>

<sup>1</sup> University “Politehnica” of Bucharest

## **ABSTRACT**

Climate change and greenhouse effect are issues that cause unexpected phenomena such as: temperature increase above the annual average in temperate continental and arctic areas, desertification in areas with predictable rainfall, the occurrence of tornadoes and tropical storms in temperate continental climate.

It is widely accepted that the “plant stress” phenomenon also originates in the unfriendly management of all types of waste generated by industrial, agricultural and domestic activities, as well as by deforestation beyond the regeneration possibilities of the forest. The increase in the concentration of greenhouse gases in the atmosphere leads to the increase of the ambient temperature, to the increase of the evapotranspiration phenomenon, practically to the death of spontaneous and planted vegetation. Studies published by renowned researchers attest to the fact that non-maintenance of LFG generated by MSW landfill, whether compliant or not, lack of collection and treatment facilities or inefficient operation of existing facilities are responsible for the global warming phenomenon with a percentage ranging from 3 – 5%. At the same time, the migration of LFG in the landfill vicinities produces vegetal stress phenomena but can also generate explosions or fires in case they accumulate in non-aerated closed spaces.

The paper presents a LFG collection system with vertical extraction wells, the calculation of the pressure drop (vacuum) required for transporting the LFG stream through the pipe system at the source, and, after it has been cleaned, at the consumers (flame burner, motor with internal combustion, domestic users or hot water boiler). In addition, the collection and management condensation system is presented in the paper as part of a good functioning of the LFG collecting system.

## **1. INTRODUCTION**

Municipal solid waste (MSW) landfills complying with environmental legislation are and will be used as a disposal method in the future [1]. Finding locations for landfill is a concern of all local, regional and central environmental authorities. MSW storage will accompany all actions related to environmentally friendly management such as recycling, recovery, reuse, use as a fuel for thermal power plants, cement industry operators, or simply lowering the volume by incineration in plants with environmental integrated licence.

The fact that MSW landfills generate LFG's containing greenhouse gases leads to the retention of LFG at source and the use of components with energy content for economic purposes. LFG contains CH<sub>4</sub>, CO<sub>2</sub>, VOC, NMOC and other gases. Major interest is given to methane, a strong greenhouse gas (21 times more powerful than CO<sub>2</sub>). The methane content of LFG has economic interest even though it has a lower energy value than methane from natural gas [2]. However, LFG containing CH<sub>4</sub> also has important disadvantages, such as: it can escape from the body of the landfill, it can accumulate in uncovered spaces generating explosions, may cause fires, can cause the vegetation stress [2]. The impact of a landfill refers to environmental

factors, health and toxicity issues, vegetation stress, greenhouse gases, odorous gases, and potential hazards such as explosions and fires.

Through the contained gases, other than CH<sub>4</sub> and CO<sub>2</sub>, such as H<sub>2</sub>S, NMOC, mercaptans, LFG is extremely dangerous for human health. Moreover, in the case of H<sub>2</sub>S, olfactory sensitive mercaptans, there is a danger of fire, and in high concentrations can cause the death of maintenance personnel. Figure 1 schematically presents the impact on air, vegetation, water bodies (groundwater) of the migration of LFG containing CH<sub>4</sub>, CO<sub>2</sub> and other gases, as well as the migration of the leachate into a body of underground water [3].

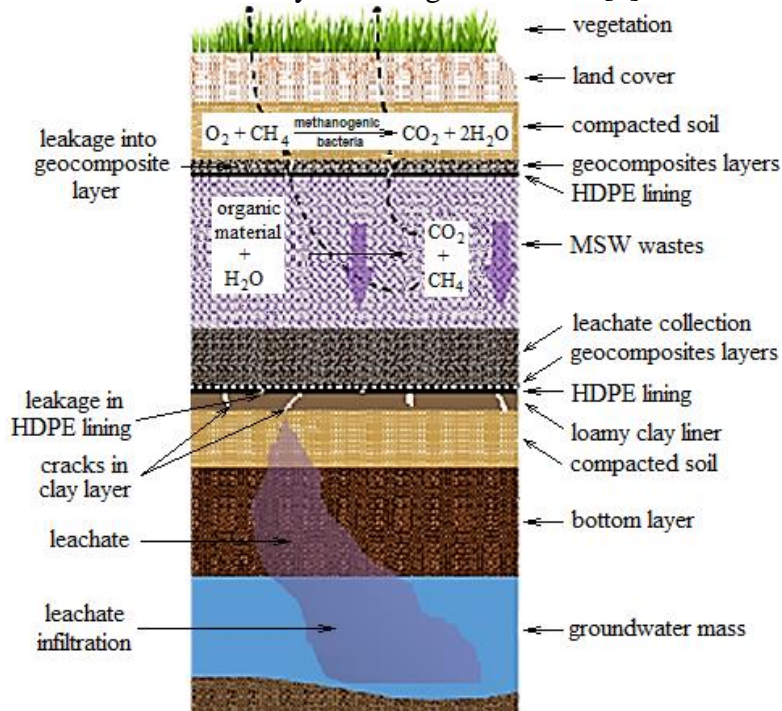

Figure 1: The potential impact of a landfill on groundwater and vegetation

It is observed that in vegetation support layer, under the action of methanogenic bacteria, the CH<sub>4</sub> stream is decomposed into CO<sub>2</sub> and H<sub>2</sub>O by O<sub>2</sub> consumption. That can be explained the plant stress due to LFG migration.

It is to be noticed that besides the influence of CH<sub>4</sub>, which consumes O<sub>2</sub> from the aerated soil, CO<sub>2</sub> also increases the naturally occurring CO<sub>2</sub> gradient leading to the displacement of O<sub>2</sub>, H<sub>2</sub>O and CO<sub>2</sub> from air around the plant roots [3-5]. As a solution to diminishing the LFG-generated greenhouse effect through CH<sub>4</sub>, N<sub>2</sub>O and other chemical compounds, it is proposed to build composting stations in the landfill. It is important to note that the appearance of vegetation stress [3, 6] (yellowing of the leaves, appearance of black spots on the surface of the leaves, root inhibition, reduction of the canopy, reduction in the size of the leaves etc.) is an indication that the cover of the landfill begins to crack and massive leakage of LFG appears. Because of the subject's complexity, the issue of managing LFGs in safe environmental and health conditions far exceeds the space allocated to this article. In addition to LFG's containing greenhouse gases, other pollutants such as SO<sub>2</sub>, suspended particulate matter, NO<sub>x</sub> generate different types of pollution in atmosphere.

## 2. ADVANCED RESEARCH ON THE LANDFILL IMPACT ON ENVIRONMENTAL FACTORS

This paper summarizes the results of some researchers on the landfill impact through LFG and leachate on vegetation and water bodies. The objective of these researches was:

- to analyse the effect of greenhouse gases contained by LFG on vegetation (see Table 1);
- to determine which plant species are likely to be planted in closed and rehabilitated MSW landfills;
- to determine the maximum explosion and fire limits for the presence of LFG components (CH<sub>4</sub>, H<sub>2</sub>S, mercaptans, VOC's, NMOC's) in the atmosphere around inhabited areas;
- to determine the O<sub>2</sub> concentration limits in the MSW landfill body that generate underground fires;
- to analyse the leachate effect on planted and spontaneous vegetation as well as on water bodies.

### ***Potential impact of LFG on human agglomerations and vegetation***

Among the identified negative effects of LFG can be listed:

- unpleasant odourless smell due to the presence of H<sub>2</sub>S, mercaptans, aldehydes in small concentrations (see Table 1) generates discomfort even if concentrations remain well below the health thresholds;
- greenhouse gases content: CH<sub>4</sub>, CO<sub>2</sub>, N<sub>2</sub>O, H<sub>2</sub>O and NMOC. Table 1 shows the gases concentration from LFG and their global warming potential (GWP) of the atmosphere. GWP is an indicator to consider;
- LFG migration may cause air movement thus creating an oxygen deficient atmosphere. This oxygen deficiency may be severe enough to present a choking hazard to people in the area;
- LFG can form an explosive mixture [2, 8, 9] when combined with air in certain proportions (see Table 2). Risk of explosion occurs in the presence of a source of ignition;
- Vegetation stress is a sign of LFG migration through the substrate or end cap of the MSW landfill and occurs because plant roots are deprived of oxygen or LFG contains components that are toxic to plants. Deterioration of vegetation on and near MSW landfills can be both an aesthetic and a practical problem.

Of course, among the many possibilities to identify and eliminate the negative effects of a landfill, vegetation stress is considered a relevant indicator of action. Stress vegetation indicates subtle changes in the area of a landfill [6, 7].

Plant stress is manifested by altering the chlorophyll concentration that can lead to reduced photosynthesis. Among the methods for identifying plant stress is the measurement of fluorescence of chlorophyll by spectrophotometry [6, 7] and remote sensing. Both are non-destructive methods of research on plant stress.

Table 1: LFG compound concentrations and their GWP

LFG compound	Chemical formula	Concentration limits	GWP
Methane	CH <sub>4</sub>	0 – 65 Vol.%	21
Carbon dioxide	CO <sub>2</sub>	0 – 55 Vol.%	1
Nitrous oxide	N <sub>2</sub> O	up to 428 mg/m <sup>3</sup>	310
Carbon monoxide	CO	0 – 2.8 Vol.%	–
Ammoniac (by ammonium ion NH <sub>4</sub> <sup>+</sup> )	NH <sub>3</sub>	0 – 0.35 ppm	–
Hydrogen sulfide	H <sub>2</sub> S	0 – 700 ppm	–
Ethylmercaptan	C <sub>2</sub> H <sub>5</sub> SH	0 – 120 ppm	–
Benzene	C <sub>6</sub> H <sub>6</sub>	up to 800 ppm	–
Dichlorodifluoromethane	CCl <sub>2</sub> F <sub>2</sub> (F11)	up to 700 mg/m <sup>3</sup>	4000
Trichlorofluoromethane	CCl <sub>3</sub> F (F12)	up to 480 mg/m <sup>3</sup>	2400
Triclorotrifluoromethane	C <sub>2</sub> Cl <sub>3</sub> F <sub>3</sub> (F113)	up to 52 mg/m <sup>3</sup>	4800
Dichloromethane	CH <sub>2</sub> Cl <sub>2</sub>	up to 2400 mg/m <sup>3</sup>	–
Acetaldehyde	CH <sub>3</sub> CHO	up to 150 ppm	–
Other gases		7 – 200 mg/m <sup>3</sup>	–



Table 2: Concentrations and characteristics of LFG components

Types of gases in LFG	Volume percent	Characteristics
CH <sub>4</sub>	35 – 60	Methane (CH <sub>4</sub> ) is a natural gas. It is colourless and odourless. Extremely explosive when mixed with air at a volume of LEL <sup>1</sup> of 5% and of UEL <sup>2</sup> of 15%. At concentrations below 5% and above 15%, methane is not explosive.
CO <sub>2</sub>	40 – 50	Naturally, it is found at low concentrations in the atmosphere (0.033%). It is colourless, odourless and slightly acidic. It is not flammable or explosive.
N <sub>2</sub>	2 – 5	Nitrogen comprises about 78% of the atmosphere. It is odourless, tasteless and colourless. It is not flammable or explosive.
O <sub>2</sub>	0.1 – 1	Oxygen comprises about 21% of the atmosphere. It is odourless, tasteless and colourless. It is not flammable or explosive.
Ammonium NH <sub>4</sub> <sup>+1</sup>	0.1 – 1	Ammonia is colourless gas with a viscous and flammable odour. LEL is 15% and UEL is 28%. However, ammonia is unlikely to be collected in a concentration high enough to present an explosion hazard.
NMOC	0.01 – 0,6	NMOCs may occur naturally or may be formed by chemical reactions. The most common NMOCs include acrylonitrile, benzene, 1,1-dichloroethane, 1,2-cis dichloroethylene, dichloro-methane, carbonyl sulphide, ethylbenzene, hexane, methyl ethyl ketone, tetrachloroethylene, toluene, trichloroethylene, vinyl chloride and xylene. Potential explosive hazards will vary depending on the chemical. For example, benzene LEL1 is 1.2% and UEL2 is 7.8%. However, benzene and other NMOC substances are unlikely to be collected at concentrations sufficiently high to represent explosion hazards.
Compounds with S (example: H <sub>2</sub> S, (CH <sub>3</sub> ) <sub>2</sub> S, mercaptans)	0 – 1	The compounds with S are natural gases that make LFG smell like rotten egg. They can cause unpleasant odours even at very low concentrations. Hydrogen sulphide is flammable. LEL is 4% and UEL is 44%. However, in most landfills it is unlikely to collect H <sub>2</sub> S in a concentration high enough to be a danger of explosion.

<sup>1</sup> LEL – Lower explosion limit; <sup>2</sup> UEL – Upper explosion limit

**What is remote sensing?** Remote sensing technologies can be used to evaluate vegetation and plant health and stress monitoring due to pollutants contained in LFG and leachate.

Also, this aspect is strictly related to soil acidity, pH affecting the metals mobility in the soil. Multispectral and hyperspectral sensors are instruments that record the electromagnetic energy emitted or reflected by different study objects at multiple wavelength ranges called spectral bands or spectral domains (ultraviolet, visible, near and far infrared, thermal infrared). Multi- and hyperspectral sensors are also incorporated into field or laboratory spectrophotometers. The data obtained with these multi- and hyperspectral sensors are called spectral responses that are unique information about those objects or phenomena studied, since each object has its own spectral response. Leaves represent the main surface of the tree crown where energy exchange processes take place, and their optical properties are essential in understanding photon transport within a leaf [10].

Remote sensing [3] is the practice of obtaining remote data on the object of interest. In Figure 3 is represented a way to obtain data from a landfill area related to soil, water, vegetation. Existing pollutants in soil, water, or tree leaves will transmit information that will be transformed into images by processing after collection.

Each pollutant has a specific response and forms absorption bands at certain wavelengths. In Figure 2 can be seen that soil, through the pollutant content, transmits signals at certain wavelengths; the water bodies and vegetation do the same [3].

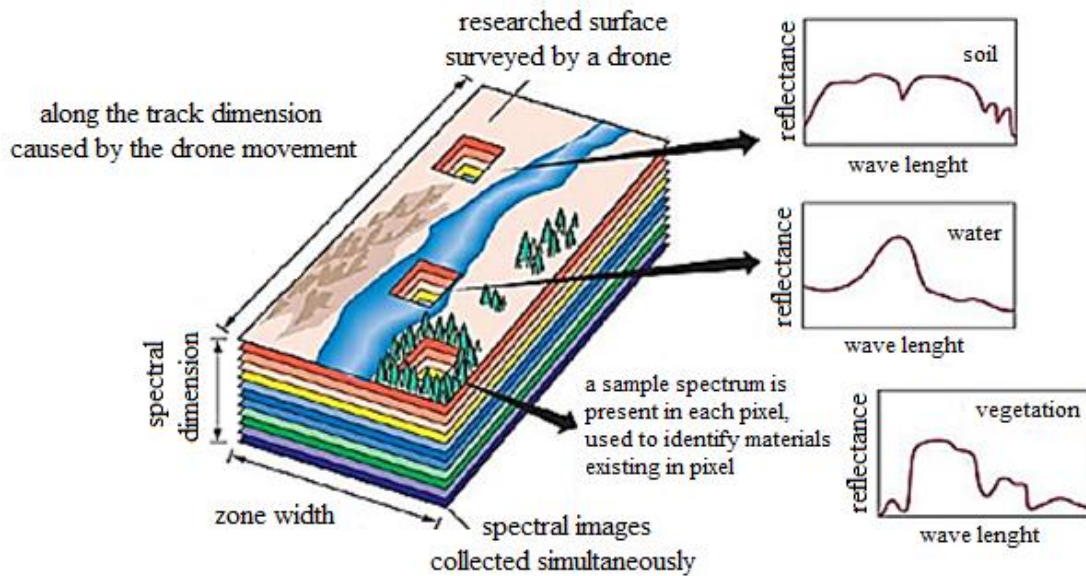

Figure 2: Applying remote sensing to the landfill location

Reflection signals [3, 6] are processed in the visible (red limit), near infrared and infrared domains, as seen in Figure 3.

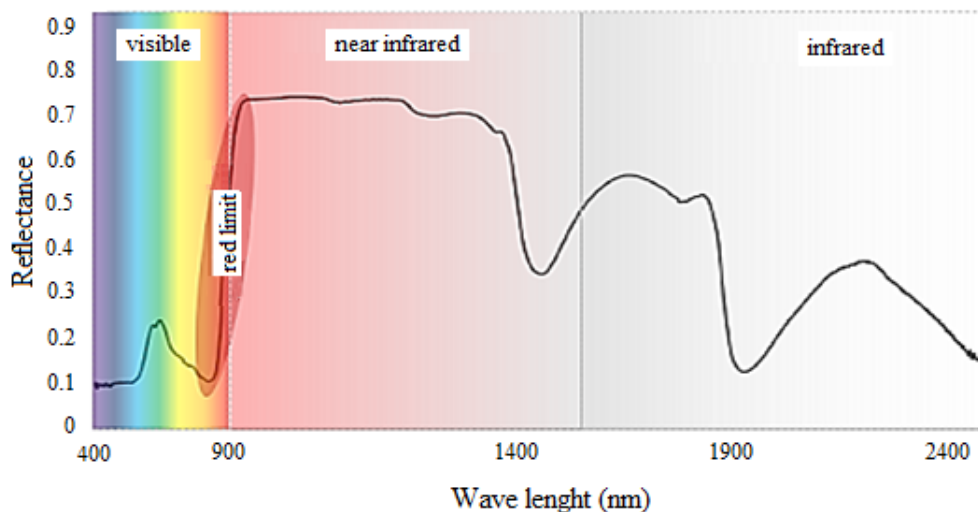

Figure 3: Areas of the electromagnetic field where the information collected by remote sensing is processed

### 3. IMPLEMENTATION OF THE COLLECTION–TRANSPORT–TREATMENT SYSTEM OF THE LANDFILL GAS

Retaining CH<sub>4</sub> at source means collecting a greenhouse gas with high economic value. Installing a retention system means calculations to obtain a pressure drop (vacuum) to extract CH<sub>4</sub> from the waste mass and transport it through a pipe system to combustion systems or economical use.

For the extraction of LFG from the waste mass, the Darcy – Weisbach equation is used [5]:

$$h_f = f \cdot \frac{L}{d} \cdot \frac{v^2}{2g} \quad (1)$$

where:  $h_f$  – loss of pressure through friction, mmHg (1 mm H<sub>2</sub>O = 9,806 Pa; 1 Pa = 0,0075 mmHg);  $f$  – friction factor, dimensionless;  $L$  – pipe length, m;  $d$  – inner pipe diameter, m;  $v$  – average flow velocity, m/s;  $g$  – gravitational acceleration, m/s<sup>2</sup> ( $g = 9,807$  m/s<sup>2</sup>).

The following relationship is used to determine the pressure drop during the LFG transport through the collection pipes:

$$\Delta P = f \cdot \frac{\rho_g}{\rho_w} \cdot \frac{L}{d} \cdot \frac{v^2}{2g} \quad (2)$$

where:  $\Delta P$  – pressure drop, mmHg or Pa;  $\rho_g$  – LFG density, kg/m<sup>3</sup>;  $\rho_w$  – density of manometric liquid, kg/m<sup>3</sup>.

#### 4. REMOVAL OF THE WATER VAPOUR FROM THE LFG

Separation of water vapours contained by LFG is mandatory [5]. The project establishes the amount of water vapours collected in order to size the storage tanks.

The psychometric diagram is used to estimate the amount of water vapour. Water vapour concentration varies for different temperatures, as follows:

- at 32°C (305 K), LFG contains 0.030 kg water vapours/kg;
- at 21°C (294 K), LFG contains 0.015 kg water vapours/kg.

For this reason, the condensate pump is sized for various flows.

#### 5. CONCLUSIONS

LFG collection systems allow for the reduction of the greenhouse effect generated by LFG through CH<sub>4</sub>. A well-designed and operated collection system in accordance with the manufacturer's instructions (of pipelines, valves, fittings, blowers, condensate pumps, flame burners) installed on a landfill, in compliance with the legal provisions in force, ensures a LFG collection efficiency of about 75%.

After treatment, CH<sub>4</sub> obtained from LFG has the same qualities as natural CH<sub>4</sub>. Given the high installation costs, the state needs to be fully or at least 70% involved.

It should be made aware that not only the greenhouse effect generated by landfills matters but also the management of odorous gases, VOCs and non-methane gases. By finding environmentally and rationally ways to manage CO<sub>2</sub>, products of economic interest can be obtained even if CO<sub>2</sub> is a natural constituent of the surrounding atmosphere.

Making graphs on the evolution of the greenhouse effect at each landfill will lead to informing potential investors, but also to the state's interest in recovering the substantial amounts of CH<sub>4</sub> (green energy resource) generated by landfills.

#### References

- [1]. Voicu, Gh., *Ingineria depozitarii ecologice a deseurilor*, Editura Politehnica Press, Bucuresti, 2016.
- [2]. \* \* \*, *Landfill Gas Management Facilities Design Guidelines*, British Columbia Ministry of Environment, Prepared pursuant to Section 7 of the Landfill Gas Management Regulation, March 2010.
- [3]. Sukharia, R., *Vegetation based assessment and monitoring tools for landfill leachate treatment and fugitive plumes*, Masters Theses, 2017, [http://scholarsmine.mst.edu/masters\\_theses/7662](http://scholarsmine.mst.edu/masters_theses/7662).
- [4]. \* \* \*, *Operating Manual for Landfill Gas Collection and Control System for the Sudbury Road Landfill - City of Walla Walla*, Washington, Prepared by CB&I Environment and Infrastructure, April 2017.
- [5]. \* \* \*, *Landfill gas collection and treatment systems*, U.S Army Corps of Engineers, EM 200-1-22, 2013.
- [6]. Lazar A.L., *Contaminarea cu metale grele a solurilor în zona Rosia Montana si stresul indus asupra vegetatiei*, PhD Thesis, Cluj-Napoca, 2013.
- [7]. Lazar, A.L., Baciuc, C., Pop, I.C., *Aplicatiile spectrometrului portabil ASD-Terraspec VNIR-SWIR in monitorizarea stresului vegetatiei*, Ecoterra, no. 28, 2011
- [8]. Guidelines “Capacity strengthening of the SWMCG by introducing applicable methods for assessing landfill gas potential at the existing dumpsites in Georgia”, [www.inogate.org/activities/391?lang=en](http://www.inogate.org/activities/391?lang=en).
- [9]. \* \* \*, Vorgehensweise bei der Planung und Bau einer Zwangsentgasung auf Deponien für Siedlungsabfall und sonstigen gasproduzierenden Abfalldponien, <http://www.dmskroeger.de/engdefault.htm>.
- [10]. Jacquemoud, S., Ustin, S.L., *Leaf optical properties: a state of the art*, Proc. 8<sup>th</sup> International Symposium Physical Measurements & Signatures in Remote Sensing, Aussois (France), CNES, 2001, pp. 223-232.

# EQUIPMENTS USED IN BIOMASS PELLETIZATION PROCESS – A REVIEW

Gheorghe Voicu<sup>1</sup>, Mirela Dincă<sup>1</sup>, Bianca – Ștefania Zăbavă<sup>1</sup>, Nicoleta Ungureanu<sup>1</sup>,  
Iulia Găgeanu<sup>2</sup>, Paula Tudor<sup>1</sup>

<sup>1</sup> Politehnica University of Bucharest, Romania

<sup>2</sup> INMA Bucharest, Romania

## ABSTRACT

Biomass is a renewable source of energy that has an important contribution in reducing the use of conventional fuels and in reducing greenhouse gas emissions to the atmosphere. Densified biomass fuels such as pellets are preferred as they provide better economic viability for transport, storage and handling. Processing biomass and shaping it into pellets allows to convert organic matter into a standard form of fuel, which can be easily obtained, transported and used. The types of biomass used in the production of pellets are quite varied, which affects the physicochemical properties of the final product. For the transformation of vegetal remains into pellets, the pelletization operation is used. The aim of this review is to present the main equipments used in the pelletization process.

## 1. INTRODUCTION

The world's energy markets rely heavily on the fossil fuels coal, petroleum crude oil, and natural gas as sources of thermal energy; gaseous, liquid, and solid fuels; and chemicals. Since millions of years are required to form fossil fuels in the earth, their reserves are finite and subject to depletion as they are consumed. The only natural, renewable carbon resource known that is large enough to be used as a substitute for fossil fuels is biomass [1].

Biomass is a renewable source of energy that has an important contribution in reducing the use of conventional fuels and in reducing greenhouse gas emissions to the atmosphere. In this context, an increasing attention is given to the production and use of environmentally friendly biofuels: pellets and briquettes, biogas, biodiesel and bioethanol. Densified biomass fuels such as pellets are preferred as they provide better economic viability for transport, storage and handling [2]. The pellets have other advantages, such as: a higher energy density, low transportation and storage costs and due to their size and composition, they can be easily used for feeding in domestic and industrial boilers. Processing biomass and shaping it into pellets allows to convert organic matter into a standard form of fuel, which can be easily obtained, transported and used. The types of biomass used in the production of pellets are quite varied, which affects the physicochemical properties of the final product. The main characteristics that determine the quality of pellets are the energy value, the emission of combustion gases (sulphur oxides, nitrogen oxides, hydrogen chloride, volatile dust) and factors that affect proper functioning of furnace [3]. Level of sulphur, chlorine and nitrogen are particularly relevant to the individual recipients, because of the health aspects of consumers and the longevity of heating systems, which are exposed to excessive corrosion.

Several studies have been conducted regarding the pelletizing. Miranda et al.[4] studied pelletizing of forest wastes from oak forest cleaning. Filbakk et al. [5] analyzed the effect of bark content in wild pine pellets by using different proportions of wood and bark, observing better mechanical properties and higher ash percentage in those made from pure bark. Zamorano et al. [6] and García-Maraver et al. [7] assessed the influence of the main pelletizing parameters on different wastes from olive pruning. The aim of this review is to present the main equipments used in the pelletization process.

---

<sup>1</sup>Splaiul Independentei 313, Sector 6, Bucharest, 0744371574, ghvoicu\_2005@yahoo.com

## 2. METHODOLOGY

For the transformation of vegetal remains into pellets, the pelletization operation is used. This is a method of agglomeration, or particle size enlargement, in which material fines are processed into pellets or granules.

Choosing the car pelletizing and power systems, mixing and conditioning of biomass entrance of the car must be made according to the type, range and humidity of the biomass, as well as the way of preparing it in the equipment used before the introduction in the pelletized machine [8]. Pelletizing processes consist of multiple steps (Figure 1) that include raw material pretreatment, pelletization and post-treatment. Pre-treatment technology steps depend a lot on the raw material characteristics and consist generally of size reduction, drying and conditioning. After pelletization, the pellets are transferred into a pellet cooler and screened for small particles [9].

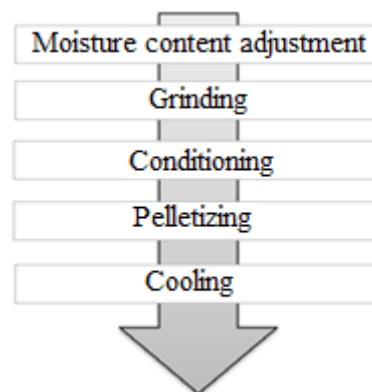

Figure 1: Process stages of biomass pellet production [10]

The schematic of biomass pelleting process is given in Figure 2. The cost of pelleting is mainly dependent on the energy consumption, throughput, and capital costs associated with these unit operations.

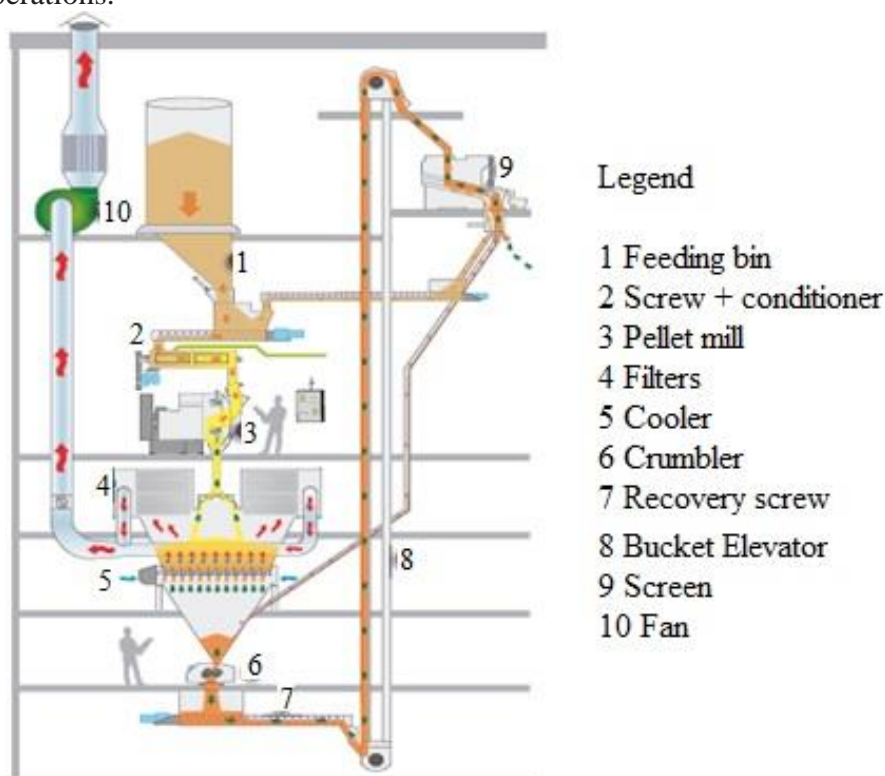

Figure 2: Schematic of the pelletization process [11]

Technoeconomic analysis indicated efficient moisture management is critical for reducing the preprocessing costs of biomass. Sakkampang and Wongwuttanasatian [12] in their study on glycerin-biomass briquettes indicated that drying takes about 2.25 MJ/kg, whereas briquetting takes about 0.05–0.10 MJ/kg for different feedstocks (saw dust, sugarcane bagasse, sugarcane leaf, and rice husk). Yancey et al. [13] indicated that the type of the biomass has an impact on the drying, and pelleting costs. One way to reduce the high drying costs in pellet production process is to pellet biomass at high moistures and then dry the high-moisture pellets using low capital and low temperature drying methods like grain or belt dryer. Studies on pelleting corn stover, ammonia fiber explosion pretreated corn stover, and municipal solid waste at high-moisture content of about >20% in a flat die and ring die pellet mill indicated that good quality pellets, in terms of density and durability, can be produced.

Pellets are produced in a pellet mill that generally consists of a die with cylindrical press channels and rollers that force the biomass to flow into and through the channels. Due to the friction between the steel surface and the biomass in the press channel, a high back pressure is built up and heat is generated. The physical forces built up in the press channel of a pellet mill are crucial for understanding and optimizing the pelletizing process, and have been the subject of multiple studies [14, 15]. A die with press channels and roller(s) are the basic parts of a pellet mill. Figure 3 shows the pelletisation process in a fixed die-casting machine and rotary pressing roller. The die can either be in the shape of a ring or a flat plate.

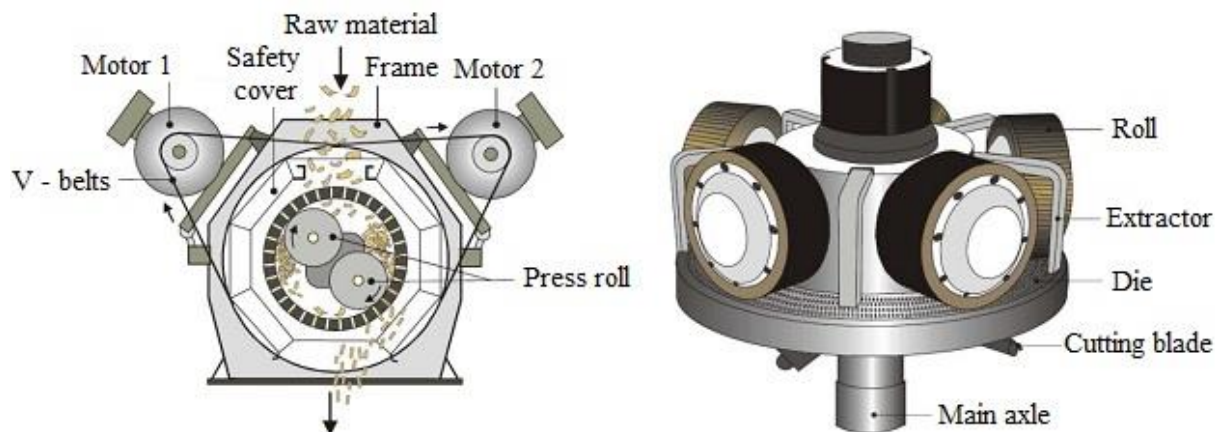

Figure 3: Typical pellet mill design a) ring die and b) flat die [16]

Either the die or the rollers can be rotating, and due to that movement the biomass particles are squeezed into the openings of the press channel.

In figure 4 it's presented the principle of operation of the pressing machine with flat die. The flat-bottomed pelletizer was the first pellet press that was designed at the beginning of the 20th century, based on flat molds. Generally, there are two types of plane molds on the market, the rotary die and the rotating roller. The first type has a stationary roller and a rotary die, and the second type has a stationary die, while the roller rotates. By adopting the vertical principle, the raw material falls by its own weight in the pelletizing chamber where it is compressed between the rollers and the mold forming the pellets by passing through the mold holes. On the whole, flat-bed pelletisers are generally used to process materials with high adhesion forces to produce both pellets for both fuel and animal feed, on a small and medium scale. They are known due to their features such as safe operation, high mobility, low noise, low energy consumption, and low productivity compared to the ring-shaped pelletizer.

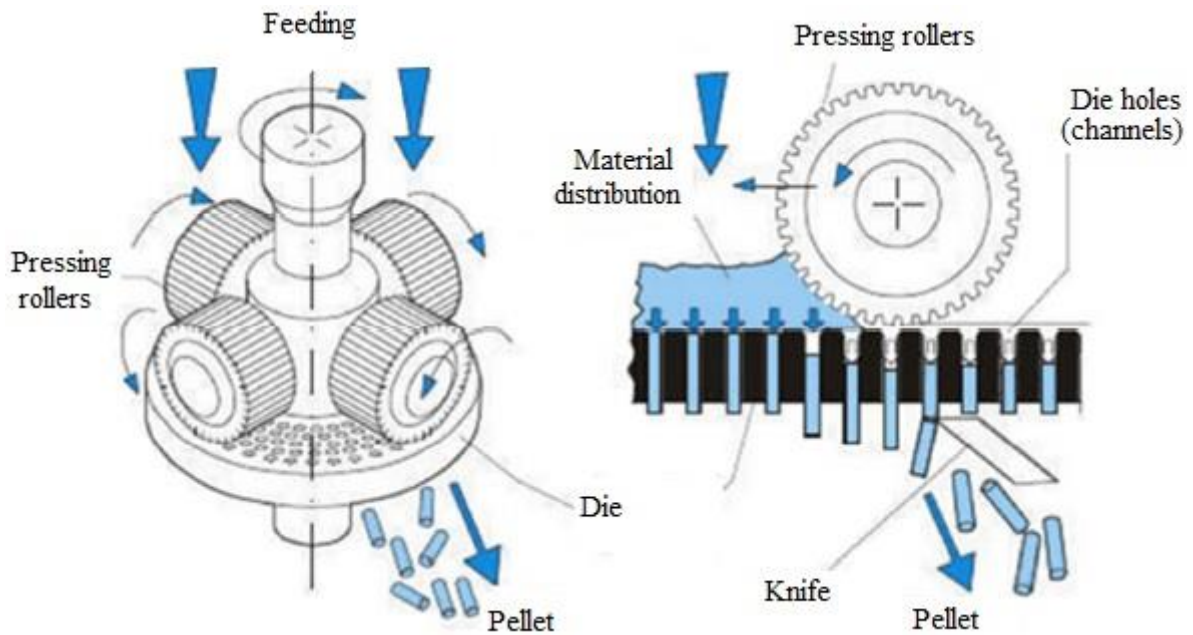

Figure 4: The operating principle of the flat die press machine [17]

Figure 5 shows the process of forming the pellets in the flat mold of the ECO-10 installation. The ECO-10 flat die pellet mill incorporates the same simple and economical belt drive system, and it is built to withstand heavy to severe duty applications. The ECO-10 is equipped with a 13-phase motor, and an optional variable speed drive is available. This unit is rated at 30 to 150 lbs per hour, depending on material, and is intended for research and development, pilot scale, as well as small production scale applications.

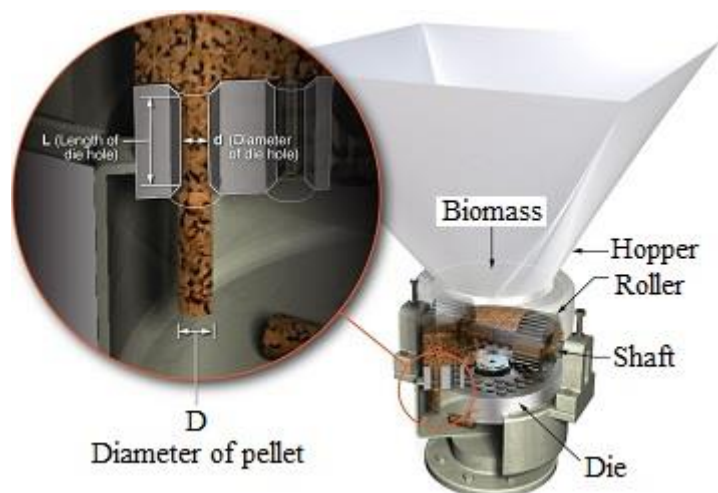

Figure 5: Schematic showing expansion of the high moisture pellet during compression and extrusion in a flat die pellet mill [18]

In the flat-bottomed pellet machine of Figure 6, the biomass hopper and auger conveyor for biomass feed are equipped with flexible tape type heating, temperature regulators and thermocouples for preheating biomass. The die and the snail are equipped with a variable frequency unit to control the rotational speed of the die and to adjust the feed rate in the mill. Horizontal cooler is designed to cool the hot pellets immediately after their exit from the mold. Both the hopper and feeder are provided with flexible heating tape and J-type

thermocouples and controllers to preheat the biomass both in the hopper and the feeder at a constant temperature. The die of the pellet mill is provided with a variable frequency drive to control the rotational speed of the die.

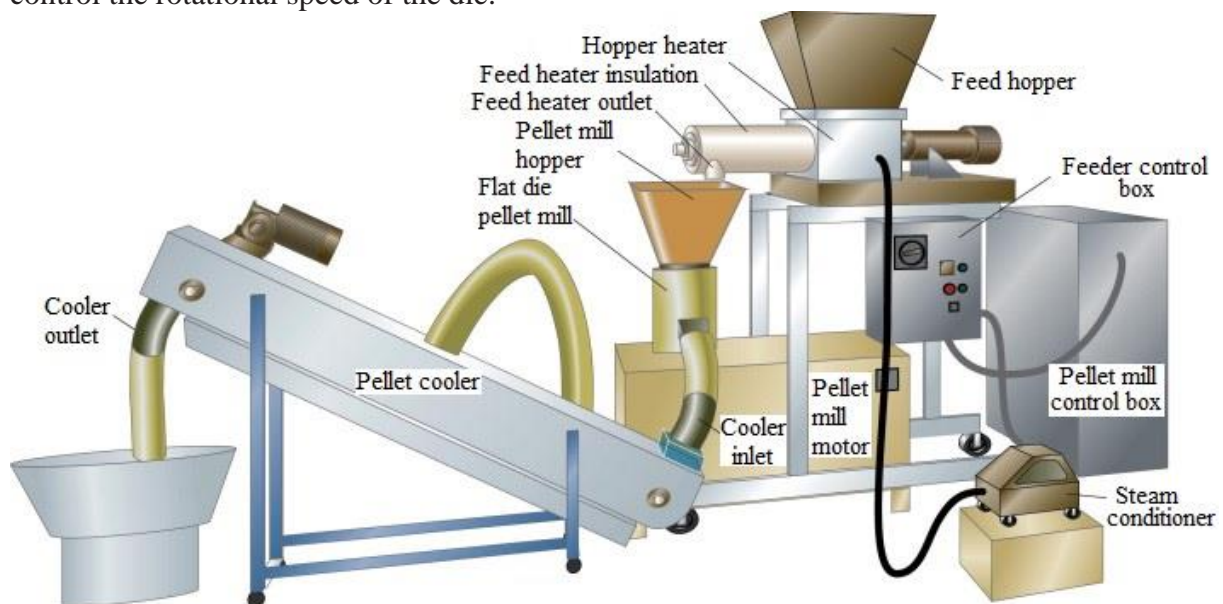

Figure 6: Flat-die pellet mill [19]

The main factor, based on which the most suitable method of pelleting can be selected, is the specificity of the finished product for the finished granular product. The granulometric composition and the form of primary particles and granules as well as the requirements for the use of binders in the agglomeration process also represent a number of criteria on the basis of which one may choose to adopt a particular pelletization process.

The characteristics and condition of the primary material, in turn, are criteria for choosing the agglomeration method, and if the primary material is in paste form, the extrusion granulation process is used. If the primary materials are sensitive to moisture (they are slightly soluble), the dry compaction method is used by pressing.

### 3. CONCLUSIONS

Densified biomass fuels such as pellets are preferred as they provide better economic viability for transport, storage and handling. Processing biomass and shaping it into pellets allows to convert organic matter into a standard form of fuel, which can be easily obtained, transported and used.

For the transformation of vegetal remains into pellets, the pelletization operation is used. This is a method of agglomeration, or particle size enlargement, in which material fines are processed into pellets or granules.

The characteristics and condition of the primary material, in turn, are criteria for choosing the agglomeration method, and if the primary material is in paste form, the extrusion granulation process is used. If the primary materials are sensitive to moisture (they are slightly soluble), the dry compaction method is used by pressing.

### ACKNOWLEDGEMENTS

This work was funded by the Executive Agency for Higher Education, Research, Development and Innovation Funding, within the project entitled "Optimizing the



composition of biomass mixtures for obtaining high quality pellets", ctr. 24 BG / 2016 (code PN-III-P2-2.1-BG-2016-0266), Romania.

## References

- [1] DONALD L. KLASS Entech International, Inc. Barrington, United States *Biomass for Renewable Energy and Fuels*, 2004
- [2] I. Obernberger, G. Thek, Physical characterisation and chemical composition of densified biomass fuels with regard to their combustion behaviour, *Biomass Bioenergy* 27 (2004) 653–669.
- [3] Hiegl W., Janssen R., Pichler W. (2009), *Advancement of pellets-related European standards*, WIP Renewable Energies, Munich/Vienna, <http://bape.com.pl/LinkClick.aspx?fileticket=zv64RqEj-5E%3D&tabid=312&mid=697>
- [4] Miranda, M.T.; Arranz, J.I.; Rojas, S.; Montero, I. Energetic characterization of densified residues from Pyrenean oak forest. *Fuel* 2009, 88, 2106–2112
- [5] Filbakk, T.; Jirjis, R.; Nurmi, J.; Hoibo, O. The effect of bark content on quality parameters of Scots pine (*Pinus sylvestris* L.) pellets. *Biomass Bioenergy* 2011, 35, 3342–3349
- [6] Zamorano, M.; Popov, V.; Rodríguez, M.L.; García-Maraver, A. A comparative study of quality properties of pelletized agricultural and forestry logging residues. *Renew. Energy* 2011, 36, 3133–3140
- [7] García-Maraver, A.; Rodríguez, M.L.; Serrano-Bernardo, F.; Díaz, F.; Zamorano, M. Factors affecting the quality of pellets made from residual biomass of olive trees. *Fuel Process. Technol.* 2015, 129, 1–7.
- [8] Vlăduț, V., Danciu, A., Nicolescu, M., Postelnicu, E., *Tehnologii pentru obtinerea si utilizarea biomasei*, Editura Terra Nostra, Iași, 2002.
- [9] Obernberger, I.; Thek, G. In: *The pellet handbook - The production and thermal utilisation of biomass pellets*; Earthscan: London, 2010
- [10] Larsson, S. H. In: *Fuel pellet production from reed canary grass - Supply potentials and process technology*. PhD thesis, Swedish University of Agricultural Science: Umeå, 2008.
- [11] Alakangas, E.; Paju, P. In: *Wood pellets in Finland, technology, economy and market*. OPET 5 report. VTT Technical Research Centre of Finland: Espoo, 2002.
- [12] Sakkampang, C., Wongwuttanasatian, T., 2014. Study of ratio of energy consumption and gained energy during briquetting process for glycerin –biomass briquette fuel. *Fuel*. 115, 186–189
- [13] Yancey, N., Tumuluru, J. S., Wright, C. T., 2013. Grinding and densification studies on raw and formulated woody and herbaceous biomass feedstocks, *Journal of Biobased Materials and Bioenergy*. 7, 549–558.
- [14] Holm, J. K.; Henriksen, U. B.; Wand, K.; Hustad, J. E.; Posselt, D. Experimental verification of novel pellet model using a single pelleter unit. *Energy & Fuels*. 2007
- [15] Stelte, W.; Holm, J. K.; Sanadi, A. R.; Ahrenfeldt, J.; Henriksen, U. B. Fuel pellets from biomass: the importance of the pelletizing pressure and its dependency on the processing conditions. *Fuel*. 2011, 90, 3285-3290.
- [16] FAO. 1980. Fish feed technology, Lectures presented at the FAO/UNDP Training Course in Fish Feed Technology, held at the College of Fisheries, University of Washington, Seattle, Washington, U.S.A., 9 October-15 December 1978, United Nations Development Programme, Food and Agriculture Organization of the United Nations, Rome, ADCP/REP/80/11.
- [17] *Ghid pentru furnizorii de bio-combustibil*, Proiect de energie și biomasă în Moldova, 2012;
- [18] Jaya Shankar Tumuluru, Specific energy consumption and quality of wood pellets produced using high-moisture lodgepole pine grind in a flat die pellet mill, INL/JOU-15-34655, 2015.
- [19] Amber N. Hoover, Jaya Shankar Tumuluru, Farzaneh Teymouri, Janette Moore, Garold Gresham *Effect of pelleting process variables on physical properties and sugar yields of ammonia fiber expansion pretreated corn stover*, *Bioresource Technology* 164 (2014) 128–135

# WASTEWATER DISINFECTION BY CHLORINATION, OZONATION AND ULTRAVIOLET (UV) – A REVIEW

Bianca-Ştefania ZĂBAVĂ<sup>1</sup>, Gheorghe VOICU, Gigel PARASCHIV, Mirela DINCĂ,  
Nicoleta UNGUREANU, Mariana IONESCU  
Politehnica University of Bucharest, Faculty of Biotechnical Systems Engineering, Romania

## ABSTRACT

Human exposure to wastewater discharged into the environment has increased within the past 15 to 20 years with the rise in population and the greater demand for water resources for recreation and other purposes. The organisms of concern in domestic wastewater include enteric bacteria, viruses, and protozoan cysts. Disinfection is considered to be the primary mechanism for the inactivation/ destruction of pathogenic organisms to prevent the spread of waterborne diseases to downstream users and the environment. The aim of this paper is to present the main types of disinfection used for the treatment of wastewater containing microorganisms.

## 1. INTRODUCTION

Human exposure to wastewater discharged into the environment has increased within the past 15 to 20 years with the rise in population and the greater demand for water resources for recreation and other purposes. The organisms of concern in domestic wastewater include enteric bacteria, viruses and protozoan cysts [1]. Untreated and secondary treated effluent contains a range of pathogenic microorganisms that pose a potential risk to the health of humans and livestock. Bacteria are the most common microbial pathogens found in wastewater. They are often used as an indicator of pathogen contamination and as a surrogate indicator to assess the efficacy of treatment and disinfection methods. However, as bacteria are generally the most sensitive group to disinfection and have high infective doses, they present a relatively low health risk [2].

Treating dirty water, whether it comes from sewage lines or a chemically polluted lake, costs a relative fortune. If a poor country, and especially small villages in that country, can't afford to produce clean drinking water, they certainly can't afford to produce clean water for irrigation purposes. For example, in poor villages, farmers use water from rivers polluted with sewage or runoff from livestock farms, industry and other contaminated sources to irrigate their cropland. This allows bacteria make it into the food, and people and animals who live off this produce can become ill [3].

Disinfection is considered to be the primary mechanism for the inactivation/ destruction of pathogenic organisms to prevent the spread of waterborne diseases to downstream users and the environment. The three most common methods of disinfection in the U.S. are chlorination, ozonation, and ultraviolet (UV) disinfection. All three disinfection methods described above can effectively meet the discharge permit requirements for treated wastewater. It is important that wastewater be adequately treated prior to disinfection in order for any disinfectant to be effective. However, the advantages and disadvantages of each must be weighed when selecting a method of disinfection [4]. In the following, there are presented these three most commonly used types of disinfection.

---

<sup>1</sup> Splaiul Independentei 313, Sector 6, Bucharest, 0731538941, bianca.dragoiu@yahoo.com

## 2. METHODOLOGY

Prior to discharging into the environment, wastewater is disinfected to ensure pathogens are inactivated for environmental and human safety reasons [5].

### *Chlorination*

Chlorine is one of the most practical and widely used disinfectants for wastewater. However, effluent chlorination results in the formation of mutagenic/ carcinogenic disinfection by products (DBPs) deriving from the reaction of the chlorine with organic compounds in wastewater [6]. Therefore, dechlorination followed by chlorination should be done, or alternative safe disinfectant should be used.

Chlorine may be applied in a number of forms such as chlorine gas, sodium hypochlorite or chlorine dioxide [7]:

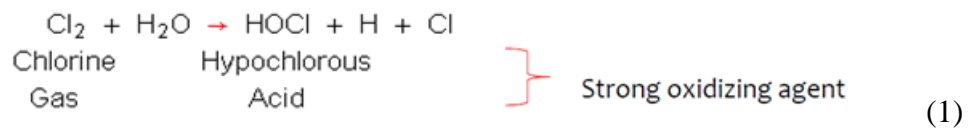

The advantages of using chlorination are: chlorine is reliable and effective against a wide spectrum of pathogenic organisms; chlorine is more cost-effective than UV or ozone disinfection; the chlorine residual that remains in the wastewater effluent can prolong disinfection even after initial treatment and can be measured to evaluate the effectiveness; dosing rates are flexible and can be controlled easily. Like any other method, chlorination also has some disadvantages, such as: the chlorine residual is toxic to aquatic life and the system may require dechlorination, even when low concentrations of chlorine are used; all forms of chlorine are highly corrosive and toxic; chlorine reacts with certain types of organic matter in wastewater, creating hazardous compounds.

Chlorine dosage may be established from either bench scale laboratory testing, or actual measurement of field results from known plant operation [8].

### *Ozonation*

Ozone has been proved to be one of the most effective disinfectants and is widely used to inactivate pathogens in drinking water, especially in Europe, USA and Canada [9]. Ozone is an unstable gas that can destroy bacteria and viruses. It is formed when oxygen molecules (O<sub>2</sub>) collide with oxygen atoms to produce ozone (O<sub>3</sub>). Ozone is generated by an electrical discharge through dry air or pure oxygen and is generated on site because it decomposes to elemental oxygen in a short amount of time. After generation, ozone is fed into a down-flow contact chamber containing the wastewater to be disinfected. From the bottom of the contact chamber, ozone is diffused into fine bubbles that mix with the downward flowing wastewater. Ozonation process diagram is shown in Figure 1. Ozone disinfection is generally used at medium- to large-sized plants after at least secondary treatment.

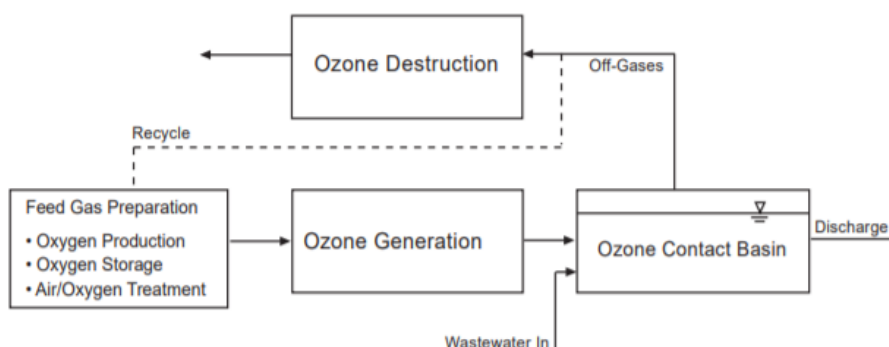

Figure 1: Ozone disinfection process diagram [10]

The most important benefits of using ozone are: ozone is more effective than chlorine in destroying viruses and bacteria; the wastewater needs to be in contact with ozone for just a short time (approximately 10 to 30 minutes); there is no regrowth of microorganisms after ozonation, unlike ultraviolet and chlorine disinfection. The disadvantages of this method of disinfection are: low dosages may not effectively inactivate some viruses, spores, and cysts; ozonation is more complex than other disinfection technologies; ozone is very reactive and corrosive, thus requiring corrosion-resistant material, such as stainless steel; ozonation is not economical for poor quality (poorly treated) wastewater [11].

#### *Ultraviolet (UV) disinfection*

The disinfection of treated wastewater via ultraviolet (UV) radiation is a physical process that principally involves passing a film of wastewater within close proximity of a UV source (lamp). The efficiency of UV disinfection depends on the physical and chemical water quality characteristics of the wastewater prior to disinfection. With a better quality of wastewater comes a more efficient UV disinfection process [2].

A UV disinfection system transfers electromagnetic energy from a mercury arc lamp to an organism's genetic material (DNA and RNA) – figure 2. When UV radiation penetrates the cell wall of an organism, it destroys the cell's ability to reproduce. The effectiveness of a UV disinfection system depends on the characteristics of the wastewater, the intensity of UV radiation, the time the microorganisms are exposed to the radiation, and the reactor configuration. For any one treatment plant, disinfection success is directly related to the concentration of colloidal and particulate constituents in the wastewater. The main components of a UV disinfection system are mercury arc lamps, a reactor, and ballasts. The source of UV radiation is either the low-pressure or medium-pressure mercury arc lamp with low or high intensities.



Figure 2: A UV disinfection system [12]

The cost of UV disinfection systems is dependent on the manufacturer, the site, the capacity of the plant, and the characteristics of the wastewater to be disinfected. Total costs of UV disinfection can be competitive with chlorination when the dechlorinating step is included. The advantages of this method are: UV disinfection is effective at inactivating most viruses, spores, and cysts. There is no residual effect that can be harmful to humans or aquatic life; UV disinfection is user-friendly for operators; UV disinfection equipment requires less space than other methods. The disadvantages are: low dosages may not effectively inactivate some viruses, spores, and cysts; organisms can sometimes repair and reverse the destructive effects of UV through a “repair mechanism,” known as *photo reactivation*, or in the absence of light known as “dark repair.”; a preventive maintenance program is necessary to control

fouling of tubes; turbidity and total suspended solids (TSS) in the wastewater can render UV disinfection ineffective [12].

### ACKNOWLEDGEMENT

This work has been funded by the Ministry of National Education and Research, through the UEFISCDI, within the project entitled „Innovative technologies for crop irrigation in arid, semi-arid and sub-dry climate", contract no. 27 PCCDI / 2018.

### 3. CONCLUSIONS

Disinfection is considered to be the primary mechanism for the inactivation/ destruction of pathogenic organisms to prevent the spread of waterborne diseases to downstream users and the environment. The three most common methods of disinfection in the U.S. are chlorination, ozonation, and ultraviolet (UV) disinfection.

Chlorine is one of the most practical and widely used disinfectants for wastewater. The dosage of that may be established from either bench scale laboratory testing, or actual measurement of field results from known plant operation. Chlorine is more cost-effective than UV or ozone disinfection.

Ozone has been proved to be one of the most effective disinfectants and is widely used to inactivate pathogens in drinking water, especially in Europe, USA and Canada. Ozone is generated by an electrical discharge through dry air or pure oxygen and is generated onsite because it decomposes to elemental oxygen in a short amount of time.

The disinfection of treated wastewater via ultraviolet (UV) radiation is a physical process that principally involves passing a film of wastewater within close proximity of a UV source (lamp). The efficiency of UV disinfection depends on the physical and chemical water quality characteristics of the wastewater prior to disinfection.

### References

- [1] Crites, R. and Tchobanoglous, G., *Small and Decentralized Wastewater Management Systems*. The McGraw-Hill Companies. New York, New York, 1998.
- [2] *Guidelines for environmental management disinfection of treated wastewater*, EPA Victoria 40 City Road, Southbank Victoria 3006 AUSTRALIA Publication 730 ISBN 0 7306 7623 4, 2002.
- [3] <https://science.howstuffworks.com/environmental/earth/geophysics/wastewater-agriculture.htm>
- [4] *Ultraviolet Disinfection Project funded by the U.S. Environmental Protection Agency under Assistance Agreement No. CX824652*
- [5] U.S. Environmental Protection Agency, Office of Water Washington, D.C., EPA 832-F-99-064, 1999.
- [6] Sun, YX, Wu, QY, Hu, HY, Tian, J., *Effects of operating conditions on THMs and HAAs formation during wastewater chlorination*. J Hazard Mater;168:1290-1295, 2009.
- [7] <http://www.yourarticlelibrary.com/waste-management/advanced-waste-water-treatment-methods-waste-management27495>
- [8] *Wastewater Treatment Plant Operator Certification Training, Module 5: Disinfection and Chlorination*, [http://files.dep.state.pa.us/Water/BSDW/OperatorCertification/TrainingModules/ww05\\_disinfection\\_chlorinati\\_wb.pdf](http://files.dep.state.pa.us/Water/BSDW/OperatorCertification/TrainingModules/ww05_disinfection_chlorinati_wb.pdf), 2016.
- [9] Xu, P., Janex, M.-L., Savoye, P., Cockx, A., Lazarova, V., *Wastewater Disinfection by Ozone: Main parameters for Process Design*. Water Res., 36(4), 1043-1055, 2002.
- [10] U.S. Environmental Protection Agency (EPA). *Design Manual: Municipal Wastewater Disinfection*. EPA Office of Research and Development. Cincinnati, Ohio. EPA/625/1-86/021. 1986.
- [11] *Ozone Disinfection Project funded by the U.S. Environmental Protection Agency under Assistance Agreement No. CX824652* ETI Environmental Technology Initiative Fact Sheet A General Overview, available at [http://www.nesc.wvu.edu/pdf/WW/publications/eti/Ozone\\_Dis\\_gen.pdf](http://www.nesc.wvu.edu/pdf/WW/publications/eti/Ozone_Dis_gen.pdf)
- [12] *Ultraviolet Disinfection Project funded by the U.S. Environmental Protection Agency under Assistance Agreement No. CX824652*.

# FACTORS THAT INFLUENCE THE EFFICIENCY OF THE DECANTING PROCESS– A REVIEW

Bianca-Ştefania ZĂBAVĂ<sup>1</sup>, Gheorghe VOICU, Mirela DINCĂ, Nicoleta UNGUREANU, Mariana FERDEŞ  
Politehnica University of Bucharest, Faculty of Biotechnical Systems Engineering, Romania

## ABSTRACT

Sedimentation is perhaps the oldest and most common water treatment process. On the surface, a sedimentation tank appears to be a simple phase separating device, but down under an intricate balance of forces is present. Many factors clearly affect the capacity and performance of a sedimentation tank: surface and solids loading rates, tank type, solids removal mechanism, inlet design, weir placement and loading rate. Sedimentation (settling) is the separation of suspended particles that are heavier than water. Sedimentation is widely used in wastewater treatment systems. This paper presents the results obtained in some research focused on wastewater decanting processes in settling tanks.

## 1. INTRODUCTION

Industrially used water, also called „waste water” or „residual water” comes from different production and processing processes, from a physical point of view, they represent multiphase fluids (mixtures). When stopping, the phases are separated by gravity by a downward movement (gravimetric separation), due to the differences in specific mass of the particles in the suspension, thus achieving a sedimentation or decantation process [1].

Enhancing the efficiency of the settling tanks is one of the most economical approaches for refining water. On the surface, a sedimentation tank appears to be a simple phase separating device, but down under an intricate balance of forces is present. Many factors clearly affect the capacity and performance of a sedimentation tank: surface and solids loading rates, tank type, solids removal mechanism, inlet design, weir placement and loading rate [2]. Experimental and numerical investigations show that the performance of the sedimentation basins is influenced by velocity field variations and the geometry of the tank, especially, the location of the inlet, medium and outlet baffles. Sedimentation tanks are divided into two main categories in type and concentration of sludge and particles which are available in them. Primary settling tanks have low influent concentration. Flow field in them is not much influenced by concentration field and buoyancy effects can be negligible. Secondary or final-settling tanks have higher influent concentration. They usually are placed after primary tanks and activation tanks [3]. Depending on the type and concentration of the dispersed solid particles as well as on their tendency of agglomeration, the decanting process of the mixtures takes place in four distinctive ways [4]: type I sedimentation, applicable in the case of granulated solid particles; type II sedimentation characteristic for particles tending to agglomerate; type III- mass sedimentation; type IV- compacting or settling.

Krebs (1995) investigated the effects of the inlet and intermediate baffles on the flow field in final clarifiers. His research was mainly based on experiments, numerical modeling as well as on analytical relations [6]. Zărnoianu D. et al. have made a research focused on wastewater decanting processes in a pilot test rig using 3 constructive variants of decanters: with tangential inlet and free exit, with tangential inlet and a discharge threshold and with deflection plates and a discharge threshold, respectively. The results showed that the best efficiency is that of the decanter with deflection plate [7].

---

<sup>1</sup> Splaiul Independentei 313, Sector 6, Bucharest, 0731538941, bianca.dragoiu@yahoo.com

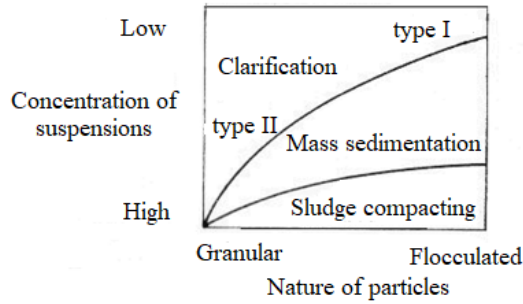

Figure 1: Decantation phases [5]

This paper presents the results obtained in some research focused on wastewater decanting processes in settling tanks.

## 2. METHODOLOGY

Enhancing the efficiency of the settling tanks is one of the most economical approaches for refining water. There are many works that have been published regarding simulation of settling process. The most representative are presented below

Margarita Jover-Smet et al. have made a study for the purpose to obtain a greater understanding of the influence of operational parameters, such as surface overflow rate, hydraulic retention time, and temperature, on the removal efficiency of suspended solids and organic matter by the measurement of chemical oxygen demand (COD) and biochemical oxygen demand (BOD<sub>5</sub>) in the primary sedimentation process. The research was carried out in a semi-technical primary settling tank which was fed with real wastewater from a wastewater treatment plant. The physical process was strictly controlled and without the intervention of chemical additives. As a first step in analyzing the performance data it was decided to obtain an efficiency-overflow rate relationship. The removal efficiency (E) of SS, COD and BOD<sub>5</sub>, obtained in the process at different surface overflow rates, is indicated in Figure 2.

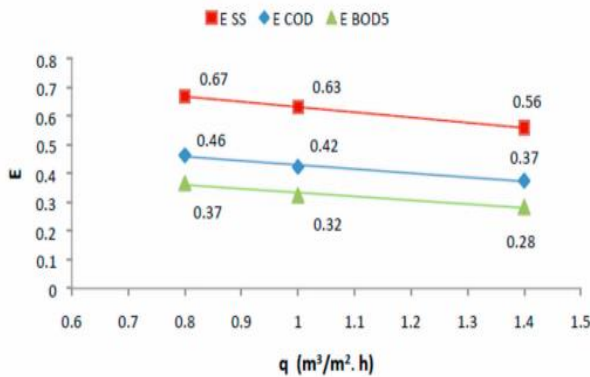

Figure 2: Effect of q on SS, COD and BOD5 Efficiency [8]

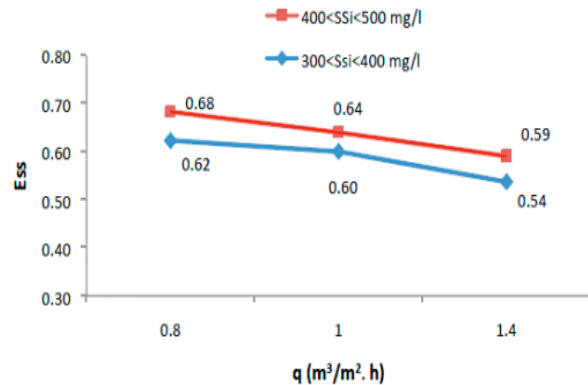

Figure 3: Efficiency at Different SSi Ranges [8]

The second analysis, as shown in Figure 3, was performed on the original data grouped into SS influent (SSi) ranges (300–400 mg/L and 400–500 mg/L). It can also be observed that the SS concentration influent (SSi) had an effect on the removal efficiency, since flocculation is more significant at higher SS levels, different authors have described the same influence.

The results obtained show that the elimination efficiency can be increased by 11% for SS and 9% for chemical oxygen demand and biochemical oxygen demand, for variations in the surface overflow rate of around  $\pm 0.6 \text{ m}^3/\text{m}^2 \cdot \text{h}$  and variations in hydraulic retention time of around  $\pm 2 \text{ h}$  [8].

Podoleanu E. has studied programs that indicate the process of sedimentation of longitudinal horizontal decanters and their efficiency. Experimental measurements were made at plant no. 4 of Timisoara and the Water Treatment Laboratory at the Hydraulic Engineering Faculty (in terms of suspension mass dependence according to the turbidity of the water) during spring and summer of 2006 (at various flows and turbidity). Mass suspension of existing in different water samples was determined using two methods of working. The first method consisted of filtering a volume of 1 liter of water on a filter paper (HF) and then HF with suspensions remaining on HF were dried in the oven until complete evaporation of water (3 hours at 105°C). The second approach, considered safer, with less errors and faster is that to measure water volume (1 liter) and placing it in a special dish in the oven for complete evaporation of water. The results obtained were analyzed using a *polifit* function of Matlab program that approximates a data set with a polynomial of degree n, were plotted distribution curves of concentration at different depths (H) on basin length (L). After running the program have obtained curves of the graph in Figure 4.

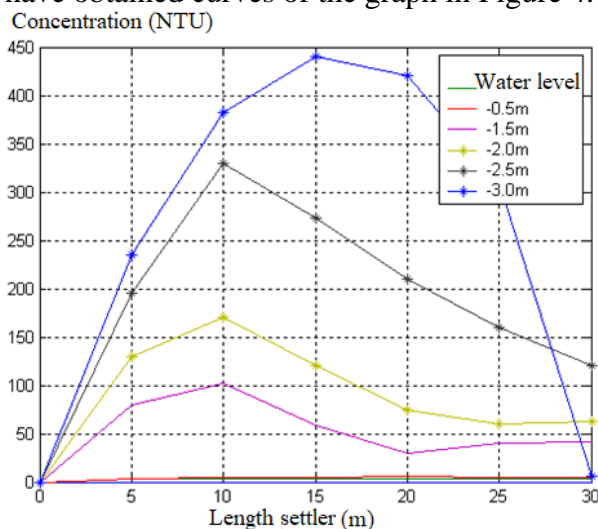

Figure 4: Changes in concentration depending on the length of the settling tank to different depths [9]

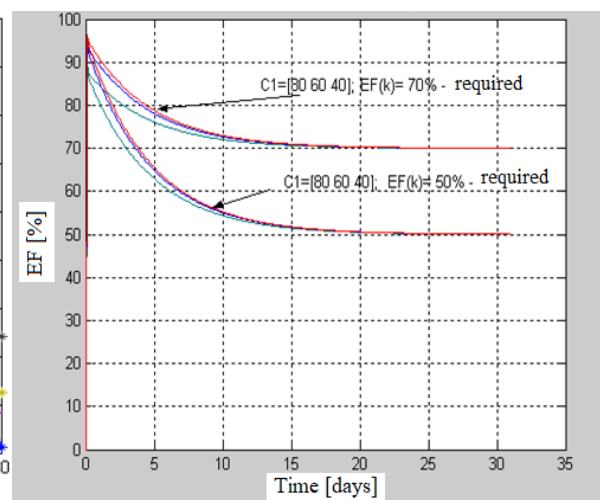

Figure 5: Efficiency variation in time of the settling tank [9]

To calculate the settling tank efficiency have done a program *efficient.m* in Matlab in that are defined the following: geometric parameters of the settling tank,  $H_n$  and  $C_n$ ,  $T$  - time constant of the process,  $K_r$ -amplification factor of regulator,  $T_i$  - time constant integration of the regulator for PI (PID) case is taken 0.1, the period in which we study EF [%], set EF [%] before settling tank to work, introduce input concentrations  $C_1 = [80 \ 60 \ 40]$ ,  $EF(k) = 70\%$  - is required  $C_1 = [80 \ 60 \ 40]$ ,  $EF(k) = 50\%$  is required. The result of running the program is shown in Figure 5.

From graphic analysis of concentration distribution (Figure 5) the conclusion is that in the first half of the settling tank is an intensification of sedimentation processes of floaters influenced by the water distribution system in the settling tank. So it can say that the thickness of the deposits of mud in studied settling tank it's in the first half of this, which is visually checked at the clearing and washing of the settling tank [9].

The experimental investigations of Taeby-Harandy and Schroeder (1995) on primary decanters have shown that placement of an intermediate sicane, installed near the middle of the decanter and extended from the radiator up to a depth of one third, had no significant effect on efficiency decantation. They believed that the difference between the outcome of their studies and the other works is probably due to the difference in flow patterns in the sense



that if the dominant current is a surface current, a surge that extends from the top may improve the removal efficiency of solids [10].

### 3. CONCLUSIONS

Enhancing the efficiency of the settling tanks is one of the most economical approaches for refining water. Sedimentation is perhaps the oldest and most common water treatment process.

There are many works that have been published regarding simulation of settling process. Margarita Jover-Smet et al. have made a study for the purpose to obtain a greater understanding of the influence of operational parameters. The results obtained show that the elimination efficiency can be increased by 11% for SS and 9% for chemical oxygen demand and biochemical oxygen demand, for variations in the surface overflow rate of around  $\pm 0.6 \text{ m}^3/\text{m}^2 \cdot \text{h}$  and variations in hydraulic retention time of around  $\pm 2 \text{ h}$ . Another study uses some programs that indicate the process of sedimentation of longitudinal horizontal decanters and their efficiency. It was found conclusion that in the first half of the settling tank is an intensification of sedimentation processes of floaters influenced by the water distribution system in the settling tank.

### ACKNOWLEDGEMENT

This work has been funded by the Ministry of National Education and Research, through the UEFISCDI, within the project entitled „Innovative technologies for crop irrigation in arid, semi-arid and sub-dry climate", contract no. 27 PCCDI / 2018.

### References

- [1] Daniela Zârnoianu, Simion Popescu, Carmen Brăcăcescu *Theoretical and experimental research on the separation process of impurities from waste water through decantation*, 6th International Conference Computational Mechanics and Virtual Engineering, COMEC, 2015, Braşov, Romania
- [2] A. H. Ghawi, J. Kriš “*A Computational Fluid Dynamics Model of Flow and Settling in Sedimentation Tanks*”, Slovak University of Technology, Slovakia, 2005
- [3] A. Razmi1, B. Firoozabadi1, and G. Ahmadi, *Experimental and Numerical Approach to Enlargement of Performance of Primary Settling Tanks*, Journal of Applied Fluid Mechanics, Vol. 2, No. 1, pp. 1-12, 2009
- [4] Robescu, Diana et al. *Tehnici de epurare a apelor uzate*, Editura Tehnica, Bucuresti, 2011
- [5] Safta, V.V., Toma, M.L., Ungureanu, N., *Experiments in water treatment domain*, PRINTECH Publishing, 2012
- [6] Krebs, P. (1995). Success and shortcomings of clarifier modeling. *Journal of Water Science and Technology* 31(2), 181-191
- [7] Zârnoianu Daniela, PhD Student,1 Prof. Simion Popescu, Marin Radu, *The influence of constructive factors and working conditions of decanters on wastewater processing efficiency*, 3rd International Conference - Research & Innovation in Engineering - COMAT 2014 16- 17 October 2014, Brasov, Romania
- [8] Margarita Jover-Smet , Jaime Martín-Pascual and Arturo Trapote, *Model of Suspended Solids Removal in the Primary Sedimentation Tanks for the Treatment of Urban Wastewater*, 2017
- [9] Podoleanu Corneliu Eusebiu - *Optimization of the longitudinal horizontal settling tanks exploitation within a drinking surface water stations*, Buletinul Ştiinţific al Universităţii "POLITEHNICA" din Timişoara, Tom 55(69), Fascicola 2, 2010
- [10] Taebi-Harandy, A. and E.D. Schroeder, 1995. 33. Khademi, M., M.H. Omid and A. Hourfar, 2007. *Analysis of structural features on performance of Experimental and numerical investigation of the secondary clarifiers*. Journal of Environmental effect of submerged baffle on the trap efficiency, Engineering, 121(12): 911-919

# MODELING RENEWABLE ENERGY SHARE DYNAMICS

Dana-Alexandra Ciupăgeanu, Gheorghe Lăzăroiu  
University Politehnica of Bucharest

## ABSTRACT

Accurate forecasts of electricity demand are extremely important to achieve successful energy management considering the continuously increasing uncertainty of power generation, due to the steady growth of renewable energy share. This article proposes a state space model for an energy system, based on momentary recordings of generation and consumption for the past decade in Romania, as a first order linear dynamic system. The variables taken into account as inputs were the ambient temperature, insolation, wind speed and demand records. System's state a certain moment is defined by the share of renewable energy sources in meeting electricity demand, and its output is regarded as total power generation within the grid. Data processing and system identification were performed employing Matlab software; transfer functions for each input are presented. According to the results obtained, the described system is naturally stable in some hypothesis, the poles of the transfer functions having a negative real part.

## 1. INTRODUCTION

Fluctuant power generation sources integration causes the electricity supply to exhibit unprecedented challenges in meeting demand, their volatility overlapping the intermittency of consumption. Even so, many states facilitate rising renewable energies share by unfailingly promoting eco friendly energy policies, facing electricity retailers to the uncertainty of matching generation and demand. European Union targets a 20% renewables share in energy consumption by the end of 2020 [1].

A possible way to mitigate the effects of power fluctuations, to which research interest in the area focuses lately is through demand response [2], [3]. This sort of approach requires a complex and efficient monitoring infrastructure, wide databases to assess electricity demand patterns for each category of consumer connected to the grid depending on several variables, such as ambient temperature [3], [4]. Based on this information, possible load reductions and their financial and technical advantages can be estimated for different time horizons [2].

Power demand flexibility may be considered similar to functional energy storage, with the charging capacity determined by the flexible load and the maximum duration of the intervention, reflecting the change in normal demand pattern. Various sectors of the market can differently contribute in demand response, studies carried out on this regard being actually numerous [2], [3].

Still, due to constraints of technical, economic and social nature, large scale implementation of demand response is currently confined. Hence, in the perspective of widespread deployment of efficient solutions such as those mentioned above, modeling and simulation of energy systems can provide useful information regarding their steady and dynamic behavior characteristics [1-3]. Furthermore, simulations results help spotting variables which influence most the output or disturb the control objectives [4], [5].

Given the potential increasing discrepancies between power supply and demand, modeling theirs both dynamics is particularly useful. This paper introduces a state-space modeling approach to assess the unsteady behavior of electricity demand and renewable energy production interaction, without any control. The study relies on historical records for the past decade from Romanian power system [6].

## 2. METHODOLOGY

### 2.1. Primary data processing

Based on the momentary recordings of electricity generation by sources (coal, hydrocarbons, hydro, nuclear, wind energy, photovoltaic and biomass) and consumption a first data set was built, by concatenating all records. The renewable energy share in meeting electricity demand at each time step, further considered to define the state of the dynamic system, resulted by adding the registrations for renewable sources power production and dividing the sum thus obtained by the corresponding demand.

According to previous approaches of demand dynamics modeling and renewable energy forecasting presented in scientific literature [7], [8], we considered the following inputs of the model system: insolation, wind speed, ambient temperature (as meteorological factors interfering with the renewable energy plants output) and electricity demand, as the representative quantity of the power system. The last input variable establishes the necessary of energy to be generated, which we have considered dynamic system's output.

In order to match input vector dimensions to the state vector (since the records from the power system had an average time resolution of 10 minutes, totaling 473651 elements, and the climatic ones were on hourly basis) a re-sampling of available data for temperature, wind speed and insolation was needed.

Dynamic modeling requires knowing the coefficient matrices that fit the behavior of the system having certain input and output in each state. In this research, starting from the state of the system, its first order time derivative and the matching inputs and output we aim to calculate the coefficient matrices, as it shall be presented in the following section.

### 2.2. System identification

As described above, the dynamic system state is described at each moment by the renewable energy share in meeting electricity demand, Figure 1 illustrating its block diagram.

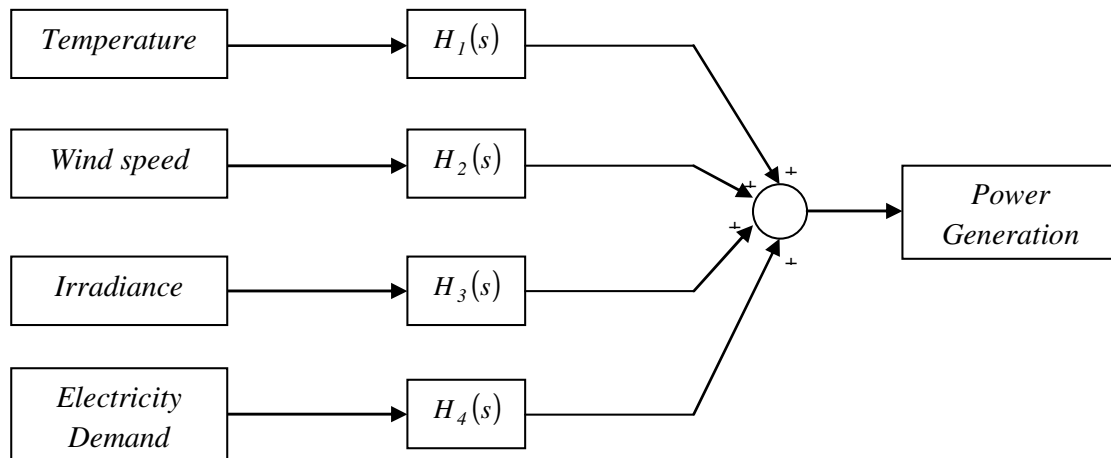

Figure 1: Block diagram of the modeled dynamic system

In order to identify the transfer functions for each input variable, the matrices coefficients describing the system, as in (1), had to be determined first, starting from the data sets built as described previously.

$$\begin{cases} \dot{x} = A \cdot x + B \cdot u \\ y = C \cdot x + D \cdot u \\ x|_{t=t_0} = x_0 \end{cases} \quad (1)$$

where  $x \in R_+$  is the state vector,  $u \in R^4$  represents the vector containing the inputs,  $y \in R_+$  is the output and  $A \in R$ ,  $B \in R^4$ ,  $C \in R$ ,  $D \in R^4$  are the coefficient matrices (here, vectors). Regarding the dependence between sizes of the aforementioned vectors it is stated that:

$$\begin{aligned} \dim(A) &= \dim(x) \times \dim(x) = 1 \\ \dim(B) &= \dim(x) \times \dim(u) = 1 \times 4 \\ \dim(C) &= \dim(y) \times \dim(x) = 1 \\ \dim(D) &= \dim(y) \times \dim(u) = 1 \times 4 \end{aligned}$$

The inputs vector  $\dim(u) = 4 \times 1$  has the following elements:

$$u = \begin{bmatrix} \text{Temperature} \\ \text{WindSpeed} \\ \text{Irradiance} \\ \text{ElectricityDemand} \end{bmatrix}$$

Given the discrete nature of the state vector, first order derivative in time was calculated as the difference between every two consecutive records. To determine the four coefficient matrices having an only two equations system, we made the following suppositions:

- *case 1*

$A = C = [1]$  and vectors  $B$  and  $D$  resulted as:

$$\begin{aligned} B &= \frac{(\dot{x} - x) \cdot u^T}{\|u\|^2} \\ D &= \frac{(y - x) \cdot u^T}{\|u\|^2} \end{aligned}$$

Average values of their elements, used to identify the dynamic system:

$$\begin{aligned} B &= [-0.001617 \quad -0.002439 \quad -0.000279 \quad -0.0011452] \\ D &= [0.029926 \quad 0.040917 \quad 0.0053946 \quad 0.022673] \end{aligned}$$

The transfer function corresponding to each input, as illustrated in Figure 1:

$$\begin{aligned} H_1(s) &= \frac{0.02993 \cdot s - 0.03154}{s - 1} \\ H_2(s) &= \frac{0.04092 \cdot s - 0.04336}{s - 1} \end{aligned}$$

$$H_3(s) = \frac{0.005395 \cdot s - 0.005674}{s - 1}$$

$$H_4(s) = \frac{0.02267 \cdot s - 0.02382}{s - 1}$$

- case 2

$B = D = [1 \ 1 \ 1 \ 1]$  and vectors  $A$  and  $C$  resulted as:

$$A = \frac{\dot{x} - B \cdot u}{x}$$

$$C = \frac{y - D \cdot u}{x}$$

Average values of their elements, used in identifying the dynamic system:

$$A = [-3165.5692]$$

$$C = [-3148.7371]$$

The transfer functions corresponding to each input are the same:

$$H_1(s) = H_2(s) = H_3(s) = H_4(s) = \frac{s + 16.83}{s + 3166}$$

### 2.3. Results discussions

According to the previous section, in the hypothesis of Case 1, the system is naturally unstable, having a positive real part of the pole ( $s=1+j0$ ). However, in Case 2, with all the inputs having the same transfer function to the output, the system is stable, even failing control.

Whereas we have used a linear representation of the system in open loop, both Bode and Nyquist plots can be employed to address its frequency response and stability.

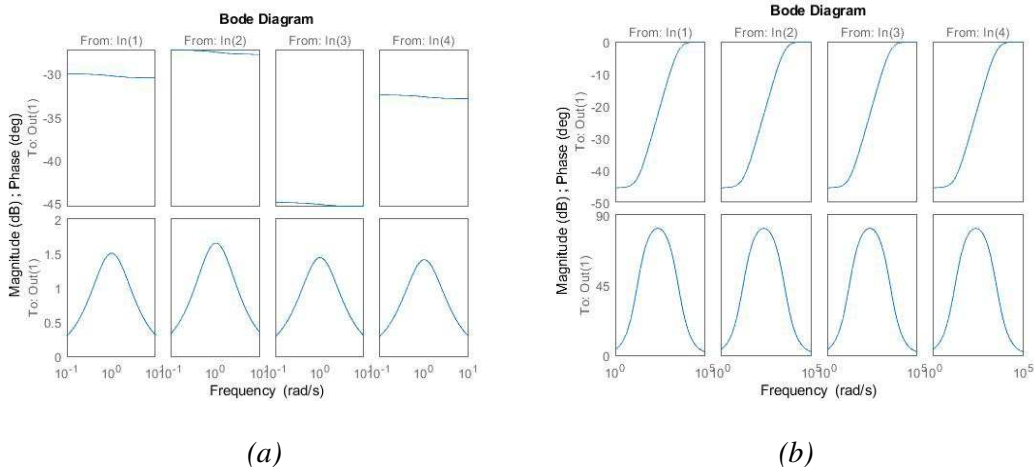
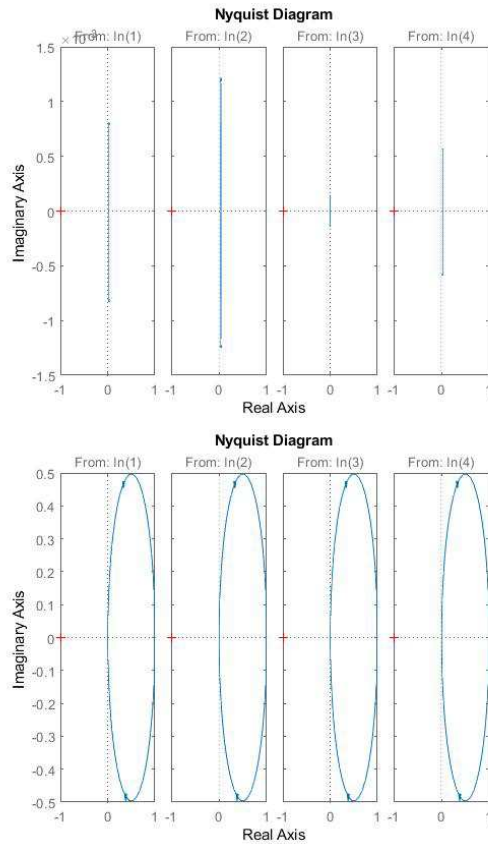

Figure 2: Frequency response (a) case 1; (b) case 2

As shown in Figure 2, even if transfer functions in case 1 are particular for each input, the differences in terms of frequency response are small, both for magnitude and phase. The

output is delayed with  $(25 \div 45)^\circ$ , constantly almost the entire frequency range; the magnitude of the output is amplified up to  $\sim 1.22$  (1.75 dB) times for the second input around the frequency of 1 rad/s (0.159 Hz). With respect to the frequency response of the system in Case 2, it can be noticed that the phase delay decreases with frequency, reaching zero near  $10^5$  rad/s ( $\sim 16$  kHz); the amplification of the input goes far up to  $10^4$  ( $\sim 80$  dB).



(a)

(b)

Figure 3: Nyquist plot (a) case 1; (b) case 2

Figure 3 pictures the Nyquist plots for the two cases, in neither of the two the graph encircling the critical point.

### 3. CONCLUSIONS

The dynamics of energy systems are very complex and given the variability of renewable energy sources, with an increasing share in meeting electricity demand, assessment of their unsteady behavior is critically important. This paper addresses a state space modeling of such systems and analyses simulation results lacking control, to evaluate their natural response. According to the results presented, the model system is stable in some hypothesis; we shall consider in further research implementing additional control in order to improve their evolutionary course.

## ACKNOWLEDGMENT

This work was supported by a grant of the Romanian Ministry of Research and Innovation, CCCDI – UEFISCDI, project number PN-III-P1-1.2-PCCDI-2017-0404 / 31PCCDI/2018 and 37BMPNIII-P3-199/2016-I05.16.01, within PNCDI III.

## References

- [1] Ahmed, N.A., Miyatake, M., Othman, A.K., *Power fluctuations suppression of stand-alone hybrid generation combining solar photovoltaic/wind turbine and fuel cell systems*, Energy Conversion and Management, Vol. 49, 2008
- [2] Feuerriegel, S., Neumann, D., *Measuring the financial impact of demand response for electricity retailers*, Energy Policy, Vol. 65, 2014
- [3] Gils, H.C., *Assessment of the theoretical demand response potential in Europe*, Energy, Vol. 67, 2014
- [4] Veit, A., Goebel, C., Tidke, R., Doblender, C., Jacobsen, H.A., *Household Electricity Demand Forecasting – Benchmarking State-of-the-Art Methods*, ACM e-Energy 2014, 5<sup>th</sup> International Conference of Future Energy Systems
- [5] Singh, A.K., Ibraheem, K.S., Muazzam, M., *An Overview of Electricity Demand Forecasting Techniques*, 2013 National Conference on Emerging Trends in Electrical, Instrumentation & Communication Engineering
- [6] [www.transelectrica.ro](http://www.transelectrica.ro)
- [7] Harvey, A., Koopman, S.J., *Forecasting Hourly Electricity Demand Using Time-Varying Splines*, Journal of the American Statistical Association, Vol. 88, 1993
- [8] De Felice, M., Catalano, F., Alessandri, A., *Seasonal climate forecasts for medium-term electricity demand forecasting*, Applied Energy, Vol. 137, 2015

# **SIMULATION OF A SMALL SCALE RENEWABLE ENERGY SYSTEM**

Dana-Alexandra Ciupăgeanu, Gheorghe Lăzăroiu, Ana Micu  
University Politehnica of Bucharest

## **ABSTRACT**

Energy generation from renewable energy sources has exceeded even the most optimistic expectations. Among the most widespread technologies, wind energy and photovoltaic involve many stochastic related issues. Fuel cells proved to be a promising solution towards mitigating these problems. This paper aims to analyze the behavior of a small scale hybrid energy system consisting of a 12.9 kW photovoltaic array as generating unit, a 6 kW proton exchange membrane fuel cell as storage device and a load. The simulations were performed using Matlab/Simulink environment, representing the components using Simscape/SimPowerSystems blocks. Steady and dynamic behavior of the hybrid system was thus observed, the interaction between the fuel cell and the PV array being analyzed in terms of power output variation.

## **1. INTRODUCTION**

The variability of renewable energy sources generation gives rise to significant problems having system-wide implications. Mitigating their inherent intermittency caused by the natural dependence on weather conditions is, therefore, an extremely important goal in order to achieve both increasing renewables share in the global energy mix and adequate levels of reliability of supply [1], [2].

Integration of energy storage systems together with renewable power plants, as photovoltaic (PV) or wind energy for instance, can overcome the previously mentioned difficulties. Such hybrid systems, capable of accumulating the production exceeding demand at a certain point and use it to supply the load in energy shortage conditions, improves power quality [3]. Among available storage technologies, choosing the one best fitting a particular application must consider several technical and economical factors to ensure optimal overall performance of the installation [4].

Compared with other alternatives, hydrogen energy storage shows promising advantages in terms of ease of installation and reduced losses. Moreover, it has a low environmental impact, which represents a very attractive feature in the context of increasingly restrictive environmental policies worldwide [3].

Exploiting each renewable energy source by itself generates unacceptable power output fluctuations from consumers' perspective. Employing instead hybrid systems, it is possible to efficiently operate each integrated resource, according to its particularities, prevailing individual limitations and enhancing global yield [1-3].

Correlated with society progress, energy demand increases; given that fossil fuel depletion is a stringent concern, research naturally focused past decades on renewable energy sources [2].

The role of fuel cells, converting chemical energy directly to electrical energy, is to compensate the power fluctuation of the renewable source, within the hybrid system [5]. The reliability of fuel cells is a major asset, among available technologies Proton Exchange Membrane Fuel Cell (PEMFC) standing out as very suitable for small scale application. High investment costs caused by Platinum electrodes and the necessity of pure Hydrogen as fuel are still a drawback [6], [7].



Table 1 presents the general characteristics of fuel cells, providing the limits of their variation ranges. Among the applications of PEMFC in power systems, we must mention back up power and small distributed generation [8].

Table 1: General characteristics of fuel cells [8]

Quantity	Measurement unit	Value
Energy density	$Wh/dm^3$	500 ÷ 3000
Power density	$W/dm^3$	≈ 500
Specific energy	$Wh/kg$	150 ÷ 10000
Specific power	$W/kg$	5 ÷ 800
Power rating	$MW$	≤ 60
Rated energy capacity	$MWh$	≤ 0.312
Daily self discharge	%	≈ 0
Lifetime	<i>years</i>	5 ÷ 20
Cycling times	<i>cycles</i>	1000 ÷ 20000
Discharge efficiency	%	59
Cycle efficiency	%	20 ÷ 66
Response time	<i>s</i>	≤ 5 · 10 <sup>-3</sup>
Suitable storage duration	Medium to long (hours ÷ months)	
Discharge time at power rating	Seconds to hours	
Power capital cost	$$/kW$	500 ÷ 3000

Given the advantages previously presented of exploiting renewable energy power plants, such as PV systems, in hybrid architectures alongside storage technologies, namely PEMFC, this paper presents a simulation model for estimating the responses characteristics of such a system in several particular scenarios of interest.

## 2. METHODOLOGY

### 2.1. Simulation model

The simulation model is represented using Simulink/Simscape PowerSystems blocks and includes:

- i. a 12.9 kW<sub>p</sub> PV array, consisting of ten parallel strings of six 215 W<sub>p</sub> modules each. The voltage at its terminals reaches the maximum value of  $V_{max} = 217.8V$ , in open circuit, and  $V_{MPP} = 174V$  at the maximum power point.
- ii. a 6 kW PEMFC, having a voltage output of  $V_{PEMFC} = 45V$ . The flow rate was considered as varying signal for control purposes.
- iii. a generic DC load.
- iv. the DC bus, modeled as a generic capacitive bus.
- v. the power electronics interface connecting the generating subsystem to the load, comprising two boost converters (for the connection of the PV array and PEMFC to the DC bus).
- vi. the low-pass filters.
- vii. the measurement sensors.
- viii. the control subsystem, grasping the converters control and the power flow management within the hybrid system.

Figure 1 pictures the block diagram of the simulation model, which does not comprise the electrolyzer providing the fuel to the PEMFC. Here we consider solely the interaction between the PV array, the PEMFC and the load, as a standalone system.

The irradiance input for the PV array was set according to statistical data available regarding average insolation in Bucharest, Romania [9].

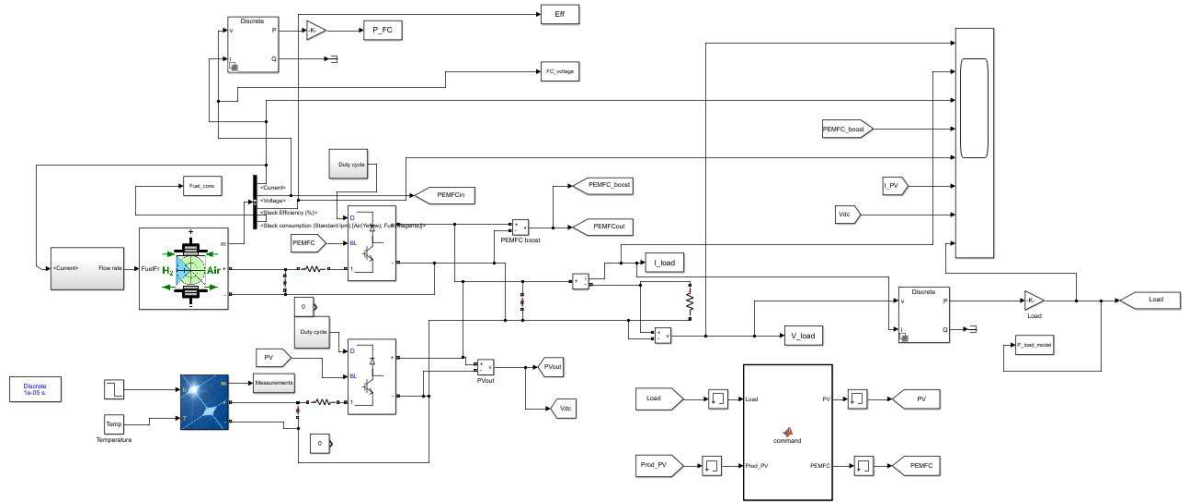

Figure 1: Overall structure of the system

## 2.2. Control algorithms

Considering the continuous variability of the irradiance, a control algorithm ensuring the maximum power yield at the terminals of the PV array must be implemented. In this configuration, an algorithm relying on incremental conductance principle was employed; for better response, a variable duty cycle reference and integral component were used. Algorithm's parameters resulted from simulation in open circuit and at nominal load.

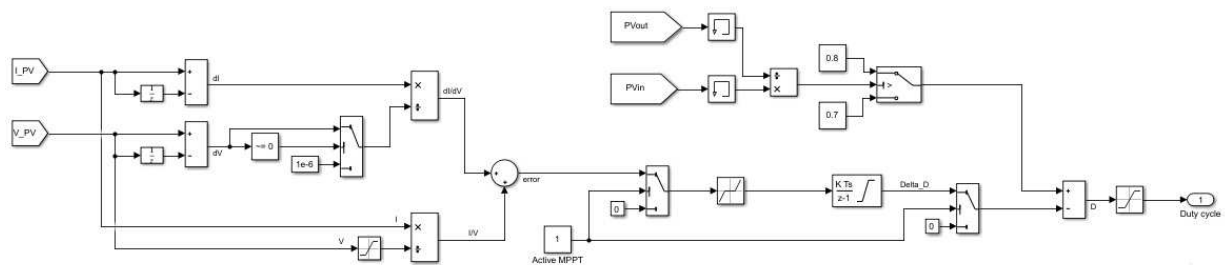

Figure 2: MPPT algorithm block diagram

The flow rate regulator purpose is to adjust fuel flow, based on a current input signal, in order to obtain a constant output. In this regard, the nominal Hydrogen utilization was of 99%, with 99.5% pure H<sub>2</sub> composition and 1.5 bar pressure. The fuel cell operates at 65 °C. The regulator, illustrated in Figure 3, establishes the flow according to (1):

$$\dot{Q} = 2.551 \cdot 10^{-9} \frac{T \cdot n_c \cdot \dot{a}}{f \cdot c \cdot p} \quad (1)$$

where  $T [K]$  is cell's temperature,  $n_c [-]$  is the number of cells,  $a [L/s]$  is the air flow,  $f [-]$  is the nominal utilization of  $H_2$  (the fuel),  $c [-]$  is its composition and  $p [bar]$  represents fuel pressure.

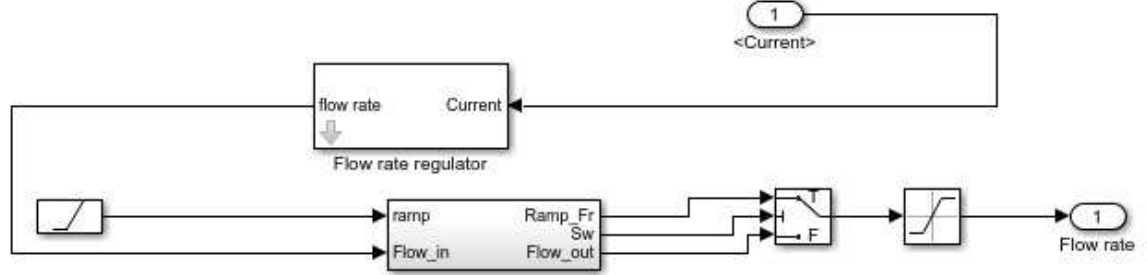

Figure 3: Flow rate regulator

The boost converter connecting the fuel cell to the DC bus has a variable duty cycle reference, depending on the quote between the FC voltage output and the DC bus measured voltage.

The general control logic, here implemented through the Matlab function in Figure 1, is based on the principle that the FC supplies to the load any power shortage due to irradiance variation. PV generation exceeding the demand at any time is used by the electrolyzer, not represented in this model.

### 2.3. Simulation scenarios framework

In order to picture the circumstances when the FC has to provide the load, which we have considered to be constant during simulation time span ( $t_s=5$  s), the difference between the PV generation and the current demand, we simulated following scenarios:

- the irradiance is constant and equal to the minimum average, according to Table 2:

$$I = 398 \text{ W/m}^2 \rightarrow P_{PV} = 4.8 \text{ kW}$$

- the irradiance changes suddenly at  $t=1.5$  s, dropping with 0.5 p.u.

$$I = \begin{cases} I_1 = 398 \text{ W/m}^2 \rightarrow P_{PV}^1 = 4.8 \text{ kW} \\ I_2 = 199 \text{ W/m}^2 \rightarrow P_{PV}^2 = 2.4 \text{ kW} \end{cases}$$

- the irradiance changes suddenly at  $t=1.5$  s, increasing with 0.5 p.u.

$$I = \begin{cases} I_1 = 398 \text{ W/m}^2 \rightarrow P_{PV}^1 = 4.8 \text{ kW} \\ I_2 = 597 \text{ W/m}^2 \rightarrow P_{PV}^2 = 7.2 \text{ kW} \end{cases}$$

Table 2: Monthly irradiance [9]

Month	Maximum average daily irradiance [W/m <sup>2</sup> ]
January	432
February	586
March	786
April	931
May	978
June	995
July	957
August	904
September	816
October	658
November	460
December	398

#### 2.4. Simulation results

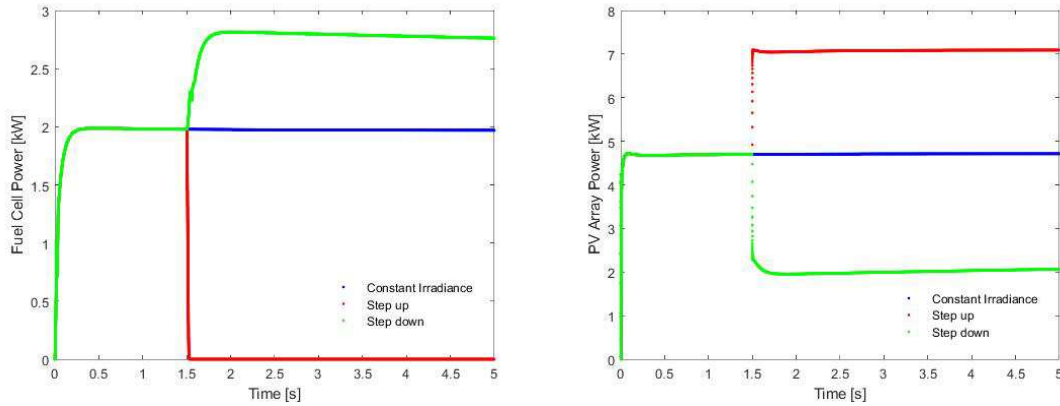

Figure 4: (a) FC power output; (b) PV array power output

As shown in Figure 4, the power output at the terminals of the FC compensates the variation of PV array production in order to meet the demand. It can be noticed that the transient time is very short, the dynamic response stabilizing fast.

### 3. CONCLUSIONS

Storage technologies integrated in hybrid architectures with renewable energy sources mitigate their power fluctuations, improving the quality and reliability of the supply. PEMFC has showed a good dynamic performance compensating output variability of PV arrays consequently irradiance intermittency.

#### Acknowledgment

This work was supported by a grant of the Romanian Ministry of Research and Innovation, CCCDI – UEFISCDI, project number PN-III-P1-1.2-PCCDI-2017-0404 / 31PCCDI/2018 and 37BMPNIII-P3-199/2016-I05.16.01, within PNCDI III.

## References

- [1] Ahmed, N.A., Miyatake, M., Othman, A.K., *Power fluctuations suppression of stand-alone hybrid generation combining solar photovoltaic/wind turbine and fuel cell systems*, Energy Conversion and Management, Vol. 49, 2008
- [2] Huang, P.H., Kuo, J.K., Wu, Z.D., *Applying small wind turbines and a photovoltaic system to facilitate electrolysis hydrogen production*, International Journal of Hydrogen Energy, Vol. 41, 2016
- [3] Agbossou, K., Kolhe, M., Hamelin, J., Bose, T.K., *Performance of a Stand-Alone Renewable Energy System Based on Energy Storage as Hydrogen*, IEEE Transactions on Energy Conversion, Vol. 19, 2004
- [4] Eskander, M.N., El-Shater, T.F., El-Hagry, M.T., *Energy flow and management of a hybrid wind/PV/fuel cell generation system*, Energy Conversion and Management, Vol. 47, 2006
- [5] Desideri, U., Lazaroiu, G., Zaninelli, D., Lazaroiu, C., *A Matlab-Simulink Analysis of Hybrid SOFC Dynamic Behavior*, 3rd International Conference on Fuel Cell Science, Engineering and Technology, Ypsilanti, Michigan, USA, 23-25 May, 2005
- [6] Wang, C., Nehrir, M.H., *Power Management of a Stand-Alone Wind/Photovoltaic/Fuel Cell Energy System*, IEEE Transaction on Energy Conversion, Vol. 23, 2008
- [7] Onar, O.C., Uzunoglu, M., Alam, M.S., *Modeling, control and simulation of an autonomous wind turbine/photovoltaic/fuel cell/ultra-capacitor hybrid power system*, Journal of Power Sources, Vol. 185, 2008
- [8] Luo, X., Wang, J., Dooner, M., Clarke, J., *Overview of current development in electrical energy storage technologies and the application potential in power system operation*, Applied Energy, No. 137, 2015
- [9] <http://re.jrc.ec.europa.eu>

# NANOSTRUCTURED MATERIALS FOR ENERGY VALORISATION OF USED OILS

Mihai Dragne, Ionel Pișă\*, Cristina Covaliu, Gheorghe Lazaroiu

*\*University Politehnica of Bucharest, Romania, ionel.pisa@upb.ro*

## ABSTRACT

One of the most important issues of today's society is the decontamination of soil, water and atmosphere. The paper proposed the development of advanced, integrated technologies for advanced materials with properties of nanostructured adsorbents, ions changeable and catalytically from raw natural zeolites (minerals) and hydrotalcite type compounds and the use of these materials in processes of waste oil recovery with remediation effect and energy recovery.

## 1. INTRODUCTION

One of the most important issues of today's society is the decontamination of soil, water and atmosphere. The paper proposed the development of advanced, integrated technologies for advanced materials with properties of nanostructured adsorbents, ions changeable and catalytically from raw natural zeolites (minerals) and hydrotalcite type compounds and the use of these materials in processes of waste oil recovery with remediation effect and energy recovery.

After 1990, the quantity of waste oils collected for regeneration in Romania dropped by almost 20 times, up – at the end of 2000 to less than 1000 tones, although the national park by motor vehicles has increased (are currently 4,800,000 registered cars), the number of eating fast food and big stores virtually exploded, the remaining quantity of waste oils, in particular in the industry, dropping slightly. The quantities of waste oils forgone are a major source of pollution to soil and water. This situation is because users have been able to procure the necessary lubricants from Romanian or foreign firms – which we have never pretended to surrender used oil-then – situation that remains today.

One of the directions of the research is to obtain advanced materials for the purification activity through modulating capacities of adsorption, ion exchange and catalysis of hydrotalcite type compounds and clinoptilolite (available as local natural resource), using different pretreatment techniques in order to obtain material with predetermined properties (tailored) selective for different pollutants. The technology of advanced materials preparation must allow the recovery of oils so as a friendly working environment methodology.

The another research area is oriented to the use of advanced materials obtained in the cleaning of waste oils coming from different sources, in order to achieve the objectives set by national and international standards to ensure the conservation and sustainable management of resources at the same time ensuring low costs and energy consumption.

Currently the technology of purification of waste oils used as changeable, anions and cations on the basis of organic resins synthesis involves the appearance of highly toxic waste. These types of changeable replacement of ions with minerals (cations) and hydrotalcite (anions, which can be obtained by the methods of synthesis of relatively inexpensive and less polluting or even from natural sources such as hydrotalcites deposits) leads to lower the risk of environmental contamination by the ion exchangers technology. In this project, it will try to eliminate traces of transitional metals (Ni, Pb, Cd, Cu, Zn, Cr) and organic pollutants (phenols and phenolic

compounds; benzene and its derivations, colorants, etc) by coupling the processes of adsorption and ion exchange (process with low energy consumption, environmental friendly processes) using as adsorbents/ion exchanger advanced materials obtained by modifying the properties of natural zeolites clinoptilolite type and hydrotalcite type [16].The final research area aims to capitalize on used advanced materials in remediation processes for decreasing the amount of waste, in compliance with the basic principles of environmentally friendly processes. For this purpose, it will examine the possibility of using advanced materials used (due to the retention of metallic ions by adsorption/ion exchange), by using them as catalysts for remediation of contaminated gaseous streams or even use the natural component with adsorbed metallic ions as addition in basic material for highways construction.

## 2. ADSORBENT MATERIALS

Minerals of the group structure of the stratified natural clays, such as montmorillonit and bentonite represents attractive adsorbing materials due to low price and wide spreading area. Compared with active coal, bentonite can be a more economical adsorbent for the treatment of waste water of textile industry. The nature of the porous structure and chemical properties are decisive for the adsorption ability of bentonite. The hydrophilic properties induced by metal cations that can be substituted with other cations by ion exchange are not favorable for organic compounds adsorption. Published studies show possibility of improving adsorption capacity by the application of some treatments to modify the surface properties of bentonite. Depending on the chemical composition, bentonite clays are grouped in bentonite sodium (Na-BENT) and bentonite calcium (Ca-BENT). Bentonite clay with higher montmorillonit content has advantageous properties for adsorption [1].

Adsorption ability of bentonite can be improved through modifications with organic compounds involving the impregnation of organic molecules on the surface. The process of with an organic compound by impregnation is achieved through replacement of inorganic cations ( $\text{Na}^+$ ,  $\text{K}^+$ ,  $\text{Ca}^{2+}$ ,  $\text{Al}^{3+}$ ) with organic cations, mostly with quaternary ammonium cations ( $\text{R}_4\text{N}^+$ ). Organic functional groups interaction with hydroxyl surface groups has the effect of changing the hydrophilic character of bentonite and getting a natural material with hydrophobic or organophilic properties [3], [4]. At the same time, the capacity of the bentonite adsorption for certain pollutants can be improved by treatment with inorganic acids ( $\text{HCl}$  or  $\text{H}_2\text{SO}_4$ ) at high temperatures. The application of such acidic activation process must be managed with caution taking into account the possible effects of alteration of the structure, chemical composition and physical properties of bentonite (Figures 1 and 2) [2].

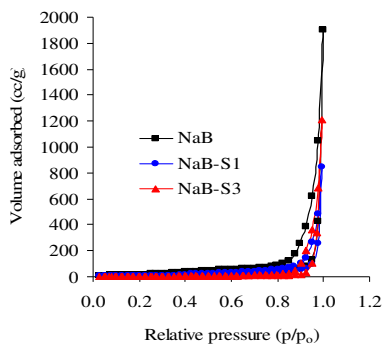

*Fig.1. Adsorption/desorption isotherms*

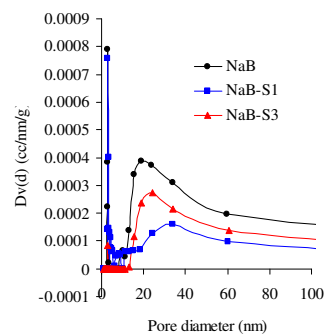

*Fig.2. Pores distribution curves in bentonite samples*

In Table 1 are presented the characteristics of bentonite coming from Romanian mineral deposits [2]. Notice that the bentonite highbrow Gurasada has a very low Fe<sub>2</sub>O<sub>3</sub> content (0,53-1,69%). Compared to other deposits, bentonite Gurasada contains a less quantity of clay minerals (64-88%). Montmorillonit is the main mineral in bentonite Gurasada composites [5], [6].

Table 1: *The chemical characteristics of the bentonites in Romania*

Chemical composition (% wt)	Bentonite coming from Romanian mineral deposits			
	Valea Chioarului	Petresti	<b>Gurasada</b>	Orasul Nou
SiO <sub>2</sub>	66,11-77	70-74	<b>70.40-72.99</b>	60.62-71.46
Al <sub>2</sub> O <sub>3</sub>	10,94-16,09	12.5-13.5	<b>12.60-14.65</b>	15.40-23.55
Fe <sub>2</sub> O <sub>3</sub>	1.60-2.08	1.15	<b>0.53-1.69</b>	0.84-2.34
CaO	1.01-2.10	2	<b>1.60-2.73</b>	1.18-1.86
MgO	1.10-2.22	2.7	<b>2.62-3.69</b>	0.54-2.05
Na <sub>2</sub> O	0.55-1.60	0.6	<b>0.00-1.11</b>	0-0.3
K <sub>2</sub> O	0.00-1.35	1.5	<b>0.0-1.0</b>	0.25-2.16
TiO <sub>2</sub>	0.50-0.62			
MnO	0.03-0.05			
P.C		5.9	<b>6.29-9.69</b>	8.69-12.4

### 3. USED OIL REGENERATION TECHNOLOGIES

There are many technologies in the world for regenerating used oils. Basically, they are based on the principles of vacuum distillation, chemical treatments and thermal treatments. There are some (most advanced) technologies with the advantages and disadvantages of each.

In **Mohawk** technology (vacuum distillation) the used oil is chemically pretreated to avoid precipitation of contaminants which can cause corrosion and fouling of the equipment. The distillate is hydropurified at high temperature and pressure in the presence of catalytic bed. The technology is applied in North Vancouver, California, Indonesia and Australia.

In **Blowdec** technology (cracking/separation) the process is based on separation of hydrocarbons from the waste oil in a hot whirling bed created by solid particles (hot sand) in a reactor. Simultaneously with the separation, visbreaking process of hydrocarbons occurs. In Markušovce, Slovak Republic is applied.

In **Dunwell WFE** technology (wipe film evaporation) the used oil from collectors is separated from water and solid particles by centrifuging, then heated to temperature around 150 °C and sent to a flash evaporator for removing water and light hydrocarbons. The technology is applied in Yuen Long Industrial Estate, Hong Kong.

In **Prop** technology (chemical treatment/distillation/clay treatment/hydrofinishing) the used oil is treated by water solution of diammonium phosphate for separation of metals and ash-forming components. For this purpose, preheating mixture of used oil and treating agent is sent to contractor where water solution salt is dispersed into the oil. Metallic phosphates formed in the chemical reaction are removed by filtration. Some plants were built, but now they are not in operation because of financial difficulties.

**The technology proposed** is aimed for the process of revitalization of residual oils (from different sourcing) by contacting them semi-dynamic, with natural/modifies nanostructured compounds. Under these conditions for the recycling of waste oils in the laboratory facility is proposed in Figure 3. In principle, the process consists in residual oil recirculation, stashed in the vessel 1, after a preliminary filtration through the filter hopper 2 (which will retain mechanical impurity), with the help of the centrifugal pump 3 in the adsorber vessel 4. Recirculation of the



residual oil through the centrifugal distributor 6, seeks an intimate contact between the liquid phase (residual oil) and solid phase (nanostructured adsorbent), introduced in the adsorber 4 through a spilling system 7. Revitalized oil is stored, after filtration through the filter hopper 2' (for retention of solid adsorbent material) in the revitalized oil tank 5.

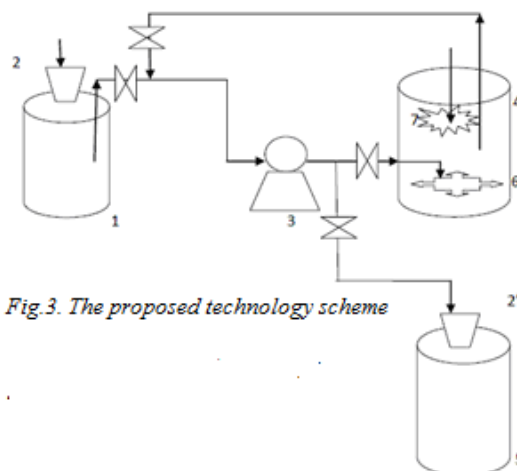

Fig.3. The proposed technology scheme

#### 4. CONCLUSIONS

- The novelty of this paper is the implementation in practice of innovative technologies simple and accessible to obtain modified nanostructured materials used in treating a wide range of waste oils.
- This technology contributes to international research efforts to develop synthesis technologies for zeolite materials. The complexity of the proposed solutions is high, involving on one hand the use of techniques for obtaining modified nanostructured materials and to characterize the systems of revitalizing waste oils, and, on the other hand, implementation in practice of a flexible technology that can be operated easily under certain conditions imposed by the dynamics of the process and the quality of raw materials.
- This process is more cost-effective than the conventional method of treatment as the raw material is easy to find, the technology is simple and very effective.

„This work was supported by a grant of the Romanian Ministry of Research and Innovation, CCCDI – UEFISCDI, project number **PN-III-P1-1.2-PCCDI-2017-0404 / 31PCCDI/2018**, and project number **37BMPNIII-P3-199/2016-I05.16.01**, within **PNCDI III**”

#### References

1. **C. Orha, A. Pop, C. Lazau, I. Grozescu, V.Tiponut, F. Manea**, *Structural characterization and the sorption properties of the natural and synthetic zeolite*, Journal of optoelectronics and advanced materials, Vol. 13, No. 5 , 544 –549, IF = 0.457
2. **Dr.hab.Vasile RUSU**, *ADSORBANȚI MINERALI NATURALI*. PROSPECTIUNI, Akademos-Chimie, nr.3 (18), septembrie 2010, 101-104
3. **Udonne J. D** , *A comparative study of recycling of used lubrication Oils using distillation, acid and activated charcoal with clay methods*, Department of Chemical and Polymer Engineering, Lagos State University, Lagos, Nigeria, J.Petroleum Gas Eng.
4. **Naveed Anwar, Syed Shahid Ali, s.a.**, *Recycling of Automotive Lubricating Waste Oil and Its Quality Assessment for Environment-Friendly Use* Res. J. Environ. Earth Sci., 912-916, 2012
5. **R.Ganea, N.Natu, C.Marinescu, I.R.Tamas, I.Popescu, Gr.Pop**, *Catalizator perfectionat pe baza de nanomateriale pentru indepartarea noxelor din instalatiile de emailare*, A00889/2011 (12.09.2011).
6. **Tetisan I.**, *Studii si cercetari privind utilizarea tufurilor zeolitice din zona Bârsana în tehnologii neconventionale de epurare a apelor uzate*, teza de doctorat, Cluj-Napoca, 2010

# VELOCITY DISTRIBUTION IN SIMULATED EXHALE AIR FLOW, WITH VIRTUAL BREATHING THERMAL MANIKINS

Ivanov M.<sup>1</sup>, Mijorski S.<sup>2</sup>

<sup>1</sup>Senior Assist. Professor, PhD, Technical University of Sofia, FPEPM, Department:  
"Hydroaerodynamics and Hydraulic Machines", Sofia 1000, Bulgaria

<sup>2</sup>PhD, SoftSim Consult Ltd., Consultant at Technical University of Sofia, FPEPM,  
Department: "Hydroaerodynamics and Hydraulic Machines", Sofia 1000, Bulgaria

## ABSTRACT

The presented paper illustrates a CFD based study on the velocity distribution in simulated exhale air, by two different types of virtual breathing thermal manikins. The used manikins differ mainly in their shape. The first one represents physiologically identified female body, with high degree of geometrical accuracy. The second manikin is constructed by simplified polygonal shapes, designed to match the overall 95<sup>th</sup> percentile of the anthropometric size of a standard person. A performance comparison between the two manikin models is made, by velocity distribution analyses in the simulated exhale air. Also, different steady state and transient modelling techniques (RANS, URANS, DES, and LES) are implemented and compared. The numerical results showed in general a good correlation with the reality, and high degree of similarity, between the different flow patterns. However, there is a tendency for over-prediction of the manikins' thermal plume impact over the exhaled air flows in the steady state numerical results.

## 1. INTRODUCTION

Producing experimental studies with real Thermal Manikins (TMs) is literally cost and time consuming, and may require highly skilled labour (*Madsen, 1999*). It is explained by the fact that TMs are modern, expensive and complex tools for measurement and analyses of the convective flows around human bodies in different conditions, without excessive risk of human exposure (*Nilsson, 2006; Bjørn, 1999*). They are used for assessment of the human thermal comfort, as well as for analyses of the indoor air quality in the occupied spaces. In terms of functionality, TMs are not just used for simulation of different levels of physical activity (through surface heat losses), but also for simulating other human actions such as breathing, sweating, sneezing, coughing and others.

Consequently, the use of Virtual Thermal Manikins (VTMs) appears to be an appropriate alternative to the actual manikins' experiments, especially at the design stage of the indoor environment (*Ivanov, 2015*). Recent studies indicate sufficient advances in this area. For example, the study of *Villafruela et.al. (2016)* summarizes that in the last years, Computational Fluid Dynamics (CFD) simulation tools have been used to study the diffusion of inhaled and exhaled contaminants from different ambient environments. Also, complex airborne infection routes have been studied with CFD, including the sneezing and coughing mechanisms (*Villafruela et.al., 2016*).

But still, a need exists for rather inexpensive and easy to construct and use real TMs, especially when numerical models have to be verified and validated with experimental measurement data. Therefore, the authors have previously proposed a simplified polygonal construction of TM with breathing function (*Ivanov and Mijorski, 2017-2*), which would

---

<sup>1</sup>Sofia 1000, Bulgaria, "Kliment Ohridski" Blvd. #8, Technical University – Sofia, +359898240221, [m\\_ivanov@tu-sofia.bg](mailto:m_ivanov@tu-sofia.bg)

present an opportunity for manikin's production cost and experiment maintenance optimizations. However, a numerical performance analysis of the developed model is required, in order to confirm its accuracy and feasibility at this design stage.

Therefore, the objective of the presented study is to examine the geometrical characteristics' impact over the velocity distribution in the modelled exhalation flow, with the previously developed breathing thermal manikins – the physiologically identical one (called *Humanoid Manikin*) and the proposed simplified shape one (called *Polygonal Manikin*). The differences or the similarities in the velocity fields between the two shapes will provide initial assessment measure for the both models performance. Also, different steady state and transient modelling techniques and boundary conditions have to be implemented and compared, due to the fact that the breathing process in humans is highly transient and the breathing flow parameters are changing completely and rapidly in relatively short period of time.

## 2. 3D GEOMETRY SET-UP

The presented *Humanoid Manikin* is multifaceted, 3D female manikin, specially remodelled and adapted for the purpose of the study. It represents with high degree of physiological identity a real female human, has an approximate surface area of  $1.8 \text{ m}^2$ , and height of 1.65 m. The nasal valve opening was built according to the study of *Lin (2015)* and was initially used by the authors in *Ivanov and Mijorski (2017)*. The nasal opening area is  $7.3 \times 10^{-5} \text{ m}^2$ , as shown on Fig.1. The normal to the nasal opening was specified to 45 degrees from the vertical body axis. Furthermore, exhaust walls from the nasal valve to the nose end were inclined to 15 degrees according to *Nilsson (2006)* and *Lin (2015)*. The *Humanoid Manikin* is used only in the cases with steady state modelling conditions.

The *Polygonal Manikin* represents the overall 95<sup>th</sup> percentile of the anthropometric size of a standard person. It is constructed to meet the basic requirements of the ergonomic design area. It has an approximate surface area of  $2 \text{ m}^2$  and height of 1.75 m. The nasal valve opening is constructed in the same way as in the base model, described above. This polygonal manikin is proposed for use in real research applications, as well as for educational purposes, complying with the requirements for: high degree of manufacturability; high degree of mobility; availability in different scales and open design. For the purpose of the study, the *Polygonal Manikin* is used in simulations with steady state modelling conditions, as well as in the cases with transient modelling conditions.

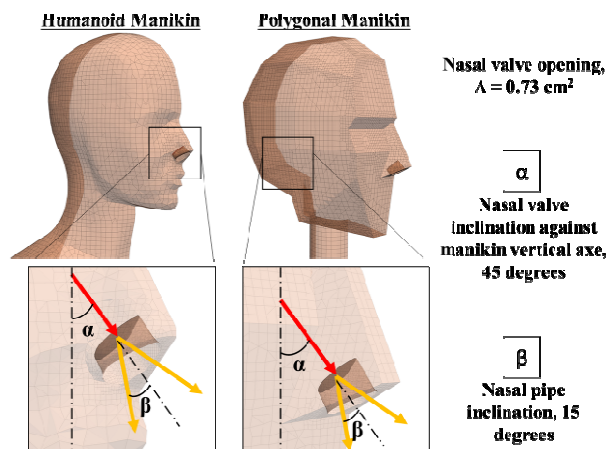

Figure 1: 3D models and nasal valve geometry details

### 3. NUMERICAL MODEL SET-UP AND BOUNDARY CONDITIOS

#### 3.1. STEADY STATE MODELLING CONDITIONS

For the cases with steady state modelling conditions, the 3D models of the virtual thermal manikins were placed inside rectangular shaped room with dimensions: 3 m height, 4 m width and 4 m depth, with introduced symmetry plane through the centre of the room, thus having only one nasal valve opening in the domain. The spatial discretization was completed with snappyHexMesh utility, part of an HELYX® ([www.engys.com](http://www.engys.com)) software package, which provides an enhanced version of the CFD code OpenFoam® ([www.openfoam.com](http://www.openfoam.com)).

In all numerical grids was followed one and the same meshing logic, i.e. defining base cell size to  $4 \cdot 10^{-2}$  m and increasing the refinement level to  $6.25 \cdot 10^{-4}$  m in the nasal valve zone, in order to capture the detailed geometrical features. Also, the numerical models were well refined at the surfaces of the manikins, with a first layer height of approximately  $0.5 \cdot 10^{-3}$  m. These refinements were dictated from the requirement for low  $y^+$  values over the manikin surfaces, recommended in the work of *Spalart (2001)*. The total number of computational cells used is 1139195 for the *Humanoid Manikin*, and 1417722 cells for the *Polygonal Manikin*.

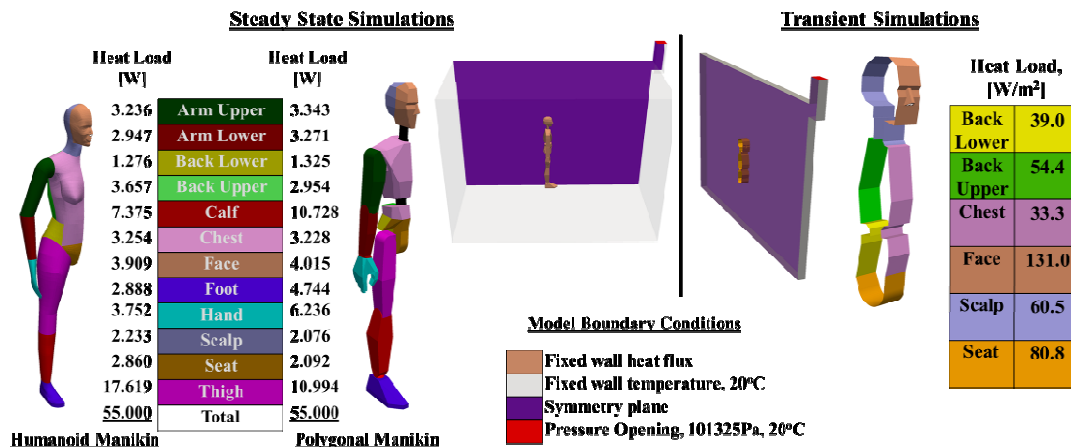

Figure 2: Model set-up and boundary conditions for the steady state and for the transient simulations

In total of six Reynolds-Averaged Navier–Stokes (RANS) CFD simulations were performed, three for each individual virtual manikin. The three phases of the human breathing cycle were simulated, including: inhaling, exhaling and no breathing (the free convection flow case). The implemented solver for all simulations was *buoyantBoussinesqSimpleFoam*. This solver models a buoyant turbulent flow of incompressible fluids with combinations of Semi-Implicit Method for Pressure-Linked Equations (SIMPLE) algorithms. The turbulent features of the resulted buoyant flows were modelled with introduction of the Shear Stress Transport (SST)  $k-\omega$  turbulence model suggested by *Menter (1993)*. This model is based on a two-equation eddy-viscosity approach, where the SST model formulation combines the use of a  $k-\omega$  in the inner parts of the boundary layer, but also switches to a  $k-\epsilon$  behavior in the free-stream regions of the solutions. In the work of *Menter (2011)* are provided further details of the selected turbulence model.

The buoyant flows were modelled with the same material properties for the air. These were derived for reference conditions of 101325 Pa for the pressure and 20 °C for the air temperature. Thus the air density was specified to  $1.204 \text{ kg/m}^3$ , the dynamic viscosity to  $1.82 \cdot 10^{-5} \text{ kg/(m s)}$ , kinematic viscosity to  $1.51 \cdot 10^{-5} \text{ m}^2/\text{s}$ , and specific heat to  $1006.0 \text{ J/(kg}\cdot\text{K)}$ .

Details regarding the adopted boundary conditions in the CFD simulations are provided in Fig.2. The heat fluxes specified for the manikins' surfaces were derived from the study of Nilsson (2006). These were calculated for total heat load of 110 W from the whole manikin surface. The velocity inlet for the exhale phase and outlet for the inhale were specified at the nasal valve openings. The approximated flow rates for one nasal valve ( $6.29 \cdot 10^{-4} \text{ m}^3/\text{s}$  for the inlet flow rate and  $6.91 \cdot 10^{-4} \text{ m}^3/\text{s}$  for the outlet flow rate) were calculating based on the study of Lin (2015). The turbulent intensity for the nasal velocity inlet was approximated to 6.8 % by Reynolds number calculation with proposed by Lin (2015).

### 3.2. TRANSIENT MODELLING CONDITIONS

For the cases with the transient modelling conditions, the computational domain was significantly reduced by introducing two symmetry planes, at the both sides of the manikin. This measure was considered with clear understanding of the flow restrictions that will be introduced, but with an aim of simulation time reduction. As shown in Fig. 2, the model comprised just 0.1 m section of the manikin, including the two nasal valve openings, head and manikin body, excluding the hands and legs.

The base cell size was defined to  $2.5 \cdot 10^{-2} \text{ m}$  and to capture the nasal valve zones geometrical features the maximum level of cells refinement reached to  $8.0 \cdot 10^{-4} \text{ m}$ . Additionally the manikin's surfaces were refined with the introduction of prism layers. By first layer height of  $0.4 \cdot 10^{-4} \text{ m}$ , the  $y+$  values over manikin surfaces were below 4 as recommended in the work of Spalart (2001). Thus, the models matched the basic requirements of LES method for resolving accurately the turbulent flow over object surfaces.

Three unsteady/transient 3D simulations were performed, covering two different phases of the human breathing cycle. These included no breathing or the free convection flow case for time duration of 20 seconds (allowing to get the solutions to a fully developed convective flow around the manikin and room space) and sequentially 2 seconds of exhale phase. In order to keep maximum Courant number below 1, the simulations were run with different time steps, as for former case it was set to  $\Delta t = 1.0 \cdot 10^{-3}$  seconds, while for the latter it was reduced to  $\Delta t = 0.25 \cdot 10^{-3}$  seconds.

The solver for the transient buoyant turbulent flow of incompressible fluids `buoyantBoussinesqPimpleFoam` is used with combinations of PIMPLE algorithm for pressure-linking. The PIMPLE represents a merged Semi-Implicit Method for Pressure-Linked Equations (SIMPLE) and Pressure Implicit with Splitting of Operator (PISO) algorithms, thus offering an improved solution and faster convergence for the transient solutions.

The Unsteady Reynolds-Averaged Navier–Stokes (URANS) simulations were run with the Shear Stress Transport (SST)  $k-\omega$  turbulence model initially proposed by Menter (1993). For the Detached Eddies Simulations (DES), the Spalart-Allmaras turbulent model was implemented. Initially, the standard Spalart-Allmaras model was proposed by Spalart and Allmaras (1994), and then its DES formulation was proposed by Shur et al. (1999). The model uses the distance to the closest wall as the definition for the length scale, which plays a major role in determining the level of production and destruction of turbulent viscosity of the flow.

And finally, the Large Eddies Simulations (LES) were run with  $k$ -equation eddy viscosity Sub-Grid-Scale (SGS) model formulation. The model is well described in the work of Chai and Mahesh (2012). The one-equation eddy viscosity model for large-eddy simulation has an additional transport equation for SGS kinetic energy.

## 4. CFD RESULTS

For the purpose of the comparative study, the numerical results are presented by velocity iso-line contours only for the exhalation phase, at a section on the symmetry plane of the manikin models, for the steady state simulations (see Fig. 3), while for the unsteady transient models, at the centre of the computational domain (see Fig. 4). In both cases, this is a plane through the centre of the manikins' nose.

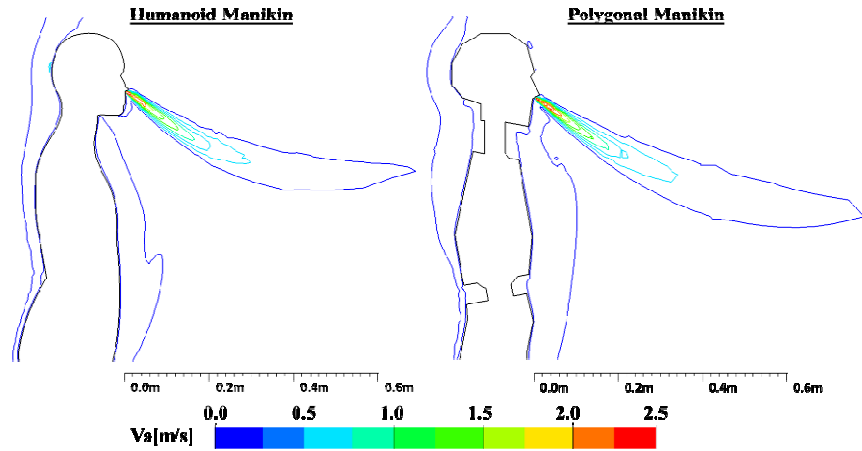

Figure 3: Velocity iso-lines for the steady state simulations

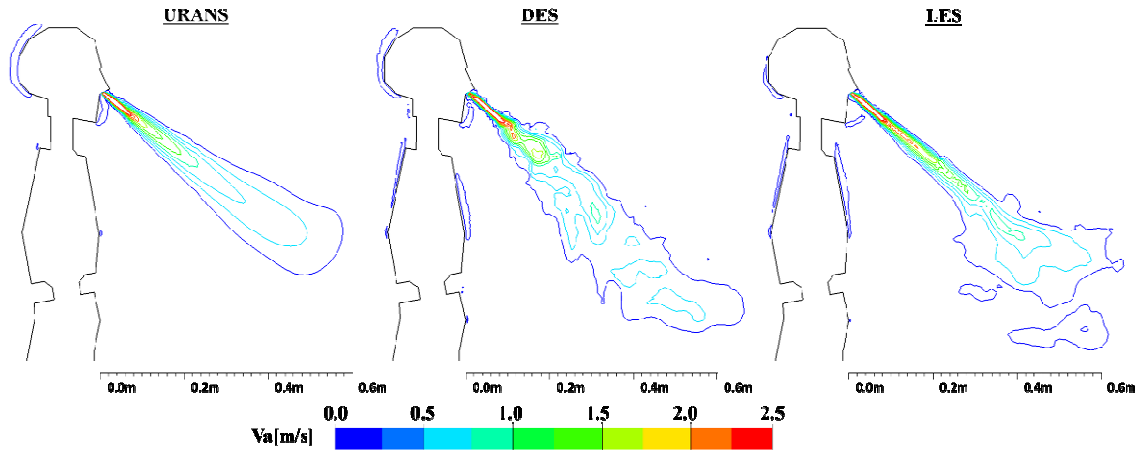

Figure 4: Velocity iso-lines for the transient simulations

## 5. DISCUSSION AND CONCLUSIONS

A CFD based study of the exhalation flow velocity distribution is performed, under steady state and transient conditions. The analyses of the results assisted the understanding of the implications caused by the geometrical characteristics of the presented manikin models, as well as the different numerical methods and implemented boundary conditions in the CFD simulations. However, the comparative analyses between smooth surface manikin and polygonal with many sharp edges and openings by itself is a difficult task. The *Humanoid Manikin* model would be characterized with more laminar flow along the surfaces, while the polygonal with more turbulent flow and mixing at the upper zones of the model. That fact would explain the achieved differences in the resulting velocity patterns.

It is considered that the steady state models may over-predict the manikins' thermal plume impact over the exhaled air flows in the breathing zone, as suggested by the results. Implementing transient conditions further improve the presented model and give a more accurate representation and a possibility for a more accurate prediction of the dynamic processes in the VTM's breathing zone.

The comparison analysis has shown better correlation between DES and LES simulation results for the modelled exhalation phase in the breathing zone away of the nasal openings. However, the implementation of this two more advanced CFD techniques requires significantly higher computational resources compared to URANS. Also, these two methods are sensible to selection of boundary conditions, such as symmetry planes, which can alter the modelled flow by restricting large eddies generation. Nevertheless, URANS simulations have demonstrated good results in the breathing zone for the exhale phase with slight underprediction of the air velocity.

### Acknowledgements

The presented study is supported by "RDS" at TU-Sofia, as part of the activities under the "Perspective leaders" project, with Contract № 181ПП0005-02, entitled: "Experimental comparison of the air jet characteristics during exhalation, with numerical results from developed virtual breathing thermal manikin".

### References

- [1] Bjørn E., *Simulation of human respiration with breathing thermal manikins*, Proceedings of the 3rd international meeting on thermal manikin testing 3IMM, Stockholm, Sweden, 12–13 October, 1999.
- [2] Chai X., Mahesh K., "Dynamic k-equation model for large-eddy simulation of compressible flows", *Journal of Fluid Mechanics*, vol. 699, pp. 385-413, 2012;
- [3] Ivanov M., *Compact Breathing Simulation System, Developed as Additional Functionality for Thermal Manikins*, "Romanian Journal of Building Services", Vol.1, No.3, ISSN: 2393-5154, pp. 1-12, 2015.
- [4] Ivanov M., Mijorski S., *CFD modelling of flow interaction in the breathing zone of a virtual thermal manikin*, "Energy Procedia" Journal, Volume 112, pp. 240-251, ISSN: 1876-6102, Elsevier, 2017.
- [5] Ivanov M., Mijorski S., „*Geometrical characteristics' impact over the thermal plume modelling with breathing thermal manikins*“, 15th International Conference on Environmental Science and Technology, ISSN 1106-5516, Manuscript ID: cest2017\_00414, Rhodes, Greece, 31 August to 2 September 2017 - 2.
- [6] Lin S., *Nasal Aerodynamics*, Chief Editor: Arlen D Meyers, MD, MBA, <http://emedicine.medscape.com/article/874822-overview#a1>, Updated: May 14, 2015.
- [7] Madsen T., *Development of a breathing thermal manikin*, Proceedings of the 3<sup>rd</sup> international meeting on thermal manikin testing 3IMM, Stockholm, Sweden, 12–13 October, 1999.
- [8] Menter F., *Zonal Two Equation k- $\omega$  Turbulence Models for Aerodynamic Flows*, AIAA Paper 93, 1993.
- [9] Menter F., *Turbulence Modelling for Engineering Flows*, ANSYS Inc., 2011.
- [10] Mijorski S, Ivanov M., „*Comparison of different CFD techniques for transient modelling of virtual breathing thermal manikins*“, 15th International Conference on Environmental Science and Technology, ISSN 1106-5516, Manuscript ID: cest2017\_00415, Rhodes, Greece, 31 August to 2 September 2017;
- [11] Nilsson H., *How to Build and Use a Virtual Thermal Manikin Based on Real Manikin Methods*, *Sixth International Thermal Manikin and Modelling Meeting*, "Thermal Manikins and Modelling", ISBN: 962-367-534-8, 2006;
- [12] Shur M., Spalart P., Strelets M., Travin A, "*Detached-Eddy Simulation of an Airfoil at High Angle of Attack*", 4th International Symposium on Engineering Turbulence Modeling and Experiments, Corsica, France, 1999);
- [13] Spalart P. and Allmaras S., "*A One-Equation Turbulence Model for Aerodynamic Flows*," *Recherche Aerospaciale*, No. 1, pp. 5-21, 1994;
- [14] Spalart P., *Young-person's guide to detached-eddy simulations grids*, NASA/CR-2001-21103, Boeing Commercial Airplanes, Seattle, Washington, 2001;
- [15] Villafruela J., Olmedo I., San Jose J., "Influence of human breathing modes on airborne cross infection risk", *Building and Environment* 106, pp. 340-351, 2016.

# **HOLISTIC OF RENEWABLE ENERGY SOURCES IMPACT AND SOLUTIONS FOR INTERCONNECTION TO THE POWER SYSTEM**

Gheorghe LAZAROIU<sup>1</sup>, Cornel PANAIT<sup>2</sup>, Lucian MIHAESCU<sup>1</sup>, Mihai TIRSU<sup>3</sup>,

Virgilius DUMBRAVA<sup>1</sup>, Gabriel NEGREANU<sup>1</sup>, Ionel PISA<sup>1</sup>

<sup>1</sup>)Universitatea POLITEHNICA Bucuresti, <sup>2</sup>)Universitatea Maritima Constanta,

<sup>3</sup>)Academia de Științe a Moldovei

## **ABSTRACT**

This paper disseminates the research project, of wide impact, regarding HOLISTICS OF THE RENEWABLE ENERGY SOURCES ON ENVIRONMENT AND CLIMATE - HORESEC is to develop new instruments, methods, models, and technologies. These ones, based on evaluating the increase of share of renewable energy sources in the energy production and dynamics of the ratio between thermal and electrical energy, will lead to minimize the costs and maximize the efficiency. The project will present solutions tested on a pilot installation for adapting the renewable energy sources system to the dynamics of renewable energy share increase in the total energy production, including through long-term storage solutions. The HORESEC improvement of institutional capacity facilitates delivering high quality research services and, in the same time, increases the visibility at national and international level by disseminating the results.

## **1. INTRODUCTION**

The present paper deals with the project HOLISTICS OF THE RENEWABLE ENERGY SOURCES ON ENVIRONMENT AND CLIMATE – HORESEC, in agreement with framework P1 of the plan PNIII, subprogram 1.2. This project deals with improvement of institutional performances of four universities (University Maritime of Constanta, University Stefan cel Mare of Suceava, University POLITEHNICA of Bucharest, Technical University of Cluj-Napoca), two national research-development institutes (National Institute for Research and Development in Electrochemistry and Condensed Matter – INCEMC Timisoara, National Institute for Research and Development in Electrical Engineering ICPE-CA Bucharest) and an institute of Romanian Academy (Geography institute). The partners are covering a wide national area, through 5 development regions (S-E, Bucharest-Ilfov, N-E, West, Center).

The HORESEC project supports smart specialization in energy domain through a holistic analysis of the impacts of energy sources on climate change and meeting both the objectives of sustainable development and advanced and progressive knowledge. The increased integrating process of renewable energy sources (RESs) has been driven by a rapid reduction of the exploitation costs of these technologies.

Increasing the share of RES complicates the functioning of current systems requiring new long-term storage measures and solutions, developed in the HORESEC project. These solutions will be tested on a pilot plant to adapt the system to the growth dynamics of renewable energy share in energy production, including long-term storage solutions.

The main objectives are:

---

<sup>1</sup>glazarioiu@yahoo.com



- Establishing the main climatological and environmental parameters with impact on RES and vice versa;
- The realization of the mathematical model of the evolution of the analyzed factors, identifying the climatological, environmental and social indicators associated with the RES dynamics, which will be subsequently verified on the developed pilot installation;
- Efficiency of energy production through new technologies and algorithms to optimize the RES response, developing new methods and measurement models;
- Use of biomass in an integrated stream with hydrogen production and storage and methanisation, and sustainable reduction of CO<sub>2</sub> emissions [1-3];
- Finding innovative storage solutions on medium and long term;
- Demonstration of the project feasibility by experimental determinations on a pilot plant, facilitating the takeover of the research results by the industrial environment.

## 2. METHODOLOGY

The work-plan of the five projects is in agreement with the specific objectives of the general project, carried out in stages, from concept development to functional model verification, and until the validation of the experimental model, both on individual components and on the pilot plant. The main components of the project are described in the following.

### ***1. The influence of the increasing of the renewable energy sources share on the environment and climate evolution.***

The aim is to establish the main climatological and environmental parameters with impact on renewable sources and vice versa. An analysis of the environmental impact factors associated with the exploitation of renewable energy sources at regional level for a sustainable development of the energy sector is being pursued in line with "Directive 2009/28/CE" which establishes that by 2020 the power produced from renewable energy sources to represent 20% of power consumed in the EU and 10% of power consumed in the transport sector.

The energy potential approach will be integrated, taking into account all renewable energy sources in the study area. The territorial variation of direct solar radiation is very high, depending on the relief forms and the dominant direction of air circulation. The distribution of the average wind speed on the Romanian territory highlights that the main area with high wind energy potential is that of the mountain peaks where the wind speed can exceed 8 m/s. Also, the geographic zoning of Romania's micro-hydro-potential indicates higher values in the mountain area.

The energy production is dependent on the variation of the climatic parameters with energy potential, the tendency for them to evolve before and after the infrastructure installation of the exploitation/efficient use of the renewable energy sources is evaluated. Thus, the level of energy autonomy must be maintained regardless the climatic variations at regional level.

A database will be created to present the average values and the trend of these parameters, both before and after the installation of new renewable sources. By realizing the mathematical model of the evolution of the analyzed factors, we will identify climatological, environmental and social indicators associated with the RES dynamics, which will be subsequently verified locally and on the developed pilot plant.

### ***2. The adaptation of photovoltaic and wind sources to the dynamics of renewable energy increase in total energy production.***

The proposed objective is to make this energy more efficient through new technologies and optimization algorithms for RES response. The energetics based on renewable energy sources (RES) is the cheapest and most affordable way to reduce polluting gases emissions to the production of heat and electricity with the help solar, wind and biomass. Each of these technologies has found a development niche and the field in which they can have a high yield, being able to compete with known technologies of obtaining energy from fossil fuels. Wind energy is expected to take up a significant share of the energy produced by nuclear power plants and fossil fuel plants.

The use of renewable energy sources has a significant impact on the national power system, requiring studies on the take-up of power produced by wind turbines, micro-hydropower and cogeneration using biomass in the future transport and distribution network as smart grids, and also the construction of new power generation units with high operating flexibility in order to counteract and/or limit negative effects.

According to Romania's energy strategy for 2007-2020, the annual theoretical potential of the main renewable energy sources is: Thermal solar energy -  $60 \times 10^6$  GJ, Photovoltaic energy - 1.2 TWh, Wind energy - 23 TWh, Biomass -  $318 \times 10^6$  GJ. The usable potential of these sources is much lower due to technological limitations, economic efficiency and environmental restrictions. The disadvantages that have slowed down the large-scale implementation of RES, namely the fact that the energy produced is dispersed which determines a high cost of the final energy production facilities, the uneven distribution over time, and especially the lack of storage and of energy reserves.

New measurement methods and models will be developed and also suitable monitoring sensors for the main electrical measures. New topological network structures, efficient solar and biomass conversion solutions and new models of energy conversion generators, respectively efficient storage and use of renewable energy will be developed.

Expansion of storage systems at an energy system level as well as for the electric cars supply still requires important milestones, especially for increasing the energy density and the number of charging/discharging cycles. Energy, by its nature, can affect sustainability both through pollution and contributing to the depletion of resources. Energy innovation can contribute to the rational use of energy without reducing the quality of life, quality of goods and products developed over time.

### ***3. Dynamics of the ratio between thermal and electrical energy produced from biomass.***

In order to analyze the future possibilities of including biomass in the national RES balance, a country database will be developed, especially for agricultural biomass and secondary forestry biomass [4-7]. By mapping the biomass resources in the country, a database of national interest will be created which will allow correlation with the national primary balance of energy fuels.

Bio-energy fuels of the future will also be established and the possibilities of blending with other categories of fuels will be analyzed [8]. A comparative energy analysis will be carried out for the potential of agricultural biofuels and those derived from biomass. Particular attention will be paid to the complex modeling of combustion, experimental combustion tests in boilers and diesel engines with the analyzed biofuels categories will be made. The feasible combustion technologies will be defined for the analyzed biofuels categories.

The utilization of biomass will be achieved in an integrated stream with the production and storage of methane hydrogen and finally a sustainable reduction of CO<sub>2</sub> emissions.

Analysis of the dynamics of the ratio between the thermal and the electric energy will allow the economic direction of biofuels towards the two energy flows, depending on the territorial resources as a whole, economic transport opportunities, socio-economic requirements. The analysis will be completed with data regarding the human potential of national agricultural and forestry areas, potential that influence the development of energy production and use in the territory.

In the overall development of the project, the efficient combustion of biofuels will represent a use of the hydrogen flux ( $H_2$ ) that is produced from other renewable resources such as wind, solar, thus resulting a holistic integration in the overall design of the project. The hydrogen from the production and storage stream developed by wind and solar energy sources will be used not only for combustion of biofuels but for diesel engines as well as for methanisation. Obtaining methane gas  $CH_4$  from hydrogen and carbon dioxide achieves maximum environmental protection with the complete closure of the holistic concept regarding the use of renewable energy resources for the energy-environment-climate trinom.

#### ***4. Evolution of long-term storage solutions for environmentally sustainable energy.***

Increasing the share of RES has the effect of transforming the energy system so that it can absorb the production variations of the diverse RES components and implicitly to find medium and long term storage solutions. The new electrolysis and methanisation technologies presented in Fig. 1 are producing hydrogen and methane, which can then also be used to produce energy [9]. These technologies are in the research and testing phase and the project will make an important contribution to its development, including innovative decarbonisation technologies.

Research into catalytic methanisation processes involves two options: the use of CO or  $CO_2$  as raw material. CO methanisation is an exothermic process in which raw materials - CO and  $H_2$  - are used to produce  $CH_4$  and  $H_2O$ ; the use of  $CO_2$  with  $H_2$  is also an exothermic process. If the used  $H_2$  comes from electrolytic sources, the  $CO_2$  methanisation allows the transformation of electrical energy into chemical energy (the Power-to-gas process). Established methanisation processes include: fixed bed adiabatic methanisation, fixed bed methanisation, fluidized bed methanisation, three-phase methanisation.

Catalytic methanisation takes place at temperatures above  $250\text{ }^\circ\text{C}$ . The chosen type of catalyst is influencing the design of the reactor used in the process, and its activity and selectivity are very important in the process. Especially metals from groups 8-10 fixed to a suitable substrate  $Al_2O_3$ ,  $SiO_2$  and  $TiO_2$  are used.

One of the possible variants is biological methanisation with methanogenic microorganisms. This process involves the conversion of  $H_2$  and  $CO_2$  to methane through a reaction that is similar to that proposed by Sebatier. Biological methanisation is an alternative to metallic catalytic thermal methanisation. Studies on biological methanisation cover a wide range of experimental conditions and conclusions. These differ depending on the method, the operating parameters and the raw material used.

Another possibility to obtain SNG is the photocatalytic reduction of  $CO_2$ , the methane formation yields are much lower than the ones in the case of natural photosynthesis or photocatalytic generation of  $H_2$ . The interest in this research field has grown heavily in recent years, as is shown by the growing number of published works. The heterogeneous photocatalytic reduction of  $CO_2$  cannot yet be implemented in practice. The electrochemical reduction of  $CO_2$  with the formation of hydrocarbons and alcohols is another variant that would allow the conversion of renewable energy sources into fuels and chemicals.

If  $CO_2$  can be electrochemically reduced to hydrocarbons then any of the renewable electricity sources can be used for this and a very large step towards storing the energy of

these intermittent resources will be made. We will study the possibilities of using the methanisation reactors, the reaction conditions (temperature, pressure) and the catalysts in order to obtain a higher efficiency for methanisation and finally to realize a functional prototype model of a methanizer within the INCEMC Timisoara.

**5. Transformations of the energy system by maximizing the energy production from renewable sources - verification based on a pilot plant.**

The scientific and technical novelties of the project are represented by the design of the pilot plant in order to maximize the energy production in the energy system. At the same time, the pilot plant will be the experimental model in which measurements and experimental determinations will be carried out for the calibration of the theoretical models.

The essential goal is to demonstrate the feasibility of the project through experimental determinations on a pilot installation, disseminating the obtained results towards industrial environment. Following the stages of the knowledge process, procedures and methods are applied using the descriptive and inferential statistical analysis of data that is taken directly from the network.

In order to make the right and opportune decision regarding the maximization of energy production in the energy system, an analysis must be made on the technical state basis and on the equipment importance within it for the defined purpose. Measurements, experimental determinations and program development are carried out.

Initially we determine the state of the parameters and the possibilities for monitoring the electrical equipments in order to know the technical condition, and function of the economic sustainability, the possible architectures can be designed. Depending on the time gap and transmission capacity, the experimental model is decided. Then a modular, adaptable and heterogeneous communication system is implemented using TCP, UDP, IEC 61850 protocols.

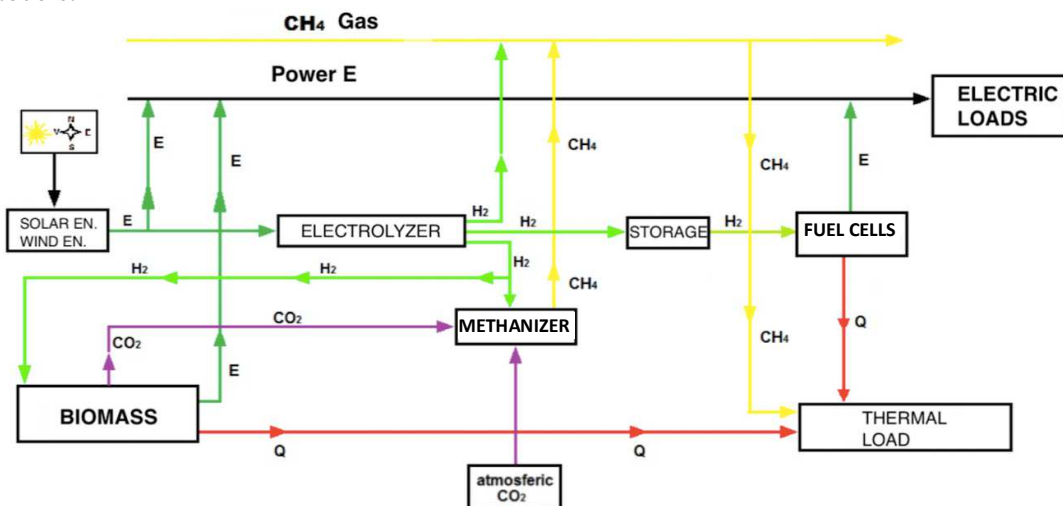

Figure 1: HORESEC Configuration

**3. CONCLUSIONS**

The scientific novelty of the project is represented by the identification of the energy production methods from renewable and verifiable energy sources by realizing the experimental pilot installation. The RES generation system is a complete and secure system including sustainable high-efficiency renewable sources, power storage and energy storage devices that can provide an energy-efficient architecture.

Validation on a pilot plant of the original model proposed, the Energy System regarding Power Maximization, represents the core and essence of the objectives and results of the HORESEC project. The proposed storage and testing solutions will increase the maneuverability of the system, proportionate and concomitant with the share and efficiency of renewable energy sources, which can function to the maximum extent permitted by environmental and climate factors. The project includes biomass and thermal-photovoltaic regenerative hybrid solar systems in a total electrical and thermal energy balance, and assesses the impact of renewable energy on the environment and climate.

HORESEC objectives have an indirect and international impact on interconnections between Member States or between their energy networks. Considering the high level of the produced energy control energy and the medium and long term storage capabilities, the project achievements will contribute to smooth the load profile and implicitly to the cost reduction.

The HORESEC project proposes a viable solution to achieve the EU's medium and long-term objective of integrating a large proportion of renewable energy, in particular by using variable energy sources that can be viable up to 90% in a stable and safe state.

Through the knowledge transfer made under the HORESEC project, a number of companies with the headquarters in EU will be able to offer on the market competitive products and services for the next 5 years - 10 years after the end of the project. A number of physical products will be developed, and a number of algorithms and methods will be developed and combined to provide new services. The non-academic partners of the consortium can further develop these services to reach the market level within 5-10 years, as most of them will reach the TRL5 or TRL6 phases according to the application/implementation plan of each project.

The project presents a holistic approach to the interaction of energy with the environment and the climate as well as a multidisciplinary one, so the project improves the concept of innovation.

## **ACKNOWLEDGMENT**

„This work was supported by a grant of the Romanian Ministry of Research and Innovation, CCCDI – UEFISCDI, project number PN-III-P1-1.2-PCCDI-2017-0404 / 31PCCDI/2018 and 37BMPNIII-P3-199/2016-I05.16.01, within PNCDI III”.

## **References**

- [1] Innovative Energy Vector Hydrogen-Solid Biomass, PN-II-ID-PCE-2011-3-0698, Framework IDEI 2011, Grant IDEI-2011 no. 30/05.10.2011.
- [2] Lazaroiu, G., Pop, E., Negreanu, G., Pisa, I., Mihaescu, L., Bondrea, A., & Berbec, V. (2017). Biomass combustion with hydrogen injection for energy applications. *Energy*, 127, 351–357
- [3] Pisa I., Lazaroiu G., Prisecaru T. (2014). Influence of Hydrogen Enriched Gas Injection upon Polluting Emissions from Pulverized Coal Combustion. *International Journal of Hydrogen Energy*, 39, 17702–17709
- [4] Non-Polluting Technology for energy generation through intensified combustion in suspension/pulverized of sawdust – TAISRUG, Grant no. 22103/01.10.2008, CNMP Partnerships.
- [5] Lazaroiu G., Oprea I., Mihaescu L., Prisecaru T., Pisa I., Negreanu G., Mocanu C.R.(2012). Biomass Briquettes From Pitcoal-Wood: Boiler Test Facility Combustion Case Study. *Journal of Environmental Protection and Ecology*, 13, 1070-1081
- [6] Alternative technologies to replace gaseous fuels through sustainable combined use of forestry and coal resources – TAIGUDREFOC, Grant no. 187, CEEX 2006
- [7] Lazaroiu G., Mihaescu L., Pisa I., Pop E., Negreanu G., Berbec V. (2014). Hydrogen - An Energy Vector In Efficient Combustion of Energy Willow. 49th International Universities Power Engineering Conference (UPEC), Cluj-Napoca, Romania
- [8] Lazaroiu, G., Pană, C., Mihaescu, L., Cernat, A., Negurescu, N., Mocanu, R., & Negreanu, G. (2017). Solutions for energy recovery of animal waste from leather industry. *Energy Conversion and Management*, 149, 1085–1095
- [9] Integrated energy module of 5kW based on fuel cells – Mener-5, Grant no. 21-034/18.09.2007.

# BODIES SHAPE INFLUENCE ON THE EFFECTS PRODUCED IN LIQUID ENVIRONMENTS

Lucian MÂNDREA<sup>1</sup>, Corina Alice BĂBUȚANU<sup>2</sup>, Cristian CONSTANTINESCU<sup>3</sup>

<sup>1</sup>Politehnica University of Bucharest,

Splaiul Independenței nr.313, sector 6, Bucharest, Romania

<sup>2</sup>National Institute for Research and Development in Electrical Engineering ICPE-CA,

Splaiul Unirii nr.313, sector 3, Bucharest, Romania

<sup>3</sup>Deo Design

## ABSTRACT

The authors used three types of bodies which were rotated inside a vessel with water. The effects produced by each device were determined, using experiments. Conclusions about the practical utilization of each object for industrial use were obtained. The first one was a Rushton turbine, the second one a propeller with two blades and the third a body like a flying saucer. Each one has a different effect in a rotating fluid. The momentum and the power consumption were determined. Conclusions about how useful every type of object can be were drawn.

## 1. INTRODUCTION

According to the different necessities of a variety of industrial processes, different types of objects can be used to move fluids. Three objects with three different effects were used by the authors. The Rushton turbine and the two blades propeller can be used in mixing reactors. They create different types of mixing flows. The third object, like a flying saucer, is supposed to influence less the mixing process. Different types of impellers were used by the authors to study mixing processes before [1]. Aspects of mixing processes could be seen in articles published by other authors [2, 3, 4, 5, 6, 7]. The flying saucer can be used, instead, to warm the fluid from the inside.

One of the effects of an impeller rotation is the increase of the fluid temperature. A tangential shear stress between the fluid layers leads to energy loss as heat.

We can calculate the total amount of energy transformed into heat by rotating a disk with the diameter  $D$  in a cylinder as follows [1].

The disk placed at the distance  $h_1$  from the superior part of a cylinder and at the distance  $h_2$  from the bottom of the cylinder rotates in the water with the density  $\rho$  and the dynamic viscosity  $\mu$ .

If the rotating speed of the disk is  $n$ , the angular speed is  $\omega$  and the tangential speed is  $v$  in a laminar flow, then the shear stress is given by the Newton law:

$$\tau = \mu \frac{v}{h} = \mu \frac{\omega r}{h} \quad (1)$$

The momentum as  $\tau S v$  and, then, the total power lost in the cylinder can be obtained [1]:

---

<sup>1</sup>Barlea 26, Bucharest, +40728098421, [mandrea\\_lucian@hotmail.com](mailto:mandrea_lucian@hotmail.com), lucian.mandrea@upb.ro

$$P = \frac{\pi}{160} (\zeta_1 + \zeta_2) \rho \omega^3 D^5 \quad (2)$$

With the value of this power, the total amount of heat produced in a certain time can be calculated.

## 2. METHODOLOGY

Three sets of experimental measurements were carried out in an experimental plant presented in [1]. The experimental setup used is shown in Figure 1. It consists of a transparent cylindrical vessel with the ratio  $D/H$  of about 1.5 and a capacity of  $0.126 \text{ m}^3$ . It is equipped with a variable speed motor on whose shaft bodies of different types and sizes can be fitted.

It has an electronic speed control and a panel which displays the rotational speed and the momentum produced by the bodies studied. Tap water was used under atmospheric pressure at a temperature of  $20^\circ \text{ C}$ .

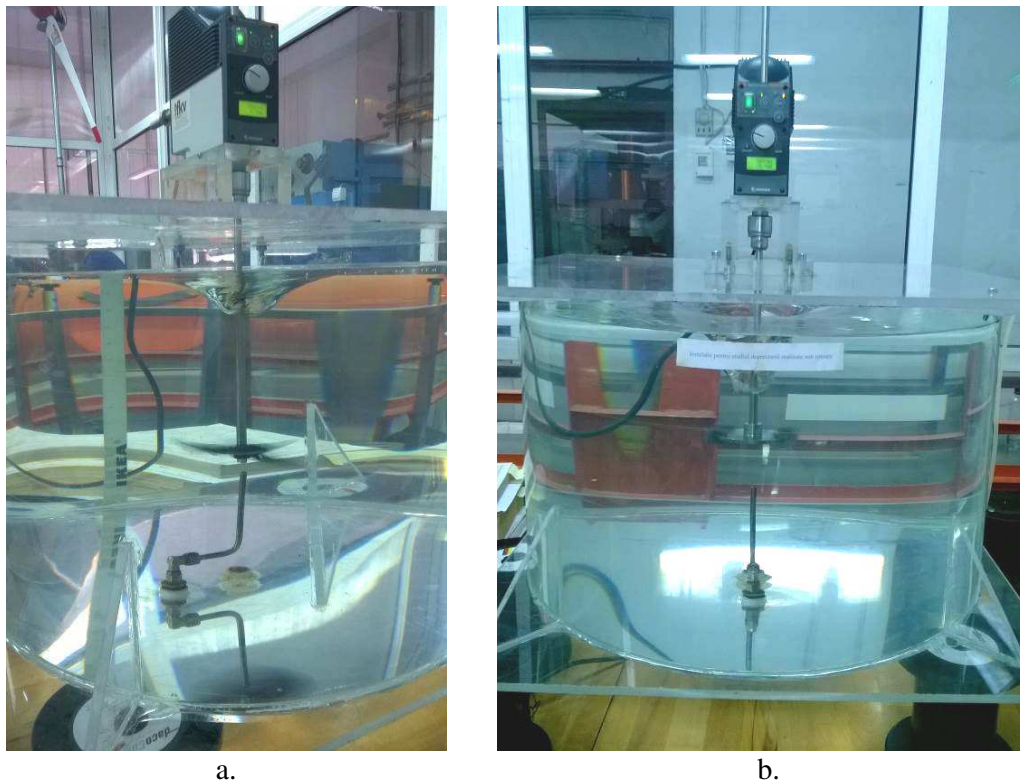

Figure 1: The experimental setup: the two blades propeller (a) and the Rushton turbine (b).

Three bodies of significantly different shapes were used: a Rushton turbine with 105 mm diameter and 20 mm width, a two blades propeller with 160 mm diameter and 30 mm width and an ellipsoidal body with 160 mm diameter and 30 mm width in the center (a flying saucer shape). The bodies were tested in a speed range between 60 rpm and 600 rpm.

The measurements were made in six different points, vertically located on the center axis of the vessel, at 125, 135, 145, 155, 165 respectively 175 mm from the vessel bottom. For each body the mean value of the momentum was determined, for the specified speed range.

The momentum values obtained and the power consumption for each body are presented in Table 1.

Table 1: Momentum and power consumption for the objects studied

N [rpm]	Rushton turbine		Two blades propeller		Ellipsoidal body	
	Momentum mean value * 100 [N·m]	P [W]	Momentum mean value * 100 [N·m]	P [W]	Momentum mean value * 100 [N·m]	P [W]
60	2.28	0.143	2.10	0.132	2.00	0.126
100	2.95	0.309	2.40	0.251	2.15	0.225
150	4.25	0.668	2.80	0.440	2.35	0.369
200	5.60	1.173	3.38	0.709	2.55	0.534
250	7.35	1.924	4.17	1.091	2.85	0.746
300	9.40	2.953	5.10	1.602	3.05	0.958
350	11.92	4.368	6.38	2.340	3.35	1.228
400			7.87	3.295	3.50	1.466
450					3.70	1.744
500					3.90	2.042
550					4.15	2.390
600					4.35	2.733

The variation of the power consumption depending on the engine speed and the shape of the rotated body is shown in Figure 2.

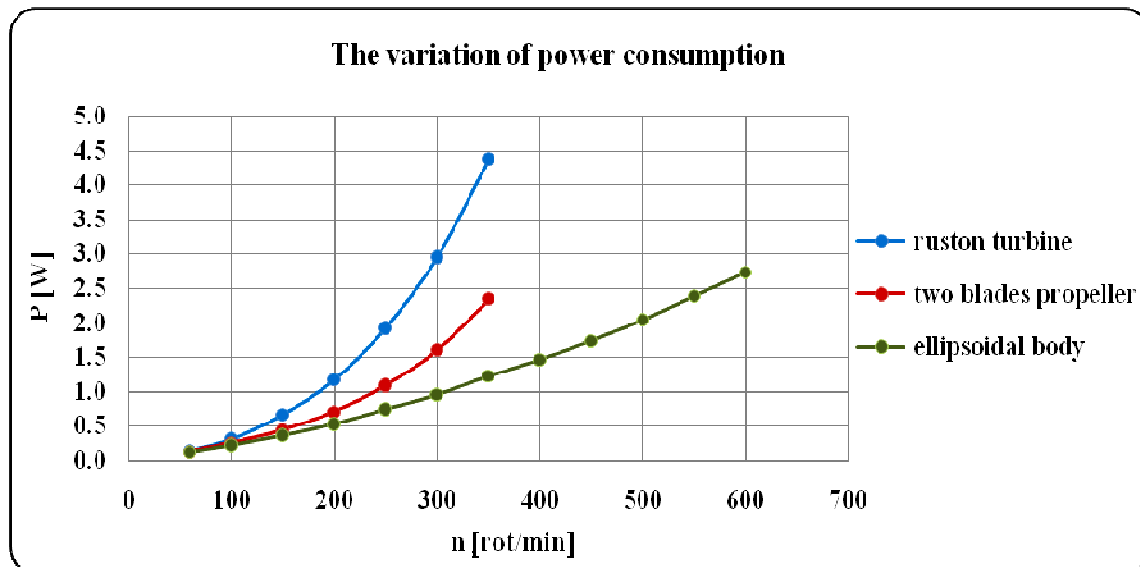

Figure 2: The variation of the power consumption for the objects studied

The Rushton turbine pushes the water mainly along the radius of its horizontal disk and needs higher power consumption, as we can see in Figure 2.

The two blades propeller has a certain degree of reaction and sends the water downwards. Because the water is moved to the bottom of the vessel, less effort is made. It consumes less power, as shown in Figure 2.

The flying saucer has the minimum effect in moving the water. Therefore, this ellipsoidal body requires minimum momentum and minimum power consumption. Instead, it is very



useful to heat slowly a fluid from the inside. More precisely, it can do that from the center of the fluid to the exterior. We would like to underline this important aspect, because fluids are usually heated from the exterior. The values of the resulting temperature variation calculated for 24 hours of functioning are shown in Table 2.

Table 2: The temperature variation for the ellipsoidal body

n [rpm]	60	100	150	200	250	300	350	400	450	500	550	600
$\Delta t = Q/mc$ [°]	0.026	0.046	0.076	0.110	0.154	0.198	0.253	0.303	0.360	0.422	0.493	0.564

More than that, in the third case, the increase in temperature can be very slow. Or, if precise calculus is made, by rotating continuously the flying saucer inside the fluid, the temperature can be kept constant as long as the heat produced is equal with the heat lost through the vessel walls.

### 3. CONCLUSIONS

This paper presents the effects produced in a mixing vessel by rotating three bodies of different shapes. The best object that has been used in our study on mixing fluids was the Rushton turbine. Because it requires higher power consumption, the mixing effect will be better.

The second one, useful in mixing fluids is the two-blade propeller. It also has an increased capacity to rotate the fluid inside the vessel in the vertical plane.

The flying saucer is not so useful for mixing. Instead, it can be used for accurately heating a fluid from the inside to the outside.

**Acknowledgement** The research was conducted within NUCLEUS Program, contract no. PN18240202, *Drives, analysis and control systems for increasing the energy efficiency of industrial equipment and installations used in electrical engineering, mechatronics and fluidics* financed by the Romanian Executive Agency for Higher Education, Research, Development and Innovation Funding.

### References

- [1] Mândrea L., Băbuțanu C., Oprina G., *Impellers shape influence on the heat induced in liquid environments*, proceedings of the 6<sup>th</sup> International Conference on Thermal Equipment, Renewable Energy and Rural Development TE-RE-RD 2017, 8-10 iunie 2017, Moeciu, România, ISSN 2359 – 7941 p. 77-82.
- [2] Butcher M., Eagles W., 2002, *Fluid mixing re-engineered*, Chemical Technology Journal, <https://www.tcetoday.com/~media/Documents/TCE/Articles/2002/733/733mixing1.pdf>
- [3] Rashid T., Rizvi S.Z.H., Malik S.R., *Study the effect of impeller design on power consumption*, February 2013, International Journal of Chemical and Environmental Engineering, Volume 4, No. 1, p. 21-24.
- [4] Furukawa H., Kato Y., Inoue Y., Kato T., Tada Y. and Hashimoto S., *Correlation of Power Consumption for Several Kinds of Mixing Impellers*, Hindawi Publishing Corporation International Journal of Chemical Engineering, ISSN: 1687-8078 (Online), Volume 2012, Article ID 106496, 6 pages, doi:10.1155/2012/106496.
- [5] Adamiak R., Karcz J., *Effects of type and number of impellers and liquid viscosity on the power characteristics of mechanically agitated gas—liquid systems*, J. Chem. Pap. (2007) 61: p. 16-23, doi:10.2478/s11696-006-0089-6.
- [6] Yoshida M., Ito A., Yamagiwa K., Ohkawa A., Abe M., Tezura S. and Shimazaki M., *Effect of impeller clearance on power consumption of unsteadily forward-reverse rotating multiple impellers in an unbaffled agitation vessel*, 2002, Latin American applied research, vol. 32, no. 2, ISSN online 1851-8796 p. 189-194.
- [7] Rao D. and Mahey C., *Studies on Impeller Design on Power Consumption from Temperature Rise Data In a Stirred Tank*, AIChE Annual Meeting, Philadelphia PA, November 16-21, 2008, North American Mixing Forum (06), paper #434a, <https://aiche.confex.com/aiche/2008/techprogram/S6955.HTM>

# COMPARATIVE ANALYSES OF AIR FLOW CHARACTERISTICS, THROUGH TWO VARIANTS OF PROTOTYPED DEVICE FOR FINE DUST PARTICLES CONCENTRATION MEASUREMENT

Mijorski S<sup>1</sup>., Ivanov M.<sup>2</sup>

<sup>1</sup>PhD, SoftSim Consult Ltd., Consultant at Technical University of Sofia, FPEPM, Department: "Hydroaerodynamics and Hydraulic Machines", Sofia 1000, Bulgaria

<sup>2</sup>Senior Assist. Professor, PhD, Technical University of Sofia, FPEPM, Department: "Hydroaerodynamics and Hydraulic Machines", Sofia 1000, Bulgaria

## ABSTRACT

In the recent years, it was documented that the main problem with the urban environment air quality in Bulgarian cities are the exceeded concentrations of fine particulate matter and associated human health related issues. With this, the need of gathering more detailed data and raising the city population awareness for the ambient conditions in close to their homes have grown.

This paper presents an innovative measuring device, designed to raise the awareness of the population about ambient air quality in the urban environment. A main aim of the study was better understanding of the air flow through the prototyped device, in order to improve its performance with means of numerical simulations. To achieve the goal, two design versions of the protective box were assessed with CFD modelling. In the first one, there is a so-called "protective cavity" – a free volume of air prior to the main sensor position. In the second design, this cavity does not exist and the sensor contacts through extruded circular opening with the environment. A comparative analysis of the two variants is represented by velocity and relative pressure fields' visualizations.

## 1. INTRODUCTION

According to a recent World Health Organization (WHO) report, over 18 000 people die prematurely every year in Bulgaria, as a result of the polluted air breathed during their lives (WHO, 2016). The quality of the urban environment air is monitored by the Ministry of Environment and Water, through the National Monitoring, Control and Information System. However, there is no official data in the country, on the link between air pollution and the citizen's health (Melteva, 2016). In a number of reports from various departments, it is stated that the main problem with the quality of the ambient air at the national level is the exceeded concentrations of Fine Particulate Matter (FPM). According to European statistics, some of the Bulgarian cities take the first places in Europe, considering the high levels of dust concentration in the air (Melteva, 2016; Nikolova et al., 2014).

FPMs are dangerous to human health and are most often associated with pulmonary diseases. According to the European Lung Foundation (ELF), lung diseases account for 1/6 of the total mortality in the world and are one of the most significant health problems both in Europe and worldwide. It was documented that more than 600 000 people die of lung disease in the EU Member States every year (ELF, 2013). However, it is also known that there is a risk of occurrence of these illnesses even 30 years after the exposure to high levels of air pollution.

---

<sup>2</sup>Sofia 1000, Bulgaria, "Kliment Ohridski" Blvd. #8, Technical University – Sofia, +359898240221, [m\\_ivanov@tu-sofia.bg](mailto:m_ivanov@tu-sofia.bg)

Moreover, it is important to mention, that between 1.5 and 2 million deaths per year were reported globally, due to the polluted air in the indoor areas. The level of ambient air pollution is directly related to the quality of the indoor air, inhaled by the occupants. In many cases, more than 900 types of hazardous compounds are present in the indoor air, considered as pollutants from different sources. The concentration of some of these pollutants can reach up to 5 times higher than in the outside air. According to the WHO and ELF organisations, the polluted air in the indoor environment is the eighth risk factor for disease occurrence and is responsible for 2.7% of all diseases worldwide (ELF, 2013; WHO, 2016).

All mentioned in the above reveals the need for development of various engineering solutions for better understanding of these issues. New, broad-based approaches are needed to raise the awareness of the people for the quality of the air inside and outside of their homes. This pointed to the purpose of the presented paper - to demonstrate an innovative solution for increased awareness, by introducing an electronic measuring device, as well as the application of Computational Fluid Dynamics (CFD) technologies to evaluate its performance in regards of air flow characteristics assessment.

## 2. "DUST COUNTER" PROJECT

"Dust Counter" is an innovative project developed by Greenpeace Bulgaria ([www.greenpeace.org/bulgaria/bg/](http://www.greenpeace.org/bulgaria/bg/)), together with "For the Earth" ([www.zazemiata.org](http://www.zazemiata.org)) and "Robotev" ([www.robotev.com](http://www.robotev.com)), which aims to raise public awareness for the quality of ambient air in the urban environment („*Greenpeace-Bulgaria*", 2018). The global purpose of the devices is to alert users for the presence of FPM air pollution above the pre-set limits in close to their homes. However, these devices are nonprofessional, built on an open platform (Arduino, <https://www.arduino.cc/>) and are fully oriented towards the citizens, not for the scientific community.

The primary sensor for measurement of FPM from 2.5 $\mu\text{m}$  to 10 $\mu\text{m}$  - GP2Y1010AU0F (Sharp) is compact and commercially available. It has been tested with the MIE pDR-1500 (Thermo Scientific) laboratory-calibrated professional measuring instrument and both devices showed similarity in the response to the changes in the degree of dustiness in the tested medium. However, due to the specifics of the project of this "do it yourself" device, the measured data cannot be considered scientifically accurate and directly compared to laboratory or professional calibrated instruments.

In January 2017, several pilot devices have been installed on the territory of Sofia, one of them being at the Technical University of Sofia. The device was assembled by the team of "Engineering Design Lab" (<http://design.tu-sofia.bg/>) and the design of the protective box was created by Assoc. Prof. Georgi Chervadinev. The laboratory is able to prove the associated design quality of the device, as shown in *Georgieva, (2011)*, but the outer casing of the device still needs to be assessed. It is the device's protective box that is the subject of the study in the presented paper.

The shape and the type of the "Dust Counter" box are entirely open for free interpretation by the users, which is the major inspirational idea in the project itself. The main components of the device, such as the microcontroller circuit board, the Wi-Fi module, the FPM sensor, the fan, the battery, and the wiring are fixed, but the boxes are open for interpretation. The only requirement is that the FPM sensor and the fan contact freely with the environment. But also, in order to ensure proper operation of the main sensor, the manufacturer imposes a specific mounting position relative to the air flow through the sensor, which must also be taken into consideration. It means that the correct design of the "Dust Counter" protective box is a key factor for optimal performance of the device. This determines the aim and the tasks of the presented numerical study.

### 3. AIM OF THE PRESENTED STUDY

The aim of the present study is to analyse the air flow through two versions of a prototyped instrument for measurement of the ambient air FPM concentration. A comparative analysis, based on the CFD methods, is performed to achieve the goal.

Two design variants of the outer case have been studied. In the first variant a so-called “protective cavity” is introduced, which ensures an additional free volume of air before the positioning the main sensor. In the second option, this cavity does not exist and the sensor contacts through extruded circular opening with the environment. The comparative analysis of the two variants of the protective box is represented by velocity and relative pressure fields visualizations.

### 4. GEOMETRICAL MODEL AND BOUNDARY CONDITIONS

Two steady state simulations were conducted, to perform the comparative analysis between the two versions of the prototyped device. In both simulations, an ENGYS® (www.engys.com) version of the OpenFoam® computational code (www.openfoam.com) was implemented. The numerical model used in the study is based on the Reynolds Averaged Stress equations (RANS) method in combination with the  $k-\omega$  turbulent SST (Shear Stress Transport) (Menter, 2011).

To ensure steady state conditions, 4000 iterations with simpleFoam solver (OpenFOAM® UG, 2016-1) were conducted to reach a converged solution. An additional 1000 iterations were after that performed, to average and refine the fluctuations of the simulated field values. The calculation and linking of the velocity and pressure equations was accomplished by the SIMPLE algorithm. Detailed algorithm and solution relaxation factors information is presented in (OpenFOAM® UG, 2016-3).

The computational domain is confined inside the prototyped device and protective box. It comprises the beginning of the fan body, top cavity, protective cavity, and expansion box at the bottom of the inlet port (Figure 1). The expansion box under the inlet port is designed to reduce the impact of the CFD domain boundary conditions to the flow at the inlet section of the device.

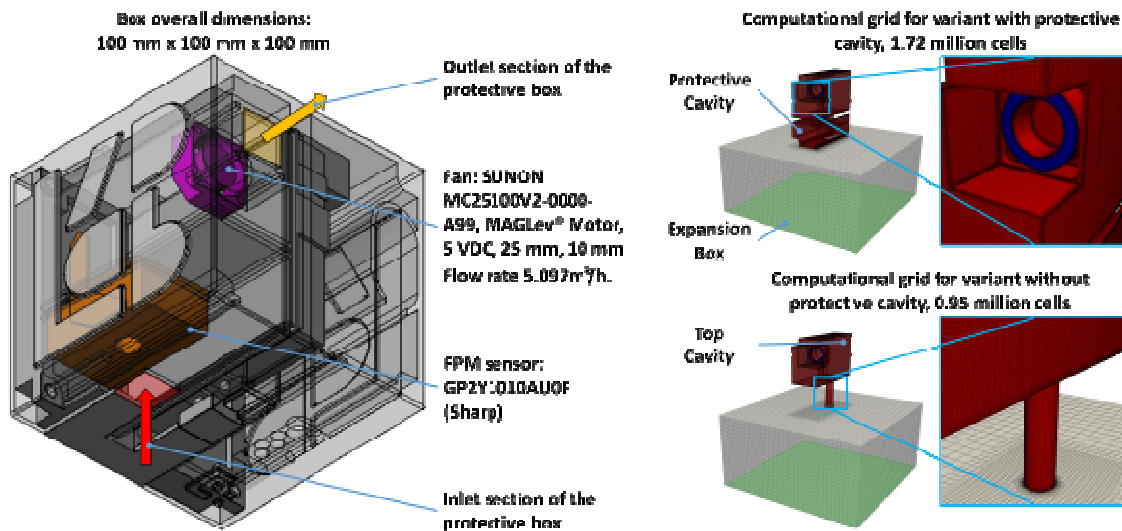

Figure 1. Geometrical model and computational domain

The computational domain was discretised with use of 1 730 000 control volumes for the prototype with a protective cavity and 950 000 control volumes for the second prototype without a protective cavity. The base cell size in the grid was 5 mm, but in order to precisely simulate the geometry in the box, the cell size in this area was reduced to 0.155 mm and in the boundary layer of the wall surfaces down to 0.0745 mm.

Three different boundary conditions were defined: smooth surface for all walls with specified roughness of 0.001 m (sand grain roughness); fan area with outlet flow rate of 1.4 l/s; opening (free inlet/outlet) boundary condition at the inlets of the expansion box with a defined relative pressure of 0 Pa and turbulent flow characteristics of 5.0%.

## 5. CFD RESULTS

The results from the numerical simulations are presented on Fig. 2 and 3, by the visualized velocity and relative pressure fields. The visualisation of the numerical fields of the prototyped device demonstrated a presence of a recirculation and low velocity zones in the "protective cavity". This effect could contribute to stagnation and accumulation of particulate matter in the protective cavity, which in turn could be a prerequisite for a faulty operation of the FPM sensor and increased differential pressure the fan component of the device has to overcome, leading to reduced flow of ambient air. These need to be considered in the design and development of the "Dust Counter" protective boxes.

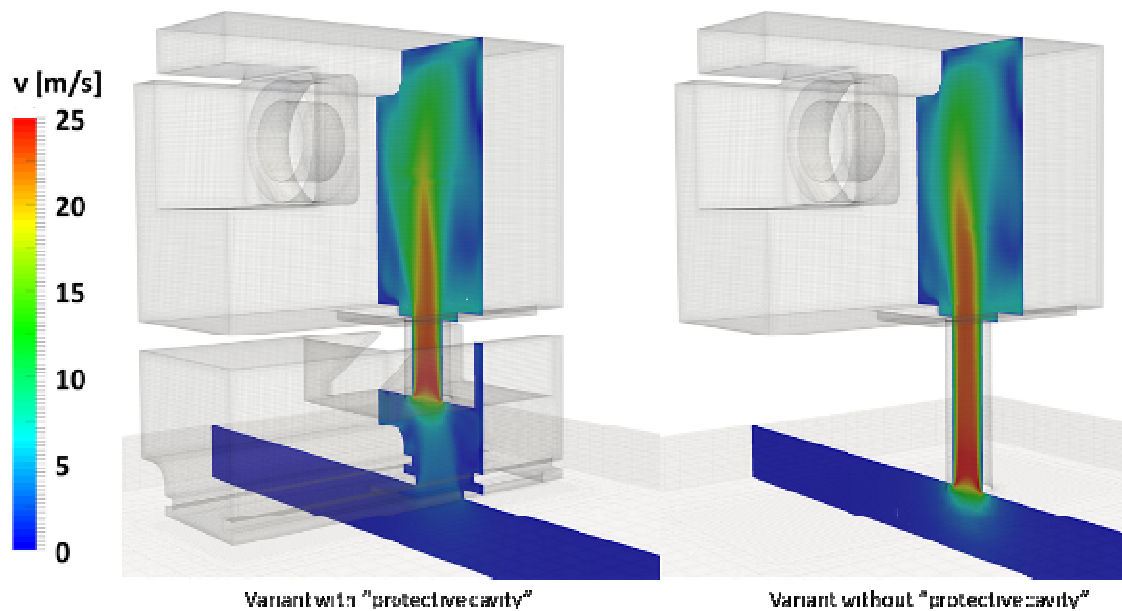

Figure 2. Velocity fields for the two prototyped devices

Overall, the numerical results do not show significant differences in the flow in the top cavity of the box, just before the fan. Considering the small dimensions of the device and the boundary condition for the smooth surface of the walls, there are no significant differences in the pressure fields (Figure 3). The resulting flow pressure losses in both variants are identical, taking into account the above mentioned boundary conditions. Additional studies, under different boundary conditions would help to fine-tune the fan characteristics and to optimize the overall performance of the device. This also would help in quantifying the differential pressure that the fan has to overcome and whether this will lead to significant flow rate reduction through the device in the assessed protective box models.

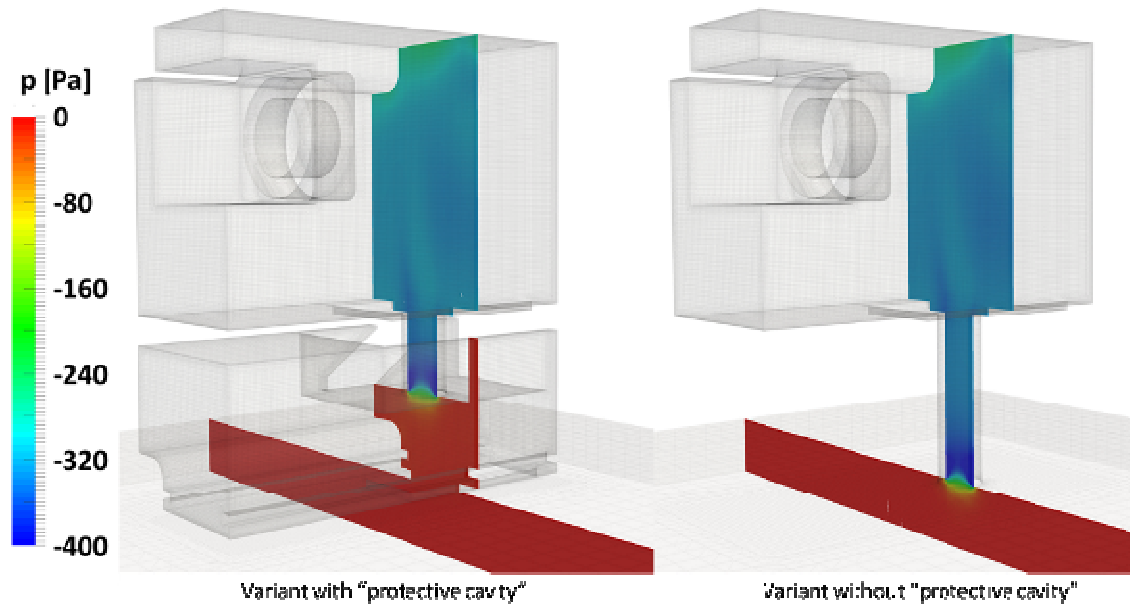

Figure 3. Pressure fields for the two prototyped devices

In order to completely assess the effect of the "protective cavity", an additional analysis is needed, by means of the "Age of Air" parameter and passive scalar field calculation. This additional processing module will visualize the "protective cavity" areas in which the air would last for longer time and the FPM would stagnate and accumulate. Also, for a complete assessment of the device performance, it is advisable to carry out a study with tracer particles in the mainstream, which includes a modelling of FPM distribution.

## 6. CONCLUSIONS

Air flow, through two variants of a prototyped device for FPM concentration measurement, was studied and a comparative CFD based analysis was performed.

Two variants of the design of the protective box were considered - with and without "protective cavity", prior to the main sensor positioning. The comparative analysis between the two variants demonstrates the presence of a low velocity in the box and a recirculation zone in the "protective cavity". This effect would contribute to stagnation and accumulation of particulate matter in the cavity, which in turn could be a prerequisite for improper functioning of the FPM sensor.

The numerical results do not show significant differences in the flow in the top cavity of the box, prior to the fan. Taking into account the small dimensions of the device and the boundary condition for smooth surface on the walls, there are no significant differences in the pressure fields. The resulting flow pressure losses in the two variants are identical, within the assumed boundary conditions.

It is believed that the presented research study will facilitate the future development of the protective boxes for the presented devices for measurement FPM concentration in the ambient air.

## References

- [1] Georgieva B., “Theoretical Aspects of application of Engineering Value Analysis to evaluation of design products”, 8th International Congress „Machines, Technologies, Materials”, 18–21.09.2011, Varna, Bulgaria, year V, issue 8/2011, pp. 14-17, ISSN 1313-0226, 2011;
- [2] „Greenpeace-Bulgaria”, project: „Dust Counters“, <http://www.greenpeace.org/bulgaria/bg/novini/2016/prahobroyachi/>, last visit: 25.03.2018r.;
- [3] European Lung Foundation, “Lung health in Europe – facts and figures”, Report, ISBN 978-1-84984-058-3, 2013;
- [4] Melteva B., “Annually, over 18 thousand become victims of the polluted air in Bulgaria”, [www.dnevnik.bg](http://www.dnevnik.bg), publication – 16. February. 2016r.;
- [5] Menter F., “Turbulence Modelling for Engineering Flows”, ANSYS Inc. , 2011;
- [6] Nikolova D., Tsvetkov A., Ganev P., Aleksiev Y., Slavova Z., „Regional profiles: Development Indicators, Institute for Market Economics, ISBN 978-954-8624-40-4, 2014r.
- [7] OpenFOAM® User Guide: 3.5 Standard solvers. <http://cfd.direct/openfoam/user-guide/standard-solvers/>, 2016;
- [8] OpenFOAM® User Guide: 4.5 Solution and algorithm control. <http://cfd.direct/openfoam/user-guide/fvSolution.>, 2016;
- [9] World Health Organization, “Monitoring Health for the Sustainable Development Goals”, Report, ISBN 978 92 4 156526 4, 2016;

# ABOUT THE PROBLEMS IN LIGHTNING PROTECTION IN PHOTOVOLTAIC POWER STATIONS

Ivaylo Nedelchev<sup>1</sup>  
Technial University of Varna

## ABSTRACT

One of the most used source of energy in so-called "green power stations" are photovoltaic stations (PVS). They are the main type of installations for generating energy from the Sun. Due to the outdoor installation of the PVS equipment the forces of nature have influence on it and respectively there is a risk of some kind of rejections or even material losses. The landscape environment such as high hills, trees or ponds placed in dangerous proximity, often causes risk of direct or indirect lightning strikes during the storm weather. This paper overview the physical aspect in case of big lightning strike, considering the crucial factors which influence the process and gives a main approach for preventing or restriction the damages in that type of incidents.

## 1. INTRODUCTION

One of the most used source of energy in so-called "green power stations" are photovoltaic stations (PVS). They are the main type of installations for generating energy from the Sun. Due to the outdoor installation of the PVS equipment the forces of nature have influence on it and respectively there is a risk of some kind of rejections or even material losses. Well known fact is, that the surface of the PVS are spread onto a vast area. For big PVS with peak power of 10 - 50 MWp are needed about 20 - 110 ha [1]. The PVS often are located nearby hills, mountains or in a close proximity of the ponds or high objects: trees, lines of the electro distributing companies. This landscape environment causes risk of direct or indirect lightning strikes during the storms. According the standard IEC 62305-1,3:2006, for the lightning protection levels (LPL from I to IV), the risk of lightning strike is between 1% and 16% [2]. The different statistical data show, that 5% - 15% from all lightning strikes, which depends on the earth landscape, exceed 100 kA peak current [3, 4]. For minimizing the risk for PVS equipment from overvoltage and inducted electrical and magnetic field of the lightning strike, surge protection devices (SPD) with gas discharged tube (GDT) or metal-oxide varistor element (MOV) are used [5]. There exist cases, when lightning strikes directly within the area of the PVS. This causes a massive inflow of the charge into the ground, as well as large conductive currents. This paper overview the physical aspect of the problem and gives a main approach for preventing or restriction the damages in that type of cases.

## 2. OVERVIEW OF THE PROBLEM

In the PVS, the earthing system often is executed, as the net from welded metal busbars, buried deep (1 m.) under the ground surface [1]. The lightning protection system (LPS) consists of metal rods, on the spike of which, devises based on the early streamer emission (ESE) technology are mounted [5]. Both earthing and lightning protection systems are not connected with galvanic bond. Their earthing electrodes must be separated on the safety

---

<sup>1</sup> Varna, Bulgaria, Technical University of Varna, 1 Studentska str., phone number +35952 383 249 email: [iynedelchev@abv.bg](mailto:iynedelchev@abv.bg)



distance. In the precautions of the working regulation standards for designing the PVS, is used term “safety insolation distance” [3, 6]. This is the distance between lightning protection earthing electrode and close located metal element of the construction, which can prevent the influence from the lightning, as flashover or inducted overvoltage. This distance is not strictly defined. In some standards is mentioned to be minimum 2.5 - 5 m. This is crucial point in case of accidental and extremely increasing discharge, which could be formed by lightning strike. If the lightning current exceed the middle statistical value, then the supposed safety distance, could be not sufficient for preventing damages in the equipment.

Probability distributions during the peak current of the lightning strikes to the ground’s objects shows average peak current of 51 kA for negative and 38 kA for positive strikes. Usually the number of the negative strikes on the ground is much more than the positive [3].

The main possibility of the influence over the PVS equipment includes two main ways:

- Inducted overvoltage. It occurs, when close located PVS elements (electrical or constructive), are formed as a loop and placed close to the lightning protection system rods (LPS).

- Via electrostatic field in the ground. The soil with its specific electrical parameters, distribute the charge inflow in order to generate electrical potentials in buried metal parts under the ground.

The more the number of the LPS rods is, the more the number of possible charge sources in the PVS area are. The ESE technology minimizes the number of lightning rods in the area of the PVS. If the earthing points of the LPS are not safety distanced from the parts of the PVS equipment, then could be expected higher risk of the inducted overvoltage.

The main question is: in typical PV panels distribution within the area of the PVS, how can be defined and calculated the safety distance between LPS electrodes from one side and parts of the power equipment and earthing system from the other side.

An example distribution of the main units in the area of the PVS is given in the figures below (Figure 1 a, b). Protective lightning rods are marked, including safety insulating distances  $D_1$  from the metal construction of the PV panels and distance  $D_2$  from the closest points of the foundation grounding net (FGN). These cases are the most common and therefore the most important is to consider the interaction between this both systems - earthing and lightning protection.

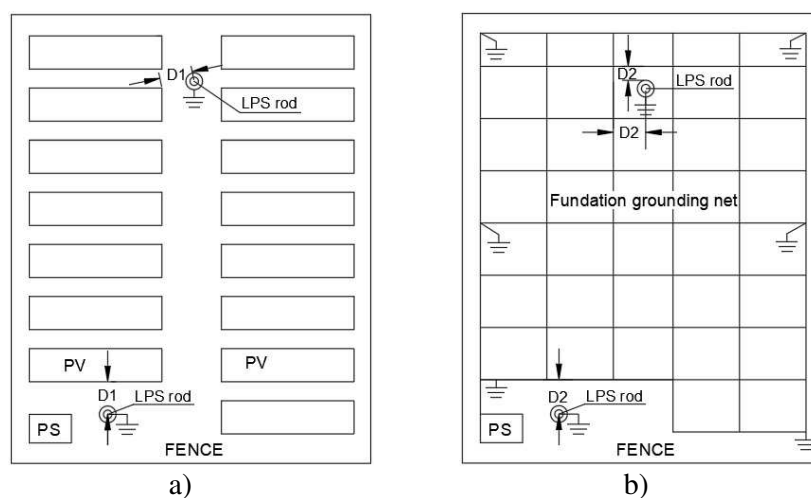

Figure 1: Similar distribution of the ESE lightning rods into the PV panels area in one PVS with insolation distances ( $D_1$ ) (a). Insolation distances ( $D_2$ ) of the LPS rods from the closest points of the main element of the earthing system – foundation grounding net (FGN) (b).

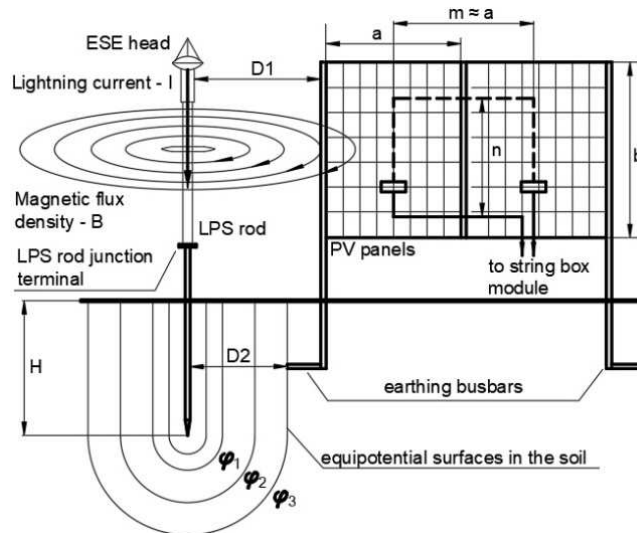

Figure 2: Interaction of the LPS rod over the parts of the PVS

The position of the rods of the LPS is chosen, taking into account two main requirements: the protective zones must cover the whole area of PVS and LPS rod's shadows, which fall over the PV panels must reduce the generated power with minimum effect. The distance between earthing points of the LPS and FGN, must be so large in order to reduce lightning charge, distributed under the ground via soil resistivity [5]. The diagram of the location and interaction between the LPS rod and PV system connected to FGN is shown on the Figure 2. This is a typical case, which illustrate the electrostatic and the electromagnetic interaction. The crucial factor influencing on the PV panels is the shape of the lightning current, which main parameters are:

- peak current -  $I_p$ , kA - maximum value of the lightning current;
- rising time -  $\tau_1$ ,  $\mu\text{s}$  - time for reaching peak current;
- fall time -  $\tau_2$ ,  $\mu\text{s}$  - time to decay from peak to half-peak [4].

According IEC standard 61643-11 for testing surge protection devices, the main ratio for  $\tau_1/\tau_2$  should be expressed with the next values: 10/350  $\mu\text{s}$  and 8/20  $\mu\text{s}$  [7].

### 3. PHYSICAL BASE OF THE LIGHTNING INFLUENCE

From Figure 2 is obvious that the metal frame of the PV panel construction is influenced by the lightning current flowing through the LPS and by the voltage of the equipotential surfaces formed into the soil under the ground. This process consists of two impacts:

- Influence due to the generated potential difference between two points, which belong to the equipment of the PVS (e.g. grounded construction and conductive electrical line).
- Influence of the magnetic field of the current, passing through the LPS rod.

#### 3.1. Influence of the electrical potential

The question about the distribution of the charge into the ground is very complex. To simplify the situation it is assumed cylindrical form of the LPS rod, which will create the shape of the equipotential surfaces into the ground, composed geometrically of cylindrical and half-sphere surfaces, as it is shown on the Figure 2 [8]. According the Ohm's Law, the electric field strength ( $E$ ) could be expressed as the product of soil resistivity ( $\rho$ ) and lightning current density ( $j$ ):  $E = \rho \cdot j$ . Therefore, with this type of LPS rod and shape of the equipotential surfaces, the current density can be obtained as:

$$j = \frac{i}{2\pi \cdot D_2 \cdot H + 2\pi \cdot D_2^2}, \quad (1)$$

where  $i$  is the lightning current,  $D_2$  is the distance from the LPS rod,  $H$  is the depth of the LPS rod. If the electrical potential in the far space point is accepted to be zero, than for the soil can be written [8, 9]:

$$\varphi(D_2) = \int E dD_2 = \int \frac{\rho \cdot i}{2\pi \cdot D_2 + 2\pi \cdot D_2^2} dD_2 = -\frac{\rho \cdot i}{2\pi \cdot H} \cdot \ln\left(\frac{H}{D_2} + 1\right). \quad (2)$$

The statistical data show that 5% of the lightning strokes are greater than 100 kA [3]. The soil resistivity  $\rho$  depends on its type, salinity, moisture, temperature etc. It manifests impedance behavior, which is frequency depending value. For surface type of soils its average limit values for resistivity are assumed to be between 50 and 200  $\Omega \cdot m$  [10, 11]. If the depth of the LPS rod  $H$  is 2 m., can be calculated electrical potential into the ground. The obtained results for the absolute value of the generated potentials  $|\varphi(D_2)|$  are represented in the Table 1 and Figure 3. It is obvious that obtained values for the potentials exceed much more the breakdown voltage of the PVS equipment.

Table 1: Electrical potential ( $\varphi(D_2)$ ) by resistivity 50  $\Omega \cdot m$  and 200  $\Omega \cdot m$

	$\rho = 50 \Omega \cdot m$					$\rho = 200 \Omega \cdot m$				
$I_p, kA$	51									
$ \varphi(D_2) , kV$	104	68	37	26	19	415	273	148	102	77
$D_2, m$	3	5	10	15	20	3	5	10	15	20
$I_p, kA$	100									
$ \varphi(D_2) , kV$	203	134	73	50	38	813	536	290	199	152
$D_2, m$	3	5	10	15	20	3	5	10	15	20

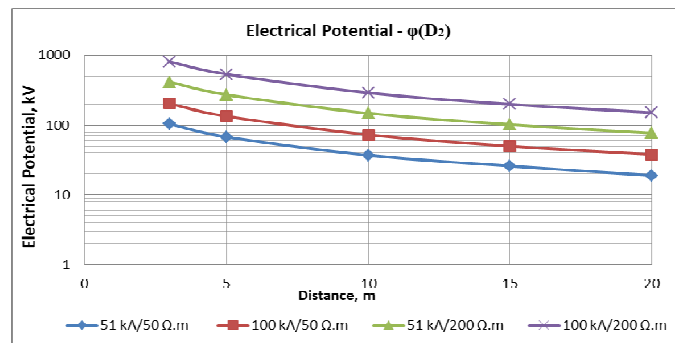

Figure 3: Dependence of the ground potential ( $\varphi$ ) on the distance ( $D_2$ ) from the LPS rod

### 3.2. Influence of the magnetic field.

One of the main factors for the damages in the PVS is the slope of the lightning current ( $S_I = di/dt$ ). According to the standard lightning's rising and decay times ( $\tau_r/\tau_d = 10/350 \mu s$ ) and assumed average peak current ( $I_p = 51 kA$ ), the front ( $S_{IF}$ ) and decay ( $S_{ID}$ ) slopes are calculated as:  $S_{IF} = 5.1 kA/\mu s$ ,  $S_{ID} = 0.146 kA/\mu s$ . The statistical data for less than 5% of the lightning strikes show front current steepness above 100 kA/ $\mu s$  [3]. These values are most

important for estimation the influence of the current's magnetic field, generated from the lightning. The total induced magnetic flux in the loop with sizes  $m/n$  (Figure 2) placed into the PV panels area can be calculated as [8]:

$$\Phi = \frac{\mu_0 \cdot i \cdot n}{2\pi} \cdot \ln \left[ \frac{\left( D_1 + \frac{a}{2} \right) + m}{D_1} \right] \quad (3)$$

where  $m$  (width) and  $n$  (height) are dimensions of the wiring loop,  $a$  is width of the PV panel,  $D_1$  is distance to the LPS rod (Figure 2 a),  $\mu_0$  is permeability of vacuum ( $4\pi \cdot 10^{-7}$  H/m). Thus, the induced electromotive voltage  $e(t)$  on the terminals of the loop with sizes  $m/n$  (Figure 2), placed into the PV panel's construction frame will be:

$$e(t) = -\frac{d\Phi}{dt} = -\frac{\mu_0 \cdot n}{2\pi} \cdot \ln \left[ \frac{\left( D_1 + \frac{a}{2} \right) + m}{D_1} \right] \cdot \frac{di}{dt} \quad (4)$$

Depending on hookup configuration of the PV panels, the sizes and respectively the area of the loop can vary in wide span. The average sizes of the panels are:  $a = 1$  m.,  $b = 1.5$  m [1]. The maximum loop sizes  $m/n$  according the position of the panel's junction box are:  $m \approx a$ ,  $n = (0.7 \div 0.9) \cdot b$  [1]. Thus  $m/n \approx 1/1.2$  m. The results for induced maximum of the electromotive voltage ( $E_M$ ) in distance domain  $D_1$ , for two different sizes of the loop  $m/n = 1/0.1$  m. and  $m/n = 1/1.2$  m. are given in the Table 2 and Table 3 and respectively on the graphs shown in the Figure 4 a), b).

Table 2: Results for  $E_M$  by loop sizes  $m/n = 1/0.1$  m.

$D_1$ , m	3	5	10	15	20
$E_M$ , V (by $di/dt = 5.1$ kA/ $\mu$ s)	41.4	26.8	14.3	9.7	7.4
$E_M$ , V (by $di/dt = 100$ kA/ $\mu$ s)	811	525	280	191	145
$E_M$ , V (by $di/dt = 200$ kA/ $\mu$ s)	1622	1050	559	381	289

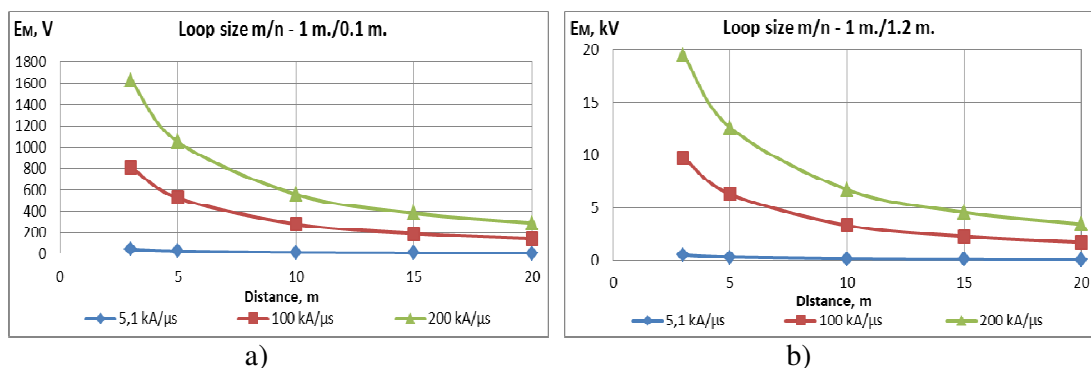

Figure 4: Dependence of the  $E_M$  on the distance ( $D_1$ ) from the LPS rod (a). Dependence of the  $E_M$  on the distance ( $D_1$ ) from the LPS rod (b)

Table 3: Results for  $E_M$  by loop sizes  $m/n = 1/1,2$  m.

$D_I$ , m	3	5	10	15	20
$E_M$ ,kV by $di/dt = 5.1$ kA/ $\mu$ s	0.5	0.32	0.17	0.12	0.09
$E_M$ ,kV by $di/dt = 100$ kA/ $\mu$ s	9.73	6.3	3.35	2.9	1.74
$E_M$ ,kV by $di/dt = 200$ kA/ $\mu$ s	19.5	12.6	6.71	4.57	3.47

According to the SPD parameters, rated surge voltage ( $U_s$ ) is between 1.5 kV and 6 kV; the lightning protection class define lightning current span from 3 kA to 200 kA [5]. The obtained results show, that even by big loop area on average steepness of the lightning current (5.1 kA/ $\mu$ s), SPD can suppress the inducted overvoltage, which is less than rated surge voltage. Contrariwise, the case by big loop area combined with lightning current (with steepness above 100 kA/ $\mu$ s) requires both: PVS equipment to be located more than 10 - 15 m. from the LPS rod and usage of the higher class lightning protection devices.

#### 4. CONCLUTIONS

The considered general cases of the extremely powerful lightning strikes represent one physical interpretation of the typical incidents during the operation of the PVS, taking into account accepted European lightning protection standards.

In the design process of each PVS, the influence of the next main factors on the equipment and respectively on the power production must be considered:

- Type of the landscape – the proximity of the highest objects nearby the PVS;
- Parameters of the soil - moisture, resistivity, salinity, variation of the temperature during the seasons;
- Steepness of the lightning current (regional statistical data).
- Peak of the lightning current (regional statistical data).
- The sizes of the conductive loops formed by the construction and electrical wires.
- The proper distribution of the LPS rods in order to be defined appropriate safety distances ( $D$ ) – as much as it is possible.

Thus the risk form extremely high inducted overvoltage will be decreased to less than 1% and the equipment losses could be minimized.

#### References

- [1] Messenger R., Ventre J., “Photovoltaic Systems Engineering”, CRC Press, 2004
- [2] IEC 62305-1 “Protection against lightning – Part 1: General principles”, IEC – standard, 2003
- [3] International Council on Large Electric Systems. Available online: <http://www.cigre.org/>
- [4] F.Heidler, Z.Flisowski, W.Zischank, Ch.Bouquegneau, C.Mazzetti “Parameters of Lightning Current Given in IEC 62305-Bckground, Experience and Outlook”, 29-th International conference on Lightning Protection, June 2008, Upsala.
- [5] “Lightning protection guide”, Dehn&Söhne, 2014
- [6] “Ordinance № 4 of 22 december 2010 on the protection of buildings, external equipment and open spaces”, MRDPW, State Gazette No 6 of 11 January 2011.
- [7] IEC 61643-11 “Low-voltage surge protective devices - Part 11: Surge protective devices connected to low-voltage power systems - Requirements and test methods”, IEC – standard, 2011.
- [8] R.G.Carter, “Electromagnetism for Electronic Engineers”, Springer, 1992.
- [9] Lilyanova I., Analytical approach for calculation of the electric field induced by an axisymmetric current exciter, “Electrical engineering”, ISSN 0861-4717,2015, vol.5-6, pp.2-8
- [10] Md. Abdus Salam, Quazi Mehbubur Rahman, Swee Peng Ang, Fushuan WEN, “Soil resistivity and ground resistance for dry and wet soil”, Mod. Power Syst. Clean Energy, 2017 vol.5, issue 2, pp.290–297.
- [11] H. Zhivomirov, I. Iliev. Impedance Frequency Response Measurement with Matlab Implementation. Journal of the Technical University of Gabrovo, ISSN: 1310-6686, 2016, vol. 52, pp. 61-65.

# A STUDY OF THE TRANSIENT PROCESSES ON COMMUTATION OF LOW VOLTAGE LOADS

Ivaylo Nedelchev<sup>1</sup>, Hristo Zhivomirov, Yulian Rangelov, Nikolay Nikolaev, Rosen Vasilev  
Technical University of Varna

## ABSTRACT

In the real-world operation of the common public consumer of energy is increasingly encountered cases where the loads expressed capacitive or inductive type of features or generate higher order frequency harmonics. Under these conditions, it is a common situation in which a sudden change of the operation regime releases a large amount of stored energy in a short time and generates a self-inductive voltages and high inrush currents. This paper examines the main parameters of the transient processes which occurred during the commutation of the most common loads in the practice.

## 1. INTRODUCTION

Presently the common public consumer of energy is increasingly encountered cases where the load has highly reactive type impedance or generates large bandwidth of harmonics [1, 2, 3]. Under these conditions, is a common situation in which a sudden change of regime releases a large amount of stored energy in a short period of time, generate self-inductive voltages and high inrush currents. Change of the operating mode of the load is always accompanied by a transient process, which consists in adding the transient component current and voltage to their stationary component that depending on the parameters of the circuit has critically-aperiodic, aperiodic or pseudo-periodic type [1, 2, 3]. This transitional component is often expressed as generating pulses with high amplitude and fundamental frequency different from the frequency of the power source. This makes circuit of the load and switch devices as a source of interference with parameters that could affect the operation of close located devices or cause damage and failures in nearby consumers or equipment. In this relation is also staying the problem with the reaction of the conventional switching-protective devices. Often it has slower reaction compared to the rise time of the inrush currents in the chain. This report examines the main parameters of the occurred transient processes and interference generated in the circuits, including various loads by type and power. Using data acquisition system (DAQ), in real time are investigated transient processes which origin during the commutation of the most common loads in practice.

## 2. STATEMENT

In this paper are considered the cases in which loads are switched at a nominal operating voltage of 220/380 V. In the circuits of power distribution systems, the impedance of the load most often has a mixed resistive-inductive character [1, 3]. One important element in such a system is its power supply element – the transformer. It is a common case of the interruption of the voltage of the power transformer. Important stages of the transient process are the moments of commutation and the establishment of a static component. During the switching

---

<sup>1</sup> Varna, Bulgaria, Technical University of Varna, 1 Studentska str., phone number +35952 383 249 email: [iynedelchev@abv.bg](mailto:iynedelchev@abv.bg)

of the loads are created conditions for inrush currents with large amplitudes. The instantaneous value of the current in the circuit can be written as:

$$i(t) = i_{tr}(t) + i_{st}(t), \quad (1)$$

where:  $i_{tr}(t)$  is transient component of the current,  $i_{st}(t)$  is a static component, which is its nominal value after vanishing of the transient process. Considering mixed type of the load, the both component of the current can be expressed as:

$$i_{tr}(t) = \left( i_0 - \frac{U_M}{\sqrt{x_L^2 + R^2}} \cdot \sin(\varphi_u - \varphi) \right) \cdot e^{-\frac{Rt}{L}}, \quad (2)$$

$$i_{st}(t) = \frac{U_M}{\sqrt{x_L^2 + R^2}} \cdot \sin(\omega t + \varphi_u - \varphi), \quad (3)$$

where:  $i_0$  is the value of the current in the circuit in the moment of commutation,  $U_M$  – amplitude of the line voltage,  $\varphi_u$  – phase of the voltage,  $\varphi$  – phase shifting between the voltage and current,  $R$  and  $X_L$  are respectively resistance and reactance of the equivalent impedance in the circuit, which include the parameters of the feeder ( $R_{F1,2}$ ,  $X_{F1,2}$ ), power transformer ( $R_{T1,2}$ ,  $X_{T1,2}$ ,  $R_{MT}$ ,  $X_{MT}$ ) and impedance of the load ( $R_L$ ,  $X_L$ ).

Accurate assessment of the process requires consideration of the commutation time to establish the current in the circuit. Upon convergence (connection) or separation (disconnection) of the working contacts of the switch, in its air gap is excited electric arc which generates the interference in the circuit of the load with the frequency and amplitude fundamentally different from those determined at the theoretical expression for  $i_{tr}(t)$ . This interference has random character due to the dynamic of this arc and highly nonlinear nature of its electrical parameters. In the timing diagram of the current that would be manifested by the appearance of short impulses with random character [4]. Therefore, transient component can be expressed as the sum of defined and random components. Then the total current in the circuit would be:

$$i(t) = i_{irr}(t) + i_{ird}(t) + i_{st}(t), \quad (4)$$

where:  $i_{irr}(t)$  is the random part or the transient component, which is generated from the electric arc during the commutation, and  $i_{ird}(t)$  is determined part, which is expressed according eq.(2). For a proper assessment of the parameters of the transient process in the system “supply – feeder – load”, are necessary the initial data: the place of the commutation, instantaneous values of the voltage and current at the moment of the commutation, type and length of the feeder, impedance of the load, parameters of the switching devices [2]. In the report are studied the parameters of the current transient component  $i_{tr}(t)$ , arisen in commutation. For measurement the rapid changes during the transient process, can be applied various approaches [4,5]. In this case are used the measuring system type NI-USB 6211 with a sampling frequency of  $f_s = 250$  kHz. As primary transducers in all experiments, were used shunts with appropriate parameters in order to be connected in the load circuit. During the experiments are varied: the place of the switching, the length of the feeders ( $l_1$  and  $l_2$ ), the impedance of the load ( $Z_L$ ) and respectively the value of the effective current in nominal mode. It was carried out six experiments. In the first two of them is switched the primary

circuit of the power transformer (SW1 - contactor), while in the others is switched the secondary (SW2 - contactor). Figures 1 and 2 show equivalent substitute diagrams of the power supply circuits.

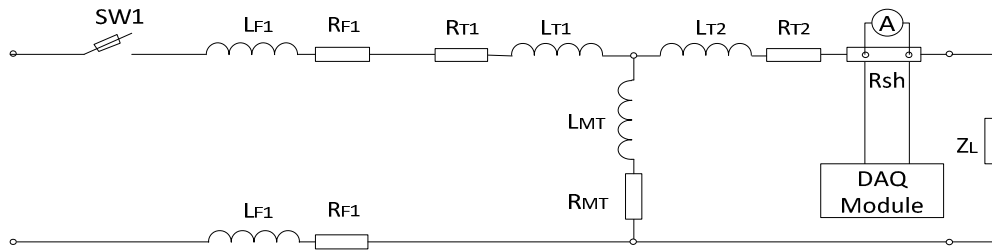

Figure 1: Equivalent circuit of the system “power supply transformer – feeder – load”. Point of commutation for experiments № 1 and 2 – SW1

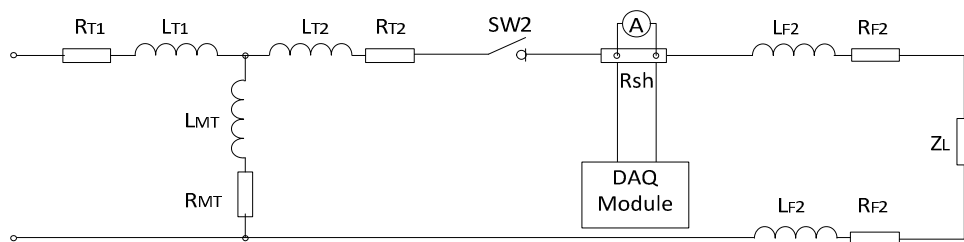

Figure 2: Equivalent circuit of the system “power supply transformer – feeder – load”. Point of commutation for experiments № 3 – 6 – SW2

Table 1: Parameters of the elements in experiments №1, 3, 4, 5, 6

№ exp.	Load type	$L_{T1,2}$	$R_{T1,2}$	$L_{MT}$	$R_{MT}$
		mH	mΩ	mH	Ω
1	Tr.AL1	0.258	42.5	100	34.4
		$L_{F1}$	$R_{F1}$	$Z_L$	$l_1$
		1.32	2.34	9.5	6
№ exp.	Load type	$L_{F2}$	$R_{F2}$	$Z_L$	$l_2$
3	AL1	5.88	69.3	11.5	21
4	AL2	5.88	69.3	5.8	21
5	AL3	5.88	69.3	3.86	21
6	IM	1.12	29.6	84.4	4

Table 2: Parameters of the elements in experiment №2

№ exp.	Load type	$L_{T1,2}$	$R_{T1,2}$	$L_{MT}$	$R_{MT}$
		mH	mΩ	mH	Ω
2	Tr.AL2	0.054	8.85	20.8	7.17
		$L_{F1}$	$R_{F1}$	$l_1$	$Z_L$
		1.68	4.44	6	158

The parameters of the main components of these elements are given in Tables 1 and Table 2. From these data, it was found that the impedance of the feeders with the lengths in



the experiments ( $I_1, I_2$ ), are much smaller than those of the power transformer and loads. Therefore, a major influence on the transient process would have the loads, transformer and the point of switching in the circuit.

In experiments №1 and 2 the transformer is burden with resistive load (Tr.AL1,2), which due to the highly inductive nature of the transformers practically is manifested as a reactive load. In experiments № 3 - 5 is switched resistive load (AL1-3) in the secondary circuit of the transformer and in experiment №6 - induction motor (IM).

The basic parameters of the current transient component in the circuit are:

- maximum of determined part of the current transient component -  $I_{Mtrd}$ ;
- peak value of the current -  $I_P$  - the maximum level of the current during the transient process (by absolute value). This is the maximum value of the current transient component  $I_{Mtr}$ ;
- dynamic span of the transient process -  $D_I$  - difference between the maximum and minimum current value during the transient process;
- time constant of the transient process -  $\tau_1$  - this is the time for attenuation of the  $I_{Mtrd}$  e times;
- time to establish nominal mode -  $\tau_2$  - this is the period between starting of the commutation and the moment when in the chain is established nominal parameters. Transient current component is completely vanished and it exist only the static component;
- commutation time -  $\Delta\tau$  - time to fully closing contacts of the contactor;

For clarity of the data, all defined peak parameters of the current ( $I_P, I_{Mtrd}$  and  $D_I$ ) are normalized by the amplitude of the current of the static component  $i_{st}(t) - I_{MN}$ .

### 3. RESULTS AND TIMING DIAGRAMS

The results obtained after conducting all experiments reveal the basic parameters of transient process at the common cases in practice. In Figures 3 to 6 are presented instantaneous values of the current during the commutations, and specific moments of development of the transient processes for each of the six experiments.

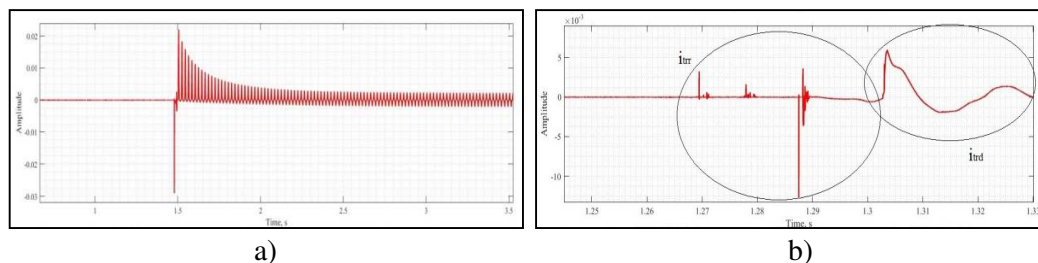

Figure 3: The moment of the switching the load Tr.AL1 on. Experiment №1(a). The both components of the  $i_{tr}(t)$ :  $i_{irr}(t)$  and  $i_{ird}(t)$  in the current timing diagram (b).

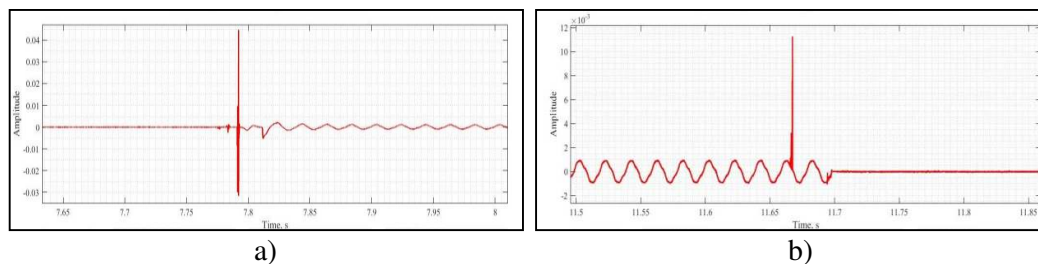

Figure 4: The moment of switching the load Tr.AL2 on (a) and off (b). Experiment №2

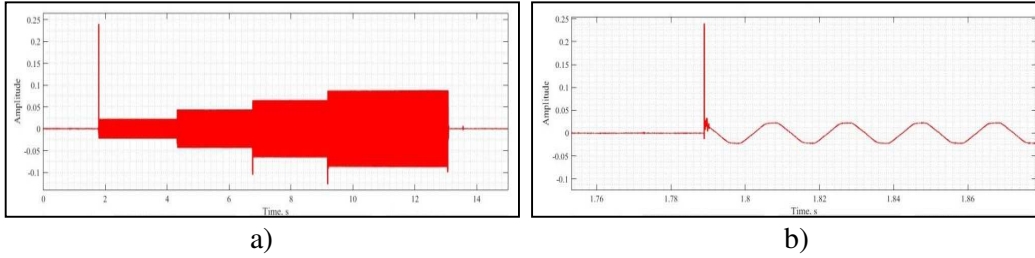

Figure 5: Transient process during the experiments № 3-5 (a); the moment of switching the load AL1 on experiment №3 (b).

The received data for the main parameters of the transient process are summarized in Table 4. The data show that the main parameters of the transient process are highly dependent on the type of the load, and much less from the length of the feeder. In all experiments in the current timing diagram is visible the appearance of the electric arc at the initial moment of commutation. It is expressed by a series of short duration pulses added to  $i_{st}(t)$  at the time before switching -  $i_{st}(-0)$  (Figure 3 b).

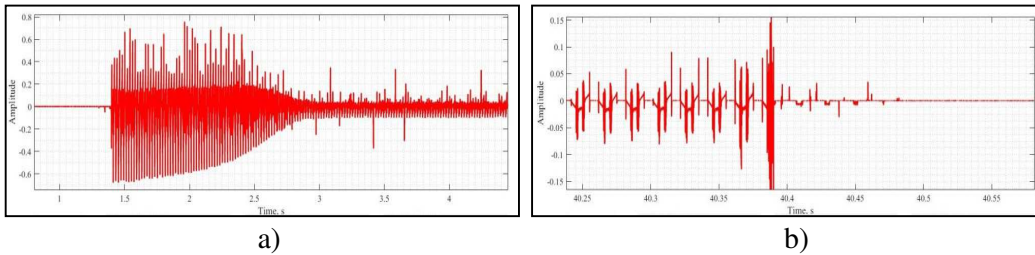

Figure 6: Switching the induction motor (IM) on - transient component (a) and switching the inductor motor off - the moment of commutation (b). Experiment №6

In the time domain are clearly visible both ingredients of the current transient component -  $i_{trr}(t)$  and  $i_{trd}(t)$ . Since the arc commutation is the nonlinear element connected in serial in the substitute diagram and its dynamically changing parameters, these local peaks actually are short, low-energy pulses before start of  $i_{tr}(t)$ .

Table 3: Summarized data for the main parameters of the transient process

№ exp.	$I_p/I_{MN}$	$D_I/I_{MN}$	$I_{Mtrd}/I_{MN}$	$\tau_1$	$\tau_2$	$\Delta\tau$
	-	-	-	ms	ms	ms
1 on	38.6	45.3	5	200	1000	15
1 off	81.6	93.3	-	-	40	5
2 on	32.1	54.3	6	10	66	20
2 off	13.2	13.2	-	-	31	3
3	10.7	10.7	-	-	1.5	1.5
4	2.65	2,65	-	-	2	2
5 on	1.9	1.9	-	-	2	2
5 off	1.15	1.15	-	-	30	2.5
6 on	14.8	31.16	14.5	1250	1500	2
6 off	16.4	23.4	-	-	-	2

Actually, taking into account the duration of the transient process by the timing diagram of the current for the origin could be considered the pulses generated by the arc and for the

end complete attenuation of  $i_{tr}(t)$ . These peaks vanish after establishment of the full contact between the working surfaces of the switching devices [6]. For the value of  $I_p$ ,  $I_{Mtrr}$  and  $\tau_2$  is essential the energy stored in the parts of the chain, which is determined by the self-inductance of the load and the transformer.  $I_{Mtrr}$  and  $\tau_1$  can be accurately indicated only in experiments № 1, 2 and 6 in the switching on mode, because then the transition process is more prolonged. In these cases, the reporting of these two parameters is impractical due to the highly distorted nature of stationary and transient components of the process. In other cases (exp. № 2, 3, 4 and 5),  $D_I$  coincides with the  $I_p$ , due to the rapid attenuation of  $i_{trd}(t)$  to the level of the rated current during the one period (Figure 5 b).

In experiments № 1, 2 and 6 (highly inductive nature of the load) transient processes last comparatively for long periods and  $\tau_2$  reaches values up to 1 – 1.5 s. When switching of the resistive loads (exp. № 3 - 5), this period is much shorter - about 30 ms. The most heavy mode for start-protecting equipment in terms of the duration of the transient process is switching the inductor motor (exp. № 6).

#### 4. CONCLUSION

Survey of the transient processes in the circuits supplied by transformers burden with loads with inductive and resistive character of the impedance, indicates that in practice often creates conditions for occurrence of commutation currents to the transient components whose amplitudes and duration in many cases exceed the nominal parameters of the switching and protective devices. This requires a special approach in the design of the power distribution systems, taking into account the basic parameters of the transient process, the length of feeders and type of load. Proper selection and point of commutation of the switching equipment and the installation of appropriate protective elements would prevent damage in the more sensitive consumers during unwanted switching operations. The results of measurements provide guidance about the possibilities and limitations of using DAQ systems in the study of complex processes in real physical models of electric power systems in the laboratory.

#### Acknowledgements

This paper is a results from project “Study of the electric power system stability and frequency control at a predominant share of renewable energy generation” grant DN07/27/15.12.2016 from the Bulgarian National Science Fund.

#### References

- [1] Gerasimov Kr., Kamenov Y., Modeling in the electrical power systems – lectures, Avangard Prima, Sofia 2007, ISBN 978-954-323-252-9.
- [2] Notov P., Gerasimov Kr., Transient processes in electrical power systems, TU-Sofia 1997, ISBN 954-438-205-4, 1997
- [3] Preve C., Protection of Electrical Networks, ISTE Ltd 2006, ISBN-13: 978-1-905209-06-4.
- [4] Nedelchev I., Zhivomirov H., Vasilev R. Processing of random signals, obtained by investigation of the plazma coating systems with LabView software, Proceedings of International Scientific Symposium Electrical Power Engineering 2014, pp. 143 - 147, ISBN: 978-954-20-0497-4, September 11 – September 13 2014.
- [5] Rangelov, Y., Marinov A., Nikolaev N., Measurement and data logging system for specialized high voltage equipment, SIELA 2016, 29 May -1 June 2016, Bourgas, Bulgaria. Proceedings of Digests, pp. 159-160, ISBN 978-619-160-648-1.
- [6] Gerasimov Kr., Gerasimov K., Short-circuits in electrical power systems, TU-Varna 2016, ISBN 978-954-20-0758-6.

# **PARTICLE COLLECTION EFFICIENCY ANALYSIS OF AN ELECTROSTATIC PRECIPITATOR**

Lizica-Simona Paraschiv<sup>1</sup>, Spiru Paraschiv  
“Dunarea de Jos” University of Galati

## **ABSTRACT**

Electrostatic precipitator is a highly efficient device for cleaning exhaust gases from industrial processes. The present numerical study implies the calculating of the collection efficiency of an electrostatic precipitator as a function of the electric field strength and particle migration velocity. There are also presented the effects of particle size changes on calculated collection efficiency.

## **1. INTRODUCTION**

Electrostatic Precipitators (EPS) have a wide use in various industries for pollution control. Although large investments are necessary compared to other gas cleaning methods, the cost of maintenance, high collection efficiency and the ability to operate under severe conditions make the ESP the best solution for dedusting gases in power plants, cement industry, steel industry and in the glass industry. The performance of electrostatic precipitators depends on the properties of particulate matter, especially resistivity and particle size.

The electrostatic precipitator works by applying energy to the particles that are collected without significantly affecting the gas flow.

The electrostatically charged particles in the gas stream are attracted and deposited on the collection plates. When enough particles have accumulated on the collection devices, they are shaken off by mechanical devices. The particles fall into a hopper at the bottom of the device where a conveyor system carries them away for disposal or recycling.

The most basic model of the precipitator consists of a row of thin vertical wires and a stack of large flat metal plates (Fig.1). The distance between plates varies between 1 and 18 cm, depending on the application. The gas flows between the vertical flat plates and over the wires. An electric charge of several thousand volts is applied between wires and plates to remove impurities from the gas stream.

## **2. PRINCIPLES OF ELECTROSTATIC PRECIPITATOR**

Electrostatic precipitation is a method of dust collecting using electrostatic forces and consists of discharge wires and vertical flat plate collectors. A high voltage is applied to the discharge wires to form an electric field between the wires and the collecting plates, which results in ionization of the gas. When the gas containing solid particles flows between the collecting plates and the discharge wires, the gas particles are charged with by the ions. The Coulomb force produced by the electric field determines the collection of ionized particles on the collecting plates, thus leading to gas purification (Fig. 2).

Electrostatic precipitators are important devices in the process of cleaning the flue gases. They are very effective in reducing particle pollution, removing particles whose diameter can

---

<sup>1</sup> scraciun@ugal.ro; Tel.: +40-766-255-759

be 0.01 microns. In addition, they can handle large volumes of gas at different temperatures and variable flow, removing solid particles or liquid droplets.

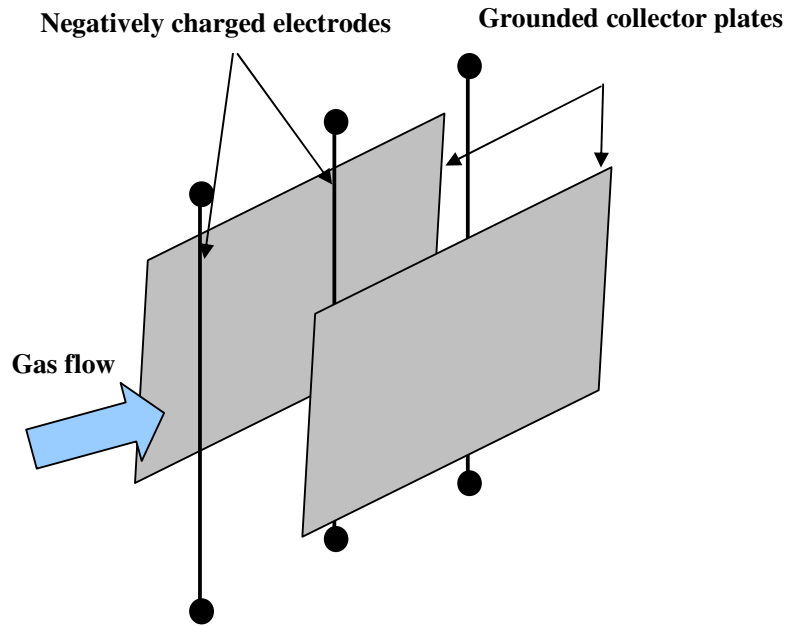

Figure 1: Schematic diagram of a wire-duct electrostatic precipitator

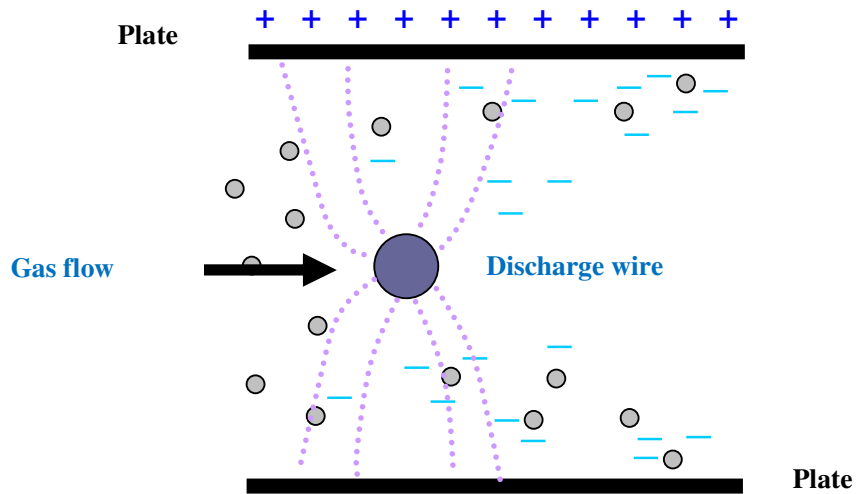

Figure 2: Schematic diagram of particle motion in electric field (top view)

The precipitator efficiency is calculated using the simplified version of the Deutsch equation is often applied:

$$\eta = 1 - \exp\left[-w_{eff} \frac{A}{\dot{V}}\right] \quad (1)$$

$w_{eff}$  – effective migration rate

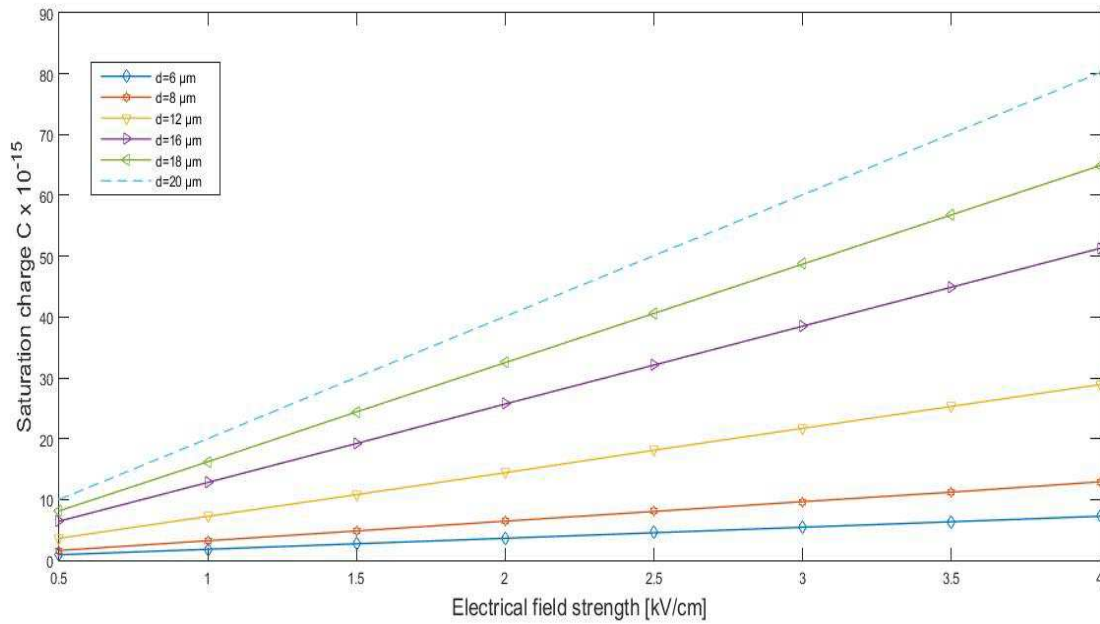

Figure 3: Saturation charge as a function of electrical field strength

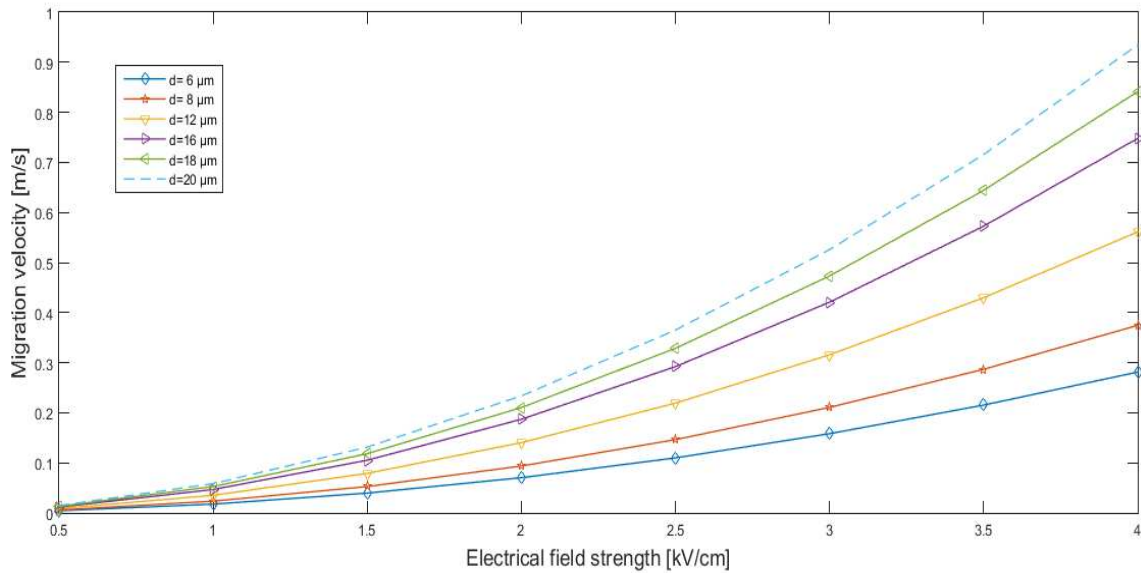

Figure 4: Migration velocities as a function of electrical field strength

The particle migration velocity is the most important parameter and is dependent on a large number of features, such as: electric field strength, particle diameter, gas viscosity and dust properties. The particle transport due to electric field strength is influenced by the particle velocity due to the electrostatic force:

$$w_t = \frac{Q \cdot E}{3\pi \cdot \eta \cdot d} \quad (2)$$

$w_t$  – theoretical migration velocity

$Q$  – saturation charge

$\eta$  - dynamic coefficient of gas viscosity

$$Q = \pi \epsilon_0 \left\{ \left( 1 + \frac{2\lambda}{d} \right) + \frac{2}{1 + \frac{2\lambda}{d}} \cdot \left( \frac{\epsilon - 1}{\epsilon + 2} \right) \right\} d^2 E \cdot \frac{t}{t + \tau} \quad (3)$$

$\lambda$  - particle free path in the medium  
 $\epsilon$  - dielectric coefficient of vacuum  
 $\epsilon_0$  - particle relative dielectric coefficient.

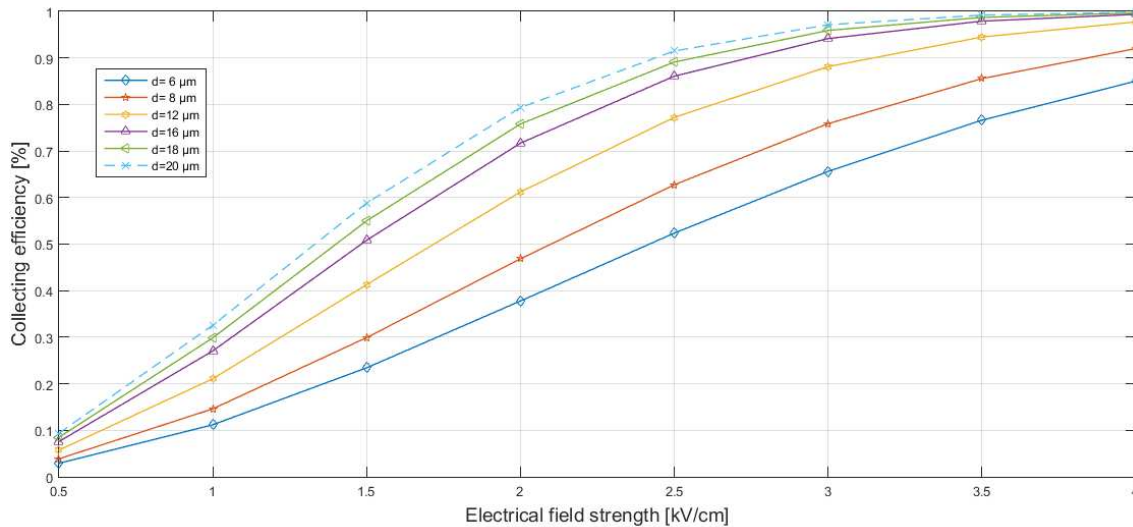

Figure 5: Collection efficiency as a function of electrical field strength

In Figure 5, efficiency vs corona field strength is plotted, and these calculated results were generated by varying the particles diameter from 6 to 20 mm, and the field strength 0.5 to 4 kV/cm, respectively.

### 3. CONCLUSIONS

Larger particles are removed more efficiently because they receive a higher electrical charge. In general, the efficiency of the EPS easily exceeds 90% for particles larger than 8 mm in diameter and for an electrical field strength of over 3.5 kV / cm.

The collection efficiency increases with the increase of the supply voltage of the discharge electrode but becomes constant for a given voltage level of about 4 kV / cm, for this specific case.

### References

- [1] Chang, C.-L., Bai, H., "Effects of Some Geometric Parameters on the Electrostatic Precipitator Efficiency at Different Operation Indexes", *Aerosol Science and Technology*, 33:3, 228-238, DOI: 10.1080/027868200416222
- [2] Popa, G. N., Popa, I., Deaconu, S. I., "Collecting efficiencies and migration velocities of dust particles from a three sections electrostatic precipitator", *Annals of faculty engineering Hunedoara – International Journal of Engineering*, X, 2012.
- [3] Dixkens, J., Fissan, H., "Development of an Electrostatic Precipitator for Off-Line Particle Analysis", *Aerosol Science & Technology*, 30:5, 438-453, DOI: 10.1080/027868299304480
- [4] Gajbhiye, N., Eswaran, V., Saha, A. K., Kumar, A., "Numerical calculation of particle collection efficiency in an electrostatic precipitator", *Sadhana*, Vol. 40, Part 3, May 2015, pp. 863–873.
- [5] Falaguasta, M. C. R., Steffens, J., Valdes, E. E., COURY, J. R., "Overall collection efficiency of a plate-wire electrostatic precipitator operating on the removal of PM2.5." *Lat. Am. appl. res.*, 2008, vol.38, pp. 179-186.

# MODELLING AND CONTROL OF A DC MOTOR

Catalina Alexandra Sima<sup>1</sup>, George Cristian Lazaroiu<sup>1,2</sup>,  
Virgil Dumbrava<sup>1</sup>, Mihai Tirsu<sup>3</sup>, Victor Galbura<sup>3</sup>

<sup>1</sup>University POLITEHNICA of Bucharest, Romania

<sup>2</sup>University MARITIMA of Constanta, Constanta, Romania

<sup>3</sup>Institute of Power Engineering, Academy of Sciences of Moldova, Moldova

## ABSTRACT

In this paper, the modelling and control of a DC motor using MATLAB software (Simulink and SISO Design Tool) is carried on. The Simulink environment is used for modeling the motor and SISO Design Tool is used for controlling the motor by automate tuning of the controllers. The tuned controllers are PI (Proportional-Integral), PD (Proportional-Derivative) and PID (Proportional-Integral- Derivative). The controllers need to be tuned for improving the performance of a system and designing the controller requires system mathematical modeling.

## 1. INTRODUCTION

A DC motor is a rotary electrical machine that converts direct current into mechanical energy, being the first type widely used as are powered from existing DC distribution systems. The speed of a DC motor can be controlled by means of a variable supply voltage or by modifying the magnitude of the winding current. It is important to control the considered motor by choosing the suitable type of the controller and tune it properly in order to increase the system's performance. In this paper, for controlling the DC motor, two cases are considered: first one is where motor's inductance is neglected and the resulted function is a 1st order function, while the second one is where the motor's inductance is not neglected and the resulted function is a 2<sup>nd</sup> order one. In order to be able to design the controller it is necessary to model the system first. In this paper, the modeling and control of a DC motor is described. The electric circuit of the DC motor is presented in Fig. 1. The battery is represented by a voltage source with voltage  $V_s$ .

There are many types of controllers that can be used for controlling the desired system. It is important to be able to choose the type that provides the best performance of the considered system. In this paper, three controllers are considered, PI (proportional-integral), PD (proportional-derivative) and PID (proportional-integral-derivative). These controllers are simple and popular for industrial applications and for SISO systems. The tuning process represents the adjustment of the controller's parameters (gains  $K_P$ ,  $K_I$  and  $K_D$ ) in order to satisfy the analyzed motor, each gain is corresponding to each type of the considered controllers. By the increasing of the proportional gain  $K_P$  the rise time is modifying and with the increase of the integral gain  $K_I$  the steady-state error is smaller but the overshoot is increasing. The derivative gain  $K_D$  is improving the dynamic component (the overshoot and the settling time), but it introduces a large steady-state error. It can be noticed that by combining the effects of components P, I and D the system shows superior performances in both steady-state and transient regimes. It is known that for obtaining an increasing performance of the system, to use a PID controller is recommended [1-3].

Simulink environment and SISO Design Tool from MATLAB software are used for modeling and controlling of the motor. Simulink is a graphical environment for modeling, simulating and analyzing systems. SISO Design Tool is an application in which is possible to



design and analyze single-input, single-output controllers using graphical and automated tuning models. The equations that characterize the function of the DC motor will be described in the following [5-7].

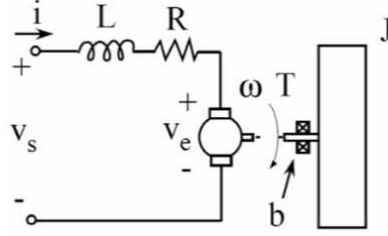

Figure 1: Electric circuit that describes the DC motor

## 2. MODELLING AND CONTROL

Starting with the scheme illustrated in Fig. 1, the DC motor model is determined as the following:

- expression of the motion (Electrical) - Kirchhoff's Law:

$$V_s - V_L - V_R - V_e = 0 \Rightarrow V_s - L \frac{di}{dt} - RI - K_B \omega = 0 \quad (1)$$

where  $V_e$  – back electromotive force (back-emf);  $V_L$  – voltage at inductor's terminals;  $V_R$  – voltage at resistor's terminals;  $V_s$  – voltage source;  $L$  – inductance;  $R$  – resistance;  $I$  – current through the DC motor;  $K_B$  – back-emf constant;  $\omega$  – angular velocity in time-domain.

- expression of motion (Mechanical) – Torque Balance:

$$T = T_b + T_j \Rightarrow K_T I - b\omega = J \frac{d\omega}{dt} \quad (2)$$

where  $T$  – torque;  $T_b$  – motor bearings torque;  $T_j$  – load torque;  $K_T$  – torque constant;  $b$  – dissipation (viscous friction in motor bearings);  $J$  – moment of inertia.

- Thus, the combined equations of motion are:

$$\begin{cases} L \frac{di}{dt} + RI + K_B \omega = V_s \\ J \frac{d\omega}{dt} + b\omega = K_T I \end{cases} \quad (3)$$

- Hence:

$$\begin{cases} V_s(s) - V_L(s) - V_R(s) - V_e(s) = 0 \\ V_s(s) - LsI(s) - RI(s) - K_B \Omega(s) = 0 \end{cases} \quad (4)$$

where  $s$  – Laplace operator;  $\Omega$  – angular velocity in s-domain.

The equation of motion (Mechanical) – Torque Balance is:

$$\begin{cases} T(s) = T_b(s) + T_j(s) \\ K_T I(s) - b\Omega(s) = Js\Omega(s) \end{cases} \quad (5)$$

Thus, the combined equations of motion are:

$$\begin{cases} LsI(s) + RI(s) + K_B \Omega(s) = V_s(s) \\ Js\Omega(s) + b\Omega(s) = K_T I(s) \end{cases} \Rightarrow \left[ \frac{LJ}{R} \cdot s^2 + \left( \frac{Lb}{R} + J \right) \cdot s + \left( b + \frac{K_T K_B}{R} \right) \right] \Omega(s) = \frac{K_T}{R} V_s(s) \quad (6)$$

$$(J_s + b) \cdot \Omega(s) = K_T I(s)$$

By neglecting the impedance can be obtained:

$$L \approx 0 \Rightarrow \left[ J \cdot s + \left( b + \frac{K_T K_B}{R} \right) \right] \Omega(s) = \frac{K_T}{R} V_s(s) \quad (7)$$

Without neglecting the impedance, we obtain:

$$\begin{cases} \frac{\Omega(s)}{V_s(s)} = \frac{\frac{K_T}{LJ}}{s^2 + \left(\frac{b}{J} + \frac{R}{L}\right) \cdot s + \frac{bR + K_T K_B}{LJ}} \\ \frac{I(s)}{V_s(s)} = \frac{\frac{1}{R} \cdot \left(s + \frac{b}{J}\right)}{s^2 + \left(\frac{b}{J} + \frac{R}{L}\right) \cdot s + \left(\frac{bR + K_T K_B}{LJ}\right)} \end{cases} \quad (8)$$

Considering the above model, a DC motor is modelled using MATLAB and Simulink software. It is considered that the initial conditions are 0, thus there is no current through the motor at the starting point and the load is not spinning instantly. The frictions are neglected and considering (3), the model that describes the motor is [4]:

$$I(t) = \int \frac{1}{L} \cdot [V_s - R \cdot I(t) - K_B \cdot \omega(t)] \text{ and } \omega(t) = \int \frac{K_T}{J} \cdot I(t) \quad (9)$$

In Simulink, it is necessary to add two integer elements that represent the integrals in the (9). The output of one of the integer element is angular velocity, and the other output of the exit is the current. The block scheme that is represented in Simulink is shown in Fig. 2. The part of the block scheme that represents the second equation will have the input  $\omega$  and the output  $K_T/J \cdot I(t)$ . For the integer that has the output the current, the input is  $V_s - R \cdot I(t) - K_B \cdot \omega(t)$ . In order to represent the source voltage in Simulink a step signal is used and for the other two terms “Gain” element is used. The all three inputs will be summed using „Add” element.

The data for the DC motor:

$$K_T = 6 \left[ \frac{N \cdot m}{A} \right], K_B = 6 \left[ \frac{V}{rad/s} \right], R = 6 [\Omega], L = 6[H], J = 2[kgm^2], \frac{K_T}{J} = 3.$$

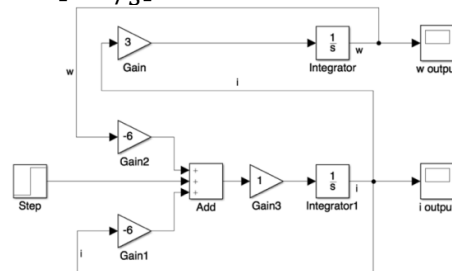

Figure 2: Block scheme of the DC motor

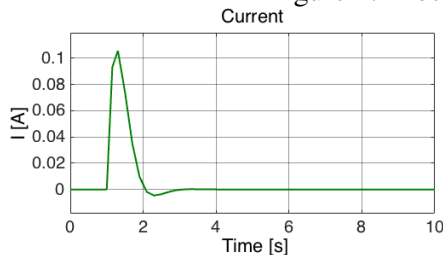

Figure 3: Current through the motor

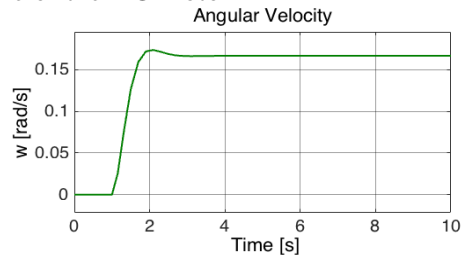

Figure 4: Angular velocity

Accessing “Scope” element, the current and angular velocity can be observed and Fig. 3 and 4 result. In Fig. 3 it can be seen the variation of the current after applying the step signal. The magnitude of the current is increasing due to the value of the torque that imposes the load to spin. The current decreases to the starting point 0, due to the applied voltage to the coil that tends to 0. In Fig. 4 it can be seen that the angular velocity  $\omega$  starts increasing and then remains at a constant value. This is a DC motor characteristic. Once the load is starting to spin faster, the back e.m.f. is increasing and the voltage applied to the motor and coils is

decreasing. The angular velocity reach a steady state value when the voltage applied to the coil is 0 and the back e.m.f. is big enough. The current is 0 due to the fact that the voltage through the coils is 0. This is an ideal model and the friction is not modelled, thus the load will not continue to spin like it's happening to a real model. In this case, the value of the angular velocity will decrease and the value of the current won't be 0. The value will be high enough in order to overcome the friction, in this case the friction is neglected so the current is 0, due to the fact that the once the motor is rotating it is not necessary to add extra energy to maintain the motor rotating.

For the control of the DC motor it is used "SISO Design Tool" from MATLAB software. This tool can automatically tune the considered controllers of the DC motor. It is considered a closed-loop for designing the controllers. The value that is controlled is the motor speed. The DC motor will be represented by a transfer function that describes a mathematical view of the inputs and outputs of a DC motor and the way they influence each other. The input of the system is the voltage source and the output of the system is angular velocity.

From (7) results the first order transfer function of the DC motor with the impedance and friction neglected and the second order function of the DC motor where only the friction is neglected:

$$\frac{\Omega(s)}{V_s(s)} = \frac{K_T}{JRs + K_T \cdot K_B}$$

$$\frac{\Omega(s)}{V_s(s)} = \frac{\frac{K_T}{LJ}}{s^2 + s\frac{R}{L} + \frac{K_T \cdot K_B}{LJ}} \quad (10)$$

Three types of controllers are simulated. The controllers were tuned automatically with the help of „SISO Design Tool" from MATLAB software. The admissible bandwidth is considered  $\pm 10\%y_{st}$ . In the analyzed cases  $y_{st} = 1$ .

The overshoot and steady-state error are computed with:

$$\sigma = \left| \frac{y_{st} - y_{max}}{y_{st}} \right| \cdot 100 [\%]$$

$$\varepsilon_{st} = \left| \frac{y_{ref} - y_{st}}{y_{ref}} \right| \cdot 100 [\%] \quad (11)$$

where  $y_{max}$  – the maximum value of the output signal;  $y_{st}$  – steady state output signal;  $\sigma$  – overshoot;  $\varepsilon_{st}$  – steady-state error.

In the following PI, PD and PID controllers are automatically tuned with „SISO Design Tool". Table 1 reports the controller's characteristics. Analyzing Figs. 5-8 and Table 2, it can be seen that the PID controller provides the best system response. PD controller provides the smallest settling time ( $t_t$ ) and overshoot but the steady-state error is not 0. Regarding these aspects, PID controller is recommended for controlling a DC motor due to the fact that it is characterized by the smallest values for the settling time and overshoot, also with no steady-state error.

Table 1: Controller characteristics

Controller	$K_P$	$K_I$	$K_D$	Transfer Function
PI	6,20	56,31	-	$H(s) = 56,31 \cdot \frac{1 + 0,11s}{s}$
PD	425,56	-	0	$H(s) = 425,46$
PID	8,03	48,1	-0,09	$H(s) = 48,124 \cdot \frac{(1 + 0,068s) \cdot (1 + 0,19s)}{s(1 + 0,088s)}$

The results of the simulation considering the first order function are illustrated in Figs. 5-8.

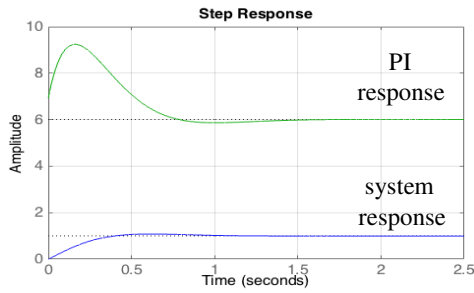

Figure 5: The response to step command with PI tuned controller

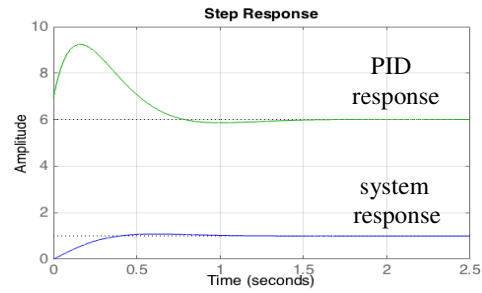

Figure 6: The response to step command with PID tuned controller

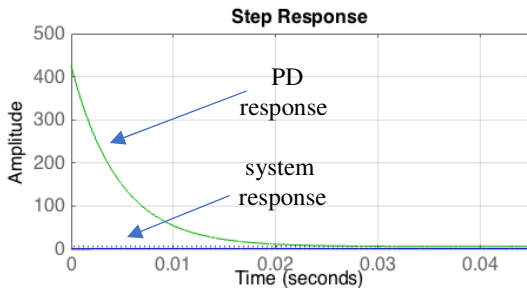

Figure 7: The response to step command with PD tuned controller

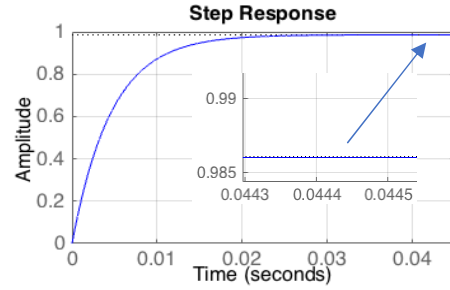

Figure 8: The system response to step command with PD tuned controller

Table 2: System performance

Controller	$\varepsilon_{st}[\%]$	$t_t [s]$	$\sigma[\%]$	$y_{max}$	$y_{ref}$	$y_{st}$
PI	0	0,76	13,8	1,138	1	1
PD	1,4	0,01119	0	0,986	1	0,986
PID	0	0,32	7,83	1,0783	1	1

The results of the simulation considering the second order function are illustrated in Figs. 9-11.

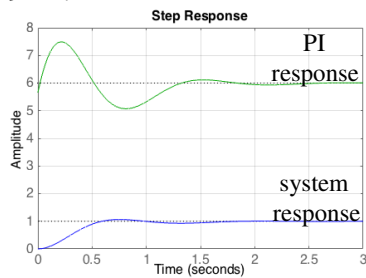

Figure 9: The response to step command with PI tuned controller

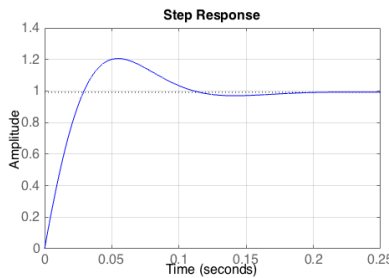

Figure 10: The system response to step command with PD tuned controller

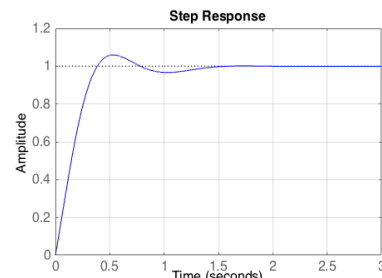

Figure 11: The system response to step command with PID tuned controller

It can be seen that the PID controller provides the most performing system response also for the second order function. The gains values are different due to the order of the transfer function. Table 3 reports the characteristics of the tuned controllers and Table 4 provides the system performance. Analyzing Figs. 9-11 and Table 4, it can be seen that the PID controller provides the best system response. PID controller has no steady-state error and the smallest settling time. The smallest overshoot is provided by the PI controller, but it has a bigger

settling time compared to the PID controller. Regarding these aspects, the PID controller determines the best system response.

Table 3: Controller characteristics

Controller	$K_p$	$K_I$	$K_D$	Transfer Function
PI	5,66	18,285	-	$H(s) = 18,285 \cdot \frac{1 + 0,31s}{s}$
PD	667,96	-	16,03	$H(s) = 667,96 \cdot \frac{1 + 0,024s}{1}$
PID	12,9	38	1,09	$H(s) = 38,021 \cdot \frac{(1 + 0,34s + (0,17s)^2)}{s}$

Table 4: System performance

Controller	$\varepsilon_{st}[\%]$	$t_t [s]$	$\sigma[\%]$	$y_{max}$	$y_{ref}$	$y_{st}$
PI	0	0,5	6,35	1,0635	1	1
PD	0	0,0245	20,6	1,206	1	1
PID	0	0,3073	7,83	1,06	1	1

### 3. CONCLUSIONS

For improving the system performance, it is necessary to consider the type of the controller and its tuning. For a DC motor the suited type of the controller is the PID one due to the performant system response. The stability of the system is observed through the figures resulted from the simulation. Before it is possible to consider the control of the system it is necessary to model it. In this paper, the modelling and the control of a DC motor are presented. The friction is neglected and two types of transfer functions that describe the motor are considered. The first one is a 1st order one where the inductance is neglected, and the second one is 2nd order one where the inductance is not neglected. Considering the inductance, the model is becoming more complex and the response of the system is more accurate and improved, but the resulted type of the controller is the same, the PID controller.

#### Acknowledgement

This work was supported in part by a grant of the Romanian Ministry of Research and Innovation, CCCDI – UEFISCDI, project number PN-III-P1-1.2-PCCDI-2017-0404/31PCCD/2018, within PNCDI III and 37BMPNIII-P3-199/02.09.2016.

#### References

- [1] Ababei, S., Systems theory and automation elements (in Romanian: *Teoria sistemelor si elemente de reglaj automat*, Publishing House TEHNICA-INFO, Chisinau, 2006.
- [2] Voicu, M., Analysis techniques of automation systems (in Romanian: *Tehnici de analiza a stabilitatii sistemelor automate*), Publishing House TEHNICA, Bucharest, 1986.
- [3] \*\*\* Fixed structure controllers P, PI, PD, <https://www.scribd.com/doc/124897696/Teoria-sistemelor-de-reglare-automata-regulatoare-PI-si-PID>
- [4] Hover, F., Gossard, D., Barbastathis, G., Dynamics and Control II, <https://ocw.mit.edu/courses/mechanical-engineering/2-004-systems-modeling-and-control-ii-fall-2007/>
- [5] Balestrino, A., Crisostomi, E., *Advanced PID controllers in MIMO systems, Power Electronics Electrical Drives Automation and Motion (SPEEDAM)*, August, 2010.
- [6] Osorio, L., Mendes, J., Araujo, R., Matias, T., *A comparison of adaptive PID methodologies controlling a DC motor with a varying load*, October, 2013.
- [7] Naung, Y., Schagin, A., Oo, H. L., Ye, K. Z., Khaing, Z. M., *Implementation of data driven control system of DC motor by using system identification process*, IEEE Conference of Russian Young Researchers in Electrical and Electronic Engineering (EIConRus), Moscow and St. Petersburg, 2018.

# CONSTRUCTION LOG BOOK – A WEB-BASED APPLICATION THAT SUPPORTS A BUILDING ON ITS ENTIRE LIFE-CYCLE

Ioana Udrea<sup>\*1</sup>, Valeru Kraus<sup>2</sup>

<sup>1,2</sup>ASC-Romania, 9 Stefan Marinescu Street, District 6, 060121, Bucharest, Romania

## ABSTRACT

According to the Romanian legislation, Construction Log Book (CLB) contains, in a standardized form, information related to the entire life-cycle of a building. This paper presents a web-based application designed to improve CLB document management. For each specific CLB project, the system proposes a standardized structure of documents with mandatory and optional entries. Legislative references and a synthesis of them (necessary documents, completion forms, standard forms) are given for various types of documents. The documents are indexed according to many attributes and a complex search system is developed. Based on a requirement study, a concept model of information flow in Acceptance upon Work Completion and Final Acceptance was developed.

CLB sustains construction projects on entire building life cycle and in all construction phases. It realized an intelligent structure of documents that could be useful to architects, engineers, constructors, building developers, owners of buildings and others. Similar documents could be compared easily and application generated reports related to different CLB projects. Also, the data included in CLB could be the necessary information for development of Building Information Models (BIM).

## 1. INTRODUCTION

In the last years an increase of informatization in knowledge management in construction industry can be noticed [1]. In the past there has been no structured approach to learning from construction projects once they are completed. In [2] Tupenaite declares that the importance of information management in construction fields is observed in development of Web-based distributed document management applications. In [3] authors present a business case in the construction sector, where they have designed and prototyped an innovative Web-based distributed document management application. They opened the document management services to other information systems, especially the ones used internally by some of their partners. Another research [4] presents a web database for document management in small and medium-sized enterprises of the construction sector in Spain. A survey was conducted to define the rules on how to organize all the information related to a project. In the end, a concept model of information flow was developed and implemented in a web-based tool, designed according to current standards and theories of classification and organization of information related to construction.

Concerning the need of centralized database related to Romanian construction industry, there is a need for developing an integrated management system for Construction Log Book.

The new Romanian Legislation, “Regulation Related to Construction Reception”, enforce as of 2017 [5] and approved by [6], specifies that for new constructed building and for all existing buildings (after January 2018), CLB must exist and be done in accordance with the new Regulation. For this purpose, we developed a Web-based application that responds to this need.

---

\* Corresponding author: PhD. Ioana Udrea Tel.: +040 744 661303  
E-mail address: ioana.udrea@asc-ro.com

## 2. METHOD

### 2.1. Construction Log Book Description

CLB consists of all documents relating to a construction and supports it on the entire life cycle. It is structured in four chapters, CAP A: Design documents, CAP B: Execution of construction documents, CAP C: Documents related to the reception procedure; CAP D: Documents on exploitation, maintenance, repair, tracking of technical behaviour in time and post-use of the construction [5]. Because in “Regulation Related to Construction Reception” a summarize description of CLB content is presented [5] but a new Guide to CBL realization is not ready yet, we can refer to [7] as a detailed structure of CLB. It consists of a hierarchic structure of capitols, with more levels of subchapters, and documents that can be found at each book’s level.

In order to see an exact content of each subchapter of CLB, other Romanian rules and norms were studied. For example, to see what all the documents related to Building Permit are, we will refer to Methodological Norms related to Building Permit [8] and to the Law related to urbanism [9-10]. For ISU (*Inspectoratul pentru Situatii de Urgenta*, Inspectorate for Energy Situations) documentation we refer to [11-12], for (*Devizul General*, Construction General Estimation) the legislative acts mention in [14-15] were studied. Overall used norms are related to quality in constructions field [16-17] and to constructions importance categories [18-19].

### 2.2. Application Description

Following the CLB structure established by Romanian legislation [5-6], we developed *Construction Log Book* application. Using it, any kind of documents can be managed, not only documents specific to the Construction Log Book.

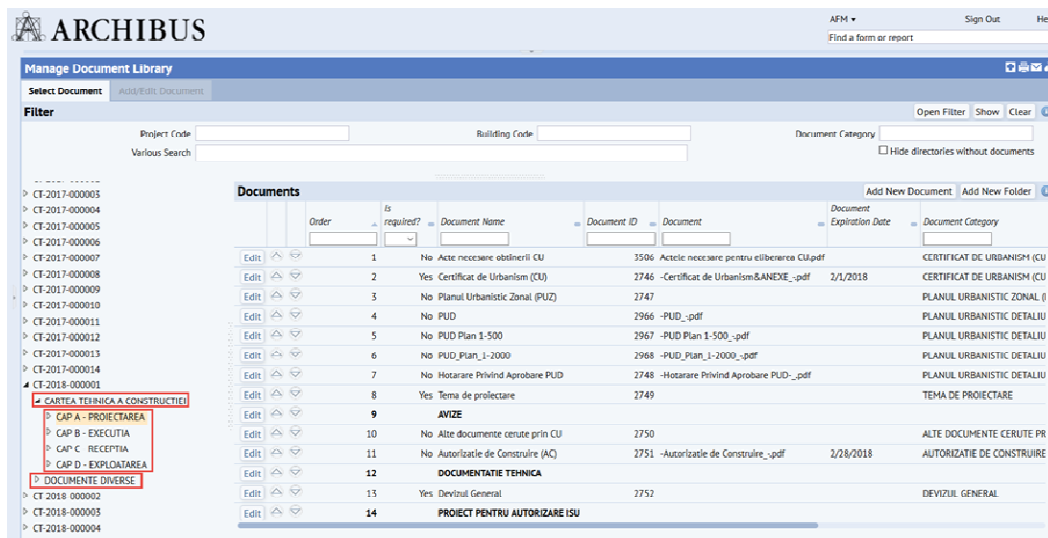

Fig. 1 Construction Log Book structure

In figure 1 it is presented the hierarchic structure of a Construction Log Book. You can see here the hierarchical (tree structure) of folders and documents. There are all the specific chapters of the *Construction Log Book*: CAP. A – PROIECTAREA, CAP. B – EXECUTIA,

CAP. C – RECEPTIA, CAP. D – EXPLOATAREA. And also, here, in *DOCUMENTE DIVERSE* folder, we can get various documents non-included in *Construction Log Book*. *Construction Log Book* documents are ordered according to the Romanian legislation [5-6]. In figure 2 one can see how a file attached to a document located in chapter A of CLB is opened with its associated app. The document shown in figure is *Plan Urbanistic Detaliat (PUD)* drawing, scale 1:500.

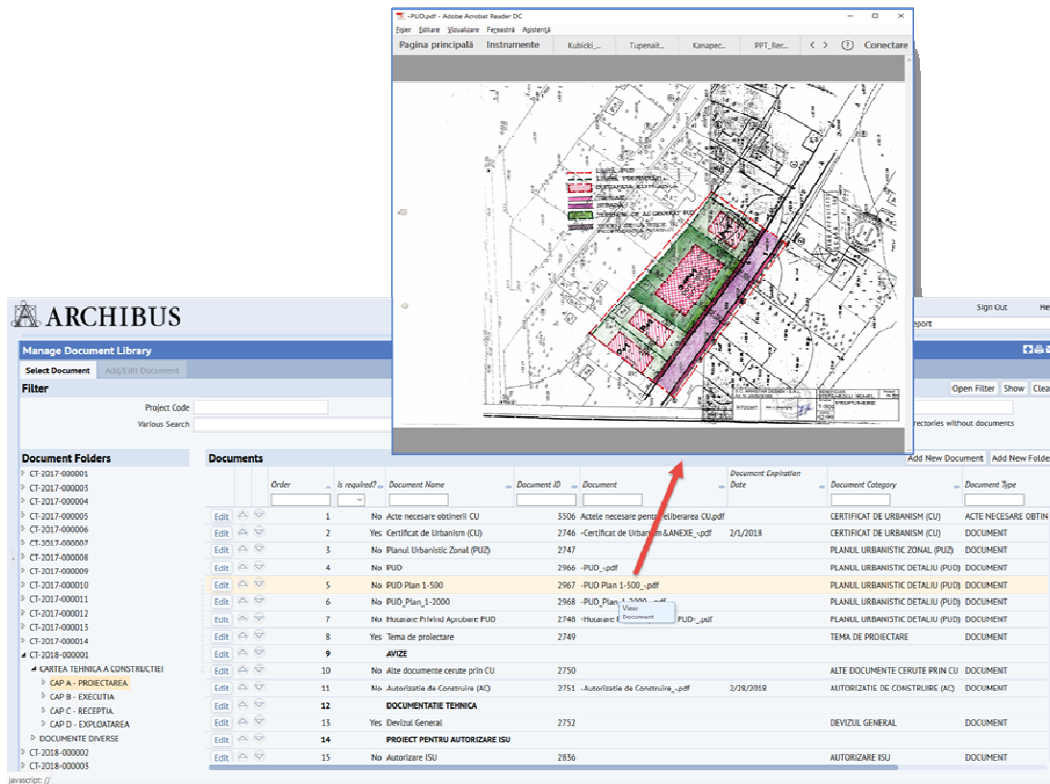

Fig. 2 Opening a file attached to a document in *Construction Log Book*

Each document is indexed using many attributes. In *Documents* panel, in correspondence with each document, there is *Edit* button. It opens, as you can see in figure 3, *Document Details*.

There are some compulsory fields, as *Document Category* and *Document Name*. We can mention, also, fields like *Document Author*, *Document Type* and *Project Code*.

Selecting the icon located near the *Document* field, we can open the file uploaded in the application. The file could be opened, as it was presented in figure 2, from the documents list of a CLB chapter and from many other places in the application.

Most of the documents contain information like *Document Number* and *Date Document*. Some documents have or may result *Document Expiration Date* information. An attribute is *Building Life Cycle Phase* when document was issued: *Autorizarea*, *Executia constructiei*, *Receptia la terminarea lucrarilor* and others.

Other information is related to the fact that a document could be signed or not. For example a “dwg“ file is a kind of only-digital document that cannot be signed.

In *Construction Log Book* structure, a document may or may not be mandatory. For example, *Building Permit* must be present in all *Construction Log Books*. This attribute is useful in check lists to see if all mandatory documents have files uploaded.



Besides mandatory, the order of a document in *Construction Log Book*, according to legislation, may be established. For this purpose, *Is Fixed?* attribute was created, it determines if a document is fixed or not (can or cannot be moved in file and subfolder structure of a folder).

All of these documents attributes can be seen in figure 3.

The screenshot shows the 'Manage Document Library' window in ARCHIBUS. The 'Document Details' section contains the following information:

- Document ID: 2746
- Document Name: Certificat de Urbanism (CU)
- Document Category: CERTIFICAT DE URBANISM (CU)
- Document Type: DOCUMENT
- Project Code: CT-2018-000901
- Document Author: Primaria Sect. 6 Man Bucuresti
- Directory Path: CT-2018-00001\CARTEA TEHNICA A CONSTRUCTIEI\CAP A - PROIECTAREA
- Description: Certificat de Urbanism (CU) - doc
- Document Number: 317/15A
- Date Document: 3/2/2004
- Document Expiration Date: 2/1/2018
- Is renewable?: Yes
- Is signed?: Signed
- Is original?: Original
- Building Life Cycle Phase: Autorizarea
- Action Item ID: (empty)
- This document is mandatory?: Yes
- Conditions required: Order 2
- Is fixed?: Yes

The 'Useful Informations' section shows a table of related documents:

Document ID	Document Name	Document	Document Category	Document Type
3504	Acte necesare abilitarii CU	Actele necesare pentru eliberarea CU.pdf	CERTIFICAT DE URBANISM (CU)	ACTE NECESARE OBTINERE
3505	Cerere pentru emitere CU	Formular Cerere emitere CU.pdf	CERTIFICAT DE URBANISM (CU)	FORMULAR
3507	Model completare Cerere Emitere CU	Model completare Cerere Emitere CU.pdf	CERTIFICAT DE URBANISM (CU)	MODEL

Fig. 3 Document details window

### 3. APPLICATION REPORTS AND DISCUSSIONS

Some documents have an expiration date. According to this information in the application alerts for any document categories can be defined.

In figure 4 various alerts for documents that expire after the current date in a number of days (corresponding to an interval related to a colour) or for documents that are already expired can be observed. You can see that for an Urbanistic Certificate, the validity period is of 12 months.

Different kinds of alerts can be defined in a specific task. Here the day-interval related to current date in which the alert is active, a colour and other attribute for the respective alert must be specified. In this task are also established the application roles or email addresses to notify when the alerts become active.

As can be seen from the figure 5, the application helps us to see a check list with mandatory documents that don't have any attached file in the application. There are two predefined lists of documents: *DOCUMENTE NECESARE RECEPTIEI FINALE* (documents required for Acceptance upon Completion) and *DOCUMENTE NECESARE RECEPTIEI LA TERMINAREA LUCRARILOR* (documents required for Final Reception) but any kind of list could be defined by the user.

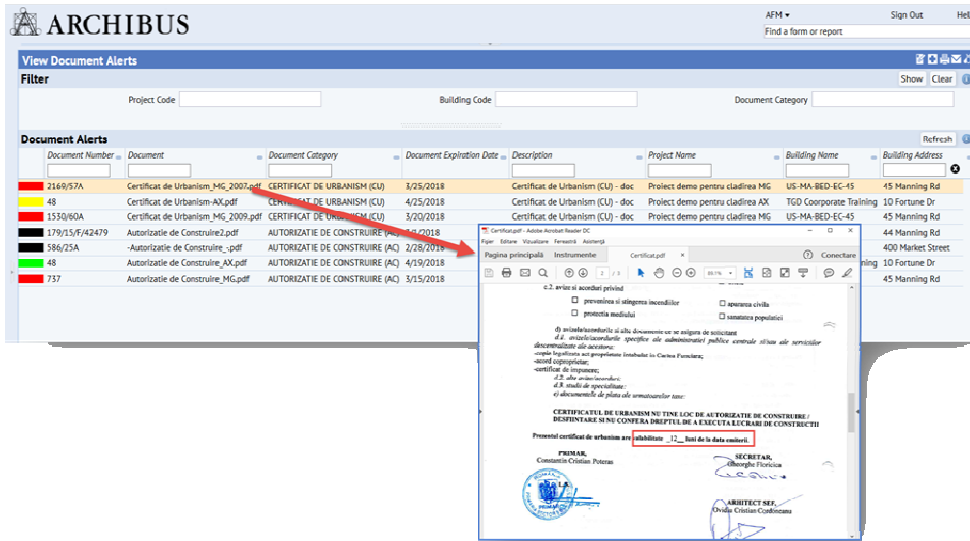





Fig. 4 Alerts for two different types of document categories

First of all, a project must be chosen and after that a list must be selected. In *Document Checklist* panel appears the desired list with all of the selected project documents, highlighted if the respective document has a file attached and is mandatory and red highlighted according to table 1 colour definition.

Table 1 Colour list corresponding to different kind of records

Colour	Sinification
	Mandatory documents with attached file
	Mandatory documents without attached file
	Not mandatory documents

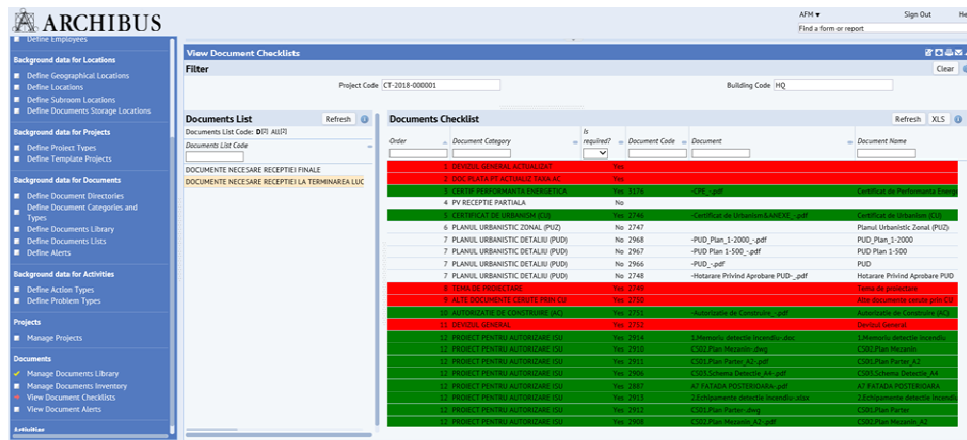

Fig. 5 Documents checklist window

### 3. CONCLUSIONS

In this paper a Web-based application which meets the requirements of Construction Log Book according to Romanian Legislation was developed. It supports construction projects on entire building life cycle and in all construction phases. It is not only a document repository that could be consulted by the factors which are related to the construction, but CLB is an intelligent application that can help the users see alerts about documents expiration. It could also be used to check the existence of receptions required documents. It has a flexible structure that allows its administrators to adapt the application to business requirements.

The documents are indexed according to many arguments and the application is provided with complex search and filtering facilities, allowing quick access to various information.

Also, CLB contain the necessary information for development of Building Information Models (BIM) and could be integrated to a BIM.

In future research, the developed application could be extended as an on-cloud application.

### References

- [1] Kanapeckiene L., Kaklauskas A., Zavadskas E. K., Seniut M., *Integrated Knowledge Management Model and System for Construction Projects*, Engineering Applications of Artificial Intelligence 23 (2010) 1200–1215
- [2] Tupenaite L., Kanapeckiene, L., Naimaviciene J., Knowledge Management Model for Construction Projects, The 8th International Conference “RELIABILITY and STATISTICS in TRANSPORTATION and COMMUNICATION - 2008”
- [3] Kubicki S., Dubois E., Halin G., Guerriero A. (2009) *Towards a Sustainable Services Innovation in the Construction Sector*. In: van Eck P., Gordijn J., Wieringa R. (eds) *Advanced Information Systems Engineering. CAiSE 2009. Lecture Notes in Computer Science*, vol 5565. Springer, Berlin, Heidelberg
- [4] Forcada, N., Casals, M., Roca, X., Gangoellis, M. *Adoption of web databases for document management in SMEs of the construction sector in Spain*. "Automation in construction", Juliol 2007, vol. 16, núm. 4, p. 411-424.
- [5] Regulamentul privind recepția construcțiilor (Regulation Related to Construction Reception), published in MO, Part I no. 406 - 30/05/2017 (annex to HG no. 343/2017);
- [6] Hotărârea nr. 343/2017 pentru modificarea Hotărârii Guvernului nr. 273/1994 privind aprobarea Regulamentului de recepție a lucrărilor de construcții și instalații aferente acestora, publicata in MO, Partea I nr. 406 din 30/05/2017
- [7] (2004), Ghid pentru intocmirea Cartii Tehnice a Constructiei (Guide for drawing up the Construction Log Book), Revised Edition, SC COCC-SA, 2004
- [8] Ordinul Ministerului Dezvoltării Regionale și Locuinței nr. 839/2009 pentru aprobarea Normelor metodologice de aplicare a Legii nr. 50/1991 privind autorizarea lucrărilor de construcții
- [9] Legea nr. 221/2011 pentru modificarea alin. (2) al art. 29 din Legea nr. 350/2001 privind amenajarea teritoriului și urbanismul
- [10] Norme Metodologice din 26 februarie 2016 de aplicare a Legii nr. 350/2001 privind amenajarea teritoriului și urbanismul și de elaborare și actualizare a documentațiilor de urbanism
- [11] Hotarare nr. 1739 din 6 decembrie 2006 pentru aprobarea categoriilor de constructii care se supun avizarii si/sau autorizarii privind securitatea la incendiu.
- [12] Hotărârea Guvernului nr. 571/2016 pentru aprobarea categoriilor de construcții și amenajări care se supun avizării și/sau autorizării privind securitatea la incendiu
- [13] Legea nr. 307/2006 privind apararea impotriva incendiilor, publicata in MO nr. 633 din 21 iulie 2006
- [14] Hotararea de Guvern nr. 28/2008 privind aprobarea continutului-cadru al documentatiei tehnico-economice aferente investitiilor publice precum si a structurii si metodologiei de elaborare a devizului general pentru obiective de investitii si lucrari de interventii
- [15] Hotarare nr. 44 din 22 ianuarie 2004 pentru aprobarea Normelor metodologice de aplicare a Legii nr. 571/2003 privind Codul fiscal
- [16] Legea nr. 163/2016 pentru modificarea și completarea Legii nr. 10/1995 privind calitatea în construcții, publicata in MO, Partea I, nr. 561 din 25 iulie 2016
- [17] Legea nr. 177/2015 pentru modificarea și completarea Legii nr. 10/1995 privind calitatea in constructii, publicata in MO nr. 484/2.07.2015;
- [18] HG 766, an.3 categ. imp., (1997), Hotarare nr. 766 din 21 noiembrie 1997 (actualizata 10 octombrie 2008) pentru aprobarea unor regulamente privind calitatea in constructii, Anexa 3-REGULAMENT privind stabilirea categoriilor de importanta a constructiilor
- [19] Met. categ. imp., (1996), Regulament Privind Stabilirea categoriei de Importanță a Construcțiilor Metodologice de Stabilire a Categoriei de Importanță a Construcțiilor, INCERC, Laborator SCB – BAP, 1996

# STUDY OF RENEWABLE ENERGY RESOURCES BY USE OF IT APPLICATIONS

Vatuiu Teodora, Associate Professor Ph.D. at „Titu Maiorescu” and researcher at  
„Polytechnic University” of Bucharest,<sup>1</sup>  
Lazaroiu Gheorghe, Professor Ph.D. at „Polytechnic University” of Bucharest

## ABSTRACT

An undeniable consequence of the industrialization of states is the growing dependence of the world's economies on the depleting energy resources of the planet. Given the fact that the world economy still depends largely on oil as a central energy resource, it is crucial to reduce EU greenhouse gas emissions and its dependence on fossil fuels and imported energy and thus contribute to the security of its energy supply.

In addition, renewable energy can play an important role as a driver of sustainable development in Romania. In our article, we found that there are potential synergies between renewable energy policy and funds designed to facilitate sustainable development, but the renewable resource management must be sustained by a computerized system that achieves efficient monitoring and analysis of energy produced from these sources.

## 1. INTRODUCTION

Renewable energy is energy generated from renewable, non-fossil based energy sources which are replenished in a human lifetime. Thus, the security of energy supply and the conservation of the traditional resources are ensured while the imports of primary energy resources are reduced significantly<sup>2</sup>.

Moreover, the usage of renewable energy stimulates the economic development at local, regional and global levels and creates new employment opportunities. Reducing environmental pollution is the major benefit of using renewable energy.

Using more renewable energy is crucial if the EU is to reduce its greenhouse gas emissions in order to comply with the 2015 Paris Agreement on Climate Change. Increasing the use of renewable energy could also reduce the EU's dependence on fossil fuels and imported energy, thus contributing to the security of its energy supply.

In an increasingly globalized economy, a country's energy policy is carried out in the context of developments and changes taking place globally.

The vision of today's European energy policy is in line with the concept of sustainable development and focuses on a number of key issues such as access for consumers to affordable and stable energy sources, sustainable development of energy production, transport and consumption, security of supply, reducing greenhouse gas emissions.

## 2. RENEWABLE ENERGY RESOURCES AND THEIR POTENTIAL

Aware of the fact that "traditional" energy resources are limited and that in the future mankind will have to move towards renewable energy sources, a strategy aimed at the

---

<sup>1</sup>Stefan cel Mare Street, no. 1, 0723660566, vatuiu\_teodora@yahoo.com

<sup>2</sup> Ion Lungu, Adela Bâra, George Cărutasu, Alexandru Pîrjan, Simona-Vasilica Oprea, *Prediction Intelligent System in the field of Renewable Energies through Neural Networks*, Economic Computation and Economic Cybernetics Studies and Research, Issue 1 Vol. 50, 2016, pag. 86

production and gradual use of green energy needs to be implemented to save scarce resources and their replacement in the future.

Renewable energy is energy generated from renewable, non-fossil based energy sources which are replenished in a human lifetime. Renewable energy sources include solar and wind energy, marine energy and hydropower, geothermal energy and bioenergy<sup>3</sup>.

The main types of renewable energy, relevant technologies and typical applications are shown in Figure 1.







<b>Solar energy</b>  Source: <b>Sun</b> Technologies: <b>Photovoltaics, Solar thermal</b> Applications: <b>Electricity, Heating and Cooling</b>	<b>Wind energy</b>  Source: <b>Wind</b> Technologies: <b>Wind turbines</b> Applications: <b>Electricity</b>	<b>Marine energy</b>  Source: <b>Waves, tides</b> Technologies: <b>Dams, tidal barrages</b> Applications: <b>Electricity</b>	<b>Hydropower</b>  Source: <b>Water</b> Technologies: <b>Hydropower plant</b> Applications: <b>Electricity</b>	<b>Geothermal energy</b>  Source: <b>Earth</b> Technologies: <b>Geothermal and heat pumps</b> Applications: <b>Electricity, Heating and Cooling</b>	<b>Bioenergy</b>  Source: <b>Biomass, waste</b> Technologies: <b>Biomass combustion, biogas plants, biofuels</b> Applications: <b>Electricity, Heating and Cooling, Transport</b>
---	---	--	--	---	---

Figure 1: Renewable energy sources, technologies and applications<sup>4</sup>

Romania has an important potential for renewable resources: hydroelectric power, biomass, solar, wind and geothermal energy.

The economically feasible hydropower potential is estimated at 23-25TWh, with an installed capacity of about 8000 MW. In 2005, the level of recovery reached about 80% of the economic potential, and hydro-energetic facilities are built, amounting to an installed capacity of about 600 MW, with a production potential of 1,870 GWh / year.

The biomass energy potential is about 7,594 thousand toe / year, of which 15,5% is forestry and firewood residues, 6,4% sawdust and other wood waste, 63,2% agricultural waste, 7,2 % household waste and 7.7% biogas.

The energy potential of solar-thermal systems is estimated at about 1,434 thousand tep / year, and that of photovoltaic systems at about 1,200 GWh / year.

The technically feasible wind potential is estimated at 8 TWh / year.

Romania has a potential of about 167 thousand tep / year of low enthalpy geothermal resources, of which at present it consumes about 30 thousand toe / year.

Energy balance indicators are developed and presented in the final energy system, a system used by EU countries and most countries in the world. Under these circumstances, the data contained in this section allows direct comparison without equivalence calculations with energy data from international statistics.

<sup>3</sup> Bioenergy energy produced from biomass. Biomass is the biodegradable fraction of products, waste and residues from biological origin from agriculture, including vegetal and animal substances, forestry and related industries including fisheries and aquaculture, as well as the biodegradable fraction of waste, including industrial and municipal waste of biological origin

<sup>4</sup> <http://publications.europa.eu/webpub/eca/special-reports/renewable-energy-5-2018/en/>

The final energy system expresses all flows based on the energy potential of each resource, showing the amounts of energy actually made available to users.

The unit of measurement used is tons of oil equivalent, this being a conventional fuel with a calorific value of 41868 kJ / kg (10000 kcal / kg).

Primary energy resources include:

- *production of primary energy carriers (net coal, crude oil, usable natural gas, firewood, hydropower, wind and solar photovoltaic, nuclear power and non-conventional sources);*
- *import of primary and transformed energy;*
- *stocks of primary energy carriers on 1 January at both producer, consumer and distribution plants.*

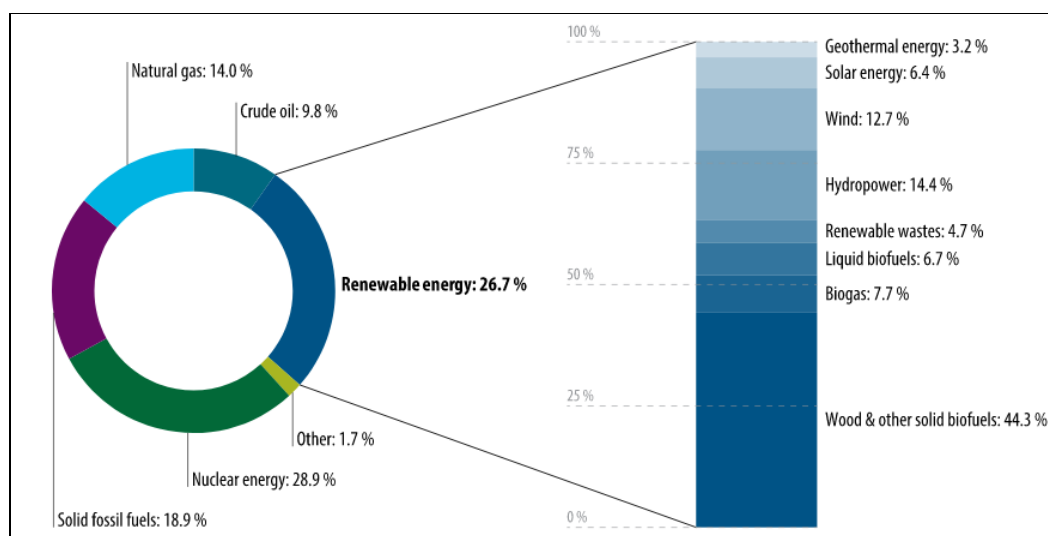

Figure 2: Production of primary energy, EU-28, 2015<sup>5</sup>

In the statistical documents, biomass sources include wood and other solid biofuels; biogas, liquid biofuels; and renewable (biodegradable) wastes.

Primary electricity is the sum of hydroelectric, nuclear, wind and solar photovoltaic, as well as electricity imports.

For hydroelectric, wind, solar photovoltaic and imported electricity, conversion to conventional fuel was based on the actual energy potential of the electricity (0.086 kg equivalent oil / kWh or 3600 kJ / kWh).

For nuclear power, primary energy is the fissionable material's energy equivalent to the output produced (considering the plant's efficiency of 35.11%, as recommended by the International Energy Agency).

The spectrum of energy resource depletion in the coming years has been a serious alarm signal and has led to the identification of the possibilities of substitution of depleting resources, the reduction of environmental imbalances caused by the exploitation, processing and utilization of the resources used so far.

This alarm signal has led mankind to operate with a new concept, the concept of energy security. For most specialists, energy security means producing the necessary energy in their own country and a reduced import dependence.

<sup>5</sup>% of total, based on tonnes of oil equivalent

Romania stands in this context as a Member State of the European Community, as a state with an industry largely based on the consumption of depleted resources, but also as a state with real possibilities to develop a renewable energy based energy structure.

Table 1: The theoretical potential of renewable energy sources in Romania <sup>6</sup>:

Renewable source	Annual potential	Application
Solar energy	60 PJ/h	Thermal Energy and Electricity
Wind power	23 TWh	Electricity
Hydro energy of which under 10 MW	36TWh 3,6TWh	Electricity
Biomass and biogas	318 PJ	Thermal Energy and Electricity
Geothermal energy	7 PJ	Thermal energy

Table 2: Production of electricity from renewable energy sources in the medium term <sup>7</sup>

Renewable sources of energy	2010 (GWh)	2015 (GWh)
Solar energy	1,860	11,600
Wind power	314	1.001
Hydro - total energy, of which: low power hydro power (max. 10 MW)	18.200 1.100	18.700 1.600
Biomass	1.134	3.654
Geothermal energy	-	-
Total	19.650	23.367
ESRE share in electricity consumption	30,00%	30,40%

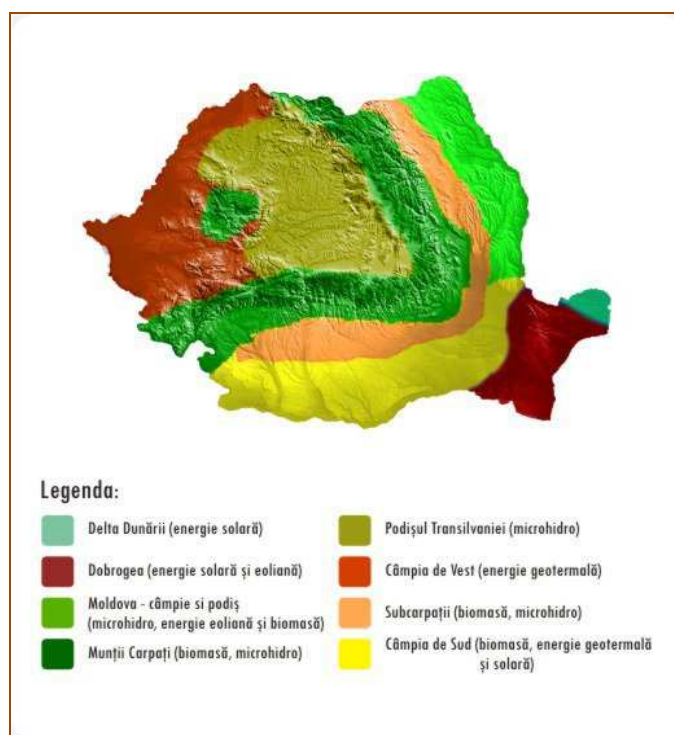

Figure 3 : Map of renewable resource potential

<sup>6</sup> Source: Romania's Energy Strategy for 2007-2020

<sup>7</sup> Eurostat, *Energy production and imports* ([http://ec.europa.eu/eurostat/statistics-explained/index.php/Energy\\_production](http://ec.europa.eu/eurostat/statistics-explained/index.php/Energy_production))

On the map, we highlight the following areas:

- *Danube Delta (solar energy);*
- *Dobrogea (solar and wind energy);*
- *Moldova (plains and plateau - microhydro, wind and biomass);*
- *Carpathian Mountains (biomass, microhydro);*
- *Transylvanian Plateau (microhydro);*
- *Western Plain (geothermal energy);*
- *Subcarpathians (biomass, microhydro);*
- *South Plain (biomass, geothermal and solar energy).*

### **3. FACILITIES OFFERED BY EXCEL FOR RENEWABLE ENERGY RESOURCES ANALYSIS**

One of the most important facilities offered by Excel for this analysis is the graphical representation in the form of diagrams of the numerical data present in a certain area of the spreadsheet.

A graph illustrates better numerical data in a spreadsheet. Graphic representations allow better visualization of relationships, trends, anomalies established between data to the extent they are illustrated by drawn shapes (lines, bars, surfaces, etc.). In this way, the data is easier to view and interpret than the mere tabular presentation of the figures studied.

The graphical representation is dynamic, ie when the data that was the basis of the graph is updated, the graphic representation is automatically updated, adjusting to the new values. Graphical representations under Excel are generated on the basis of an analysis table representing a well-defined field bounded spreadsheet, which in turn contains numerical data organized in series of data.

For the construction of a chart, the data to be graphically represented is edited and then selected, in selecting the domain that will form the basis of the graph generation, some elements (text but not only) that will constitute the diagram legends and the labels axis of the abscissa.

### **4. CONCLUSIONS**

Once considered as inexhaustible, energy and raw material resources are generally limited and unevenly distributed across the Earth.

There is also a resource scarcity law, which is that the volume, structure and quality of economic resources and goods are changing more slowly than the volume, structure and intensity of human needs. In recent years, the issue of the depletion of energy resources and energy security dominates the agendas of state leaders.

The EU's renewable energy targets of 20% final energy consumption from renewable sources by 2020, rising to at least 27% by 2030, are to be continued meth.

Renewable energy production is projected to grow steadily, from 86 TWh in 2030 to 129 TWh in 2050.

Total biomass and waste biomass production shows a consistent increase in all scenarios: from 45 TWh (14%) in 2015 to 48 TWh (16%) in 2030 and 68 TWh (24%) in 2050.

Increases will record by 2050 wind, solar and geothermal energy (currently almost non-existent).

It will also increase nuclear power production with a view to building Cernavoda reactors 3 and 4, while the hydropower sector will remain at the same level.



Coal production would drop from 55 TWh (18%) to just 12 TWh (4%) in 2050, with the international trend being less favorable to lignite and coal, amid a rise in the price for emissions certificates.

These new resources need to gradually replace traditional exhaustible resources, ensuring the protection of the natural environment and energy security. The energy sector is of vital importance for economic and social development and for improving the quality of life of the population.

Ensuring sufficient energy supply and widespread access to energy services, especially green energy from renewable sources, is a basic requirement of sustainable development.

**ACKNOWLEDGEMENTS:** This work was supported by a grant of the Romanian Ministry of Research and Innovation, CCCDI – UEFISCDI, project number PN-III-P1-1.2-PCCDI-2017-0404 / 31PCCDI/2018, within PNCDI III.

## References

- [1] Bara, A., Lungu, I., Oprea, S. V., Carutasu, G., Botezatu, C. P., Botezatu C., *Design Workflow for Cloud Service Information System for Integration and Knowledge Management Based in Renewable Energy*, Journal of Information Systems & Operations Management, Universitară Publishing; vol.8, no.2, ISSN 1843-4711, 2014.
- [2] Ellabban O., Abu-Rub H., Blaabjerg F., *Renewable energy resources: Current status, future prospects and their enabling technology*, Renewable and Sustainable Energy Reviews. 39: 748–764, 2014.
- [3] Freris, L., Infield D., *Renewable Energy in Power Systems*, Wiley, 2008.
- [4] Herczeg, M., *Renewable energy support schemes in Europe*, Copenhagen Resource Institute, 2012.
- [5] Herczeg, M., *Climate Policy Info Hub, Renewable Energy Support Policies in Europe* (<http://climatepolicyinfohub.eu/renewable-energy-support-policies-europe>), 2014.
- [6] Lazaroiu G., Traista E., Badulescu C., Orban M., Plesea V., *Sustainable combined utilization of Renewable Forest Resources and Coal in Romania*, Environmental Engineering and Management Journal, ISSN: 1582-9596, eISSN: 1843-3707, Volume: 7, Issue: 3, Pages: 227-232, 2008.
- [7] Lungu, I., Bara, A., Oprea, S. V., Carutasu, G., Pîrjan, Al., Oprea S.-V., *Prediction Intelligent System in the field of Renewable Energies through Neural Networks*, Economic Computation and Economic Cybernetics Studies and Research, Issue 1 Vol. 50, 2016.
- [8] Oanta E.M., Panait C., Lazaroiu G., Dascalescu A.-E., *Computer Aided Instrument to be used as an Automatic Design Component*, Advanced Materials Research, ISSN: 1022-6680, ISBN: 978-303835255-6, Pages 1017-1022, Volume 1036, [www.scientific.net/AMR.1036.1017](http://www.scientific.net/AMR.1036.1017), 2014.
- [9] Vătuia Teodora, Ghencea Adrian, Popeangă Vasile Nicolae, *The Integration and Interactivity of Computer Applications, a Fundamental Requirement for Creating and Maintaining the Competitive Advantage of Organizations*, Proceedings of the 2011 3rd International Conference on Future Computer and Communication (ICFCC 2011), Iasi, June, 2011, published in the conference proceeding by ASME, and included in the ASME Digital Library, and indexed by Ei Compendex and Thomson ISI Proceeding, <http://www.icfcc.org/>, 2011.
- [10] Schaubach, K., Lauer, M., *Bioenergy Development in Germany and implications of the 2017 Renewable Energy Act*, Bundesministerium für Wirtschaft und Energie, 2017.
- [11] COM 759, *Proposal for a Regulation of the European Parliament and of the Council on the governance of the Energy Union* (<https://ec.europa.eu/energy/en/news/commission-proposes-new-rules-consumer-centred-clean-energy-transition>), 2016
- [12] COM 767, *Proposal for a Directive on the promotion of the use of energy from renewable sources*, 2016
- [13] Eurostat, *Energy production and imports* ([http://ec.europa.eu/eurostat/statistics-explained/index.php/Energy\\_production\\_and\\_imports](http://ec.europa.eu/eurostat/statistics-explained/index.php/Energy_production_and_imports)).
- [14] COM 57 „*Report on progress in the field of energy from renewable sources*”, pg. 4 and 9, 2017
- [15] [http://ec.europa.eu/eurostat/statistics-explained/index.php/Renewable\\_energy\\_statistics](http://ec.europa.eu/eurostat/statistics-explained/index.php/Renewable_energy_statistics)).
- [16] [https://en.wikipedia.org/wiki/Renewable\\_energy](https://en.wikipedia.org/wiki/Renewable_energy)